

# Catalog of Assessment Methods for Evaluating the Effects of Power Plant Operations on Aquatic Communities

*Technical Report*





# **Catalog of Assessment Methods for Evaluating the Effects of Power Plant Operations on Aquatic Communities**

**TR-112013**

Final Report, June 1999

EPRI Project Manager  
D. A. Dixon

## **DISCLAIMER OF WARRANTIES AND LIMITATION OF LIABILITIES**

THIS PACKAGE WAS PREPARED BY THE ORGANIZATION(S) NAMED BELOW AS AN ACCOUNT OF WORK SPONSORED OR COSPONSORED BY THE ELECTRIC POWER RESEARCH INSTITUTE, INC. (EPRI). NEITHER EPRI, ANY MEMBER OF EPRI, ANY COSPONSOR, THE ORGANIZATION(S) NAMED BELOW, NOR ANY PERSON ACTING ON BEHALF OF ANY OF THEM:

(A) MAKES ANY WARRANTY OR REPRESENTATION WHATSOEVER, EXPRESS OR IMPLIED, (I) WITH RESPECT TO THE USE OF ANY INFORMATION, APPARATUS, METHOD, PROCESS, OR SIMILAR ITEM DISCLOSED IN THIS PACKAGE, INCLUDING MERCHANTABILITY AND FITNESS FOR A PARTICULAR PURPOSE, OR (II) THAT SUCH USE DOES NOT INFRINGE ON OR INTERFERE WITH PRIVATELY OWNED RIGHTS, INCLUDING ANY PARTY'S INTELLECTUAL PROPERTY, OR (III) THAT THIS PACKAGE IS SUITABLE TO ANY PARTICULAR USER'S CIRCUMSTANCE; OR

(B) ASSUMES RESPONSIBILITY FOR ANY DAMAGES OR OTHER LIABILITY WHATSOEVER (INCLUDING ANY CONSEQUENTIAL DAMAGES, EVEN IF EPRI OR ANY EPRI REPRESENTATIVE HAS BEEN ADVISED OF THE POSSIBILITY OF SUCH DAMAGES) RESULTING FROM YOUR SELECTION OR USE OF THIS PACKAGE OR ANY INFORMATION, APPARATUS, METHOD, PROCESS, OR SIMILAR ITEM DISCLOSED IN THIS PACKAGE.

ORGANIZATION(S) THAT PREPARED THIS PACKAGE

**EA Engineering, Science, and Technology, Inc.**

## **ORDERING INFORMATION**

Requests for copies of this package should be directed to the EPRI Distribution Center, 207 Coggins Drive, P.O. Box 23205, Pleasant Hill, CA 94523, (925) 934-4212.

Electric Power Research Institute and EPRI are registered service marks of the Electric Power Research Institute, Inc. EPRI. POWERING PROGRESS is a service mark of the Electric Power Research Institute, Inc.

Copyright © 1999 Electric Power Research Institute, Inc. All rights reserved.

# CITATIONS

---

This report was prepared by

EA Engineering, Science, & Technology, Inc.  
15 Loveton Circle  
Sparks, MD 21152

Principal Investigators

W. Rue  
J. Boltz  
J. Boraczek  
W. Dey  
L. Jensen  
D. Mayhew  
P. Muessig  
E. Perry  
B. Rue

This report describes research sponsored by EPRI

This report is a corporate document that should be cited in the literature in the following manner:

*Catalog of Assessment Methods for Evaluating the Effects of Power Plant Operations on Aquatic Communities*, EPRI, Palo Alto, CA: 1999. TR-112013.



# REPORT SUMMARY

---

This report documents the current state of knowledge on methods for assessing the effects of stressors on the health, function, integrity and quality of aquatic populations and ecosystems. This information will be valuable to industry, resource agencies, non-governmental environmental organizations, and universities involved in research, management and protection of aquatic resources.

## **Background**

During the late 1970s and early 1980s, EPRI supported similar studies that evaluated scientific methodologies and summarized the potential environmental effects of power plant operations. These studies generated annotated bibliographies of impingement, entrainment, and thermal and chemical effects of power plant cooling water systems; examined population and ecosystem effects of impingement and entrainment; and critically reviewed the literature on mathematical models that evaluated the natural compensatory mechanisms of fish populations as a result of power plant induced mortality. Advances in impact assessment techniques were further promoted through dialogue among utility personnel, consultants, and regulators in a series of EPRI-supported workshops during the same period. During the nearly 20 years since publication of those early reviews, studies, and symposia, much has been learned about perturbations to aquatic resources related to power plant operation, and the number and sophistication of analytical methods applied in these studies has continued to increase and evolve. In addition, during the past decade, methods for ecological risk assessment have been the subject of extensive development and standardization receiving attention from the scientific, regulatory, and political communities. This report updates those early EPRI-sponsored reviews and the subsequent advances in the science of power plant impact assessment techniques.

## **Objectives**

- To catalog and review state-of-the-art methods available for analysis, estimation, prediction, and interpretation of aquatic population data
- To assess the effects of various power plant operations on aquatic ecosystems under a variety of conditions and circumstances (for example, impingement and entrainment by cooling water intake structures, thermal discharges, and chemical releases).

---

## **Approach**

The project was conducted in two phases. Phase 1 reviewed published and unpublished literature in an effort to identify relevant predictive models, statistical analyses, and indices of biotic integrity. Technical experts in ecological risk assessment and resource management were contacted in an effort to ensure relevant methods were not overlooked. Under Phase 2 of the project, identified methods were reviewed in detail with regard to potential utility for estimation of power plant operational effects. Specific factors addressed as part of the objective characterization of each method included nature and type of questions and issues addressed, data input requirements, inherent assumptions, scope of method, taxa applicability, peer review and/or use in regulatory setting, level of expertise required to employ, and relative cost to employ.

## **Results**

Cataloged methods are classified as either predictive or retrospective. Predictive methods are used as tools to predict changes in aquatic biological resources in the future, to extrapolate to higher ecological levels, or to predict changes under alternative power plant operation scenarios. Retrospective methods are typically employed to measure or test for differences among sets of empirical data that may be related to the operation of a power plant, as well as to characterize a pre-operational baseline condition. Each of the methods are described in detail and then followed by selected example applications. The report is not a user's manual for the methods identified, but rather a descriptive catalog of available methods. A comprehensive bibliography provides references for more detailed information on use and implementation of specific methods.

## **EPRI Perspective**

The methods and information presented in this catalog will be a valuable resource tool for utility managers when selecting appropriate data assessment methods for measuring changes in aquatic resources associated with power plant operation. This catalog will also be an objective resource for a diversity of users involved in the regulatory process, including scientists, engineers, managers, and lawyers working for the electric utility industry; regulatory agencies, resource management agencies, academic and private consultants; and non-governmental environmental organizations.

## **TR-112013**

### **Keywords**

316 Issues

Ecology

Population modeling

Fisheries

Environmental impact analysis

Environmental risk analysis



## ACKNOWLEDGMENTS

---

The authors of this report wish to thank Doug Dixon, Kent Zammit, and Bob Brocksen of EPRI for their support and guidance during the preparation of the report.

Also, special thanks to Jim Wright and Gary Hickman (Tennessee Valley Authority); Mark Strickland, Maureen Vaskis, and John Balletto (Public Service Electric and Gas Company); Dave Bailey and Jules Loos (Potomac Electric Power Company); Nat Wooding (Virginia Power); Terry Hogan (Indianapolis Power and Light Company); Kristy Bulleit (Utility Water Act Group/Hunton & Williams); Mark Peterson and Webb Van Winkle (Oak Ridge National Laboratory); and Lev Ginzburg (Applied Biomathematics) for their perseverance in reviewing and editing the draft versions of this report. Special thanks are also owed to members of EPRI's Clean Water Act Section 316(b) Technical Advisory Team and members of the Utility Water Act Group Cooling Systems Technical Committee for their general comments and recommendations on the report's structure and content.

The report was compiled and edited by EA Engineering, Science, & Technology, Inc..



# CONTENTS

---

<b>1</b>	<b>INTRODUCTION.....</b>	<b>1-1</b>
1.1	Objectives and Scope of This Report .....	1-1
1.2	Previous Reviews of Impact Assessment Methods.....	1-4
<b>2</b>	<b><i>PREDICTIVE METHODS</i>.....</b>	<b>2-1</b>
2.1	Overview .....	2-1
2.2	Individual Losses.....	2-3
2.2.1	Equivalent Adult Model.....	2-3
2.2.2	Lost Reproductive Potential.....	2-6
2.2.3	Production Forgone .....	2-9
2.3	Fractional Losses .....	2-12
2.3.1	Habitat Ratio Approach.....	2-13
2.3.1.1	Water Volume Ratio.....	2-13
2.3.1.2	Affected Area/Volume Ratio.....	2-15
2.3.2	Exploitation Rate/Fractional Cropping Rate .....	2-18
2.3.3	Conditional Mortality Rates.....	2-22
2.3.3.1	Abundance-Weighted Affected Area/Volume Ratio.....	2-23
2.3.3.2	Empirical Transport Model.....	2-27
2.3.3.3	Empirical Impingement Model.....	2-32
2.3.4	Hydrodynamic Models .....	2-34
2.3.4.1	Thermal Induced Plume Effects Model .....	2-36
2.3.4.2	Generalized Hydrodynamic Transport Model .....	2-37
2.3.4.3	Potomac River Model.....	2-37
2.3.4.4	Cape Fear FPM.....	2-38
2.3.4.5	Hudson River Striped Bass Life Cycle Model.....	2-38
2.3.4.6	Real-Time Life Cycle Model.....	2-40
2.3.4.7	Winter Flounder Stochastic Population Dynamics Model .....	2-40

---

2.4	Population Projections.....	2-41
2.4.1	Composite Models.....	2-42
2.4.1.1	Stock-Recruitment Models.....	2-43
2.4.1.2	Logistic Population Growth Model.....	2-50
2.4.1.3	Yield-Per-Recruit .....	2-51
2.4.2	Age/Cohort-Structured Models.....	2-53
2.4.2.1	Matrix Models .....	2-53
2.4.3	Individual-Based Models.....	2-59
2.5	Ecosystem/Community Models .....	2-66
2.5.1	Food Chain Production Projections.....	2-72
2.5.2	Community/Ecosystem Models.....	2-73
<b>3</b>	<b>RETROSPECTIVE METHODS .....</b>	<b>3-1</b>
3.1	Overview.....	3-1
3.2	Metric-Based and Index Approaches.....	3-2
3.2.1	Index of Biotic Integrity (IBI).....	3-5
3.2.2	Other Fish Community and Population Indices .....	3-10
3.2.2.1	Family Level Ichthyoplankton Index Methods ( $I^2$ ).....	3-10
3.2.2.2	Reservoir Fish Assemblage Index (RFAI) .....	3-11
3.2.2.3	Index of Well Being (Iwb).....	3-12
3.2.2.4	Sport Fishing Index.....	3-13
3.2.2.5	Fish Assessment Protocols for RBP .....	3-14
3.2.3	Rapid Bioassessment Protocols (RBP).....	3-14
3.2.4	Other Benthic Community Indices.....	3-19
3.2.4.1	Hilsenhoff Biotic Index (HBI) .....	3-20
3.2.4.2	Community Loss Index (CLI).....	3-20
3.2.4.3	Invertebrate Community Index (ICI) .....	3-21
3.2.4.4	Benthic IBI (B-IBI) for Chesapeake Bay .....	3-21
3.2.4.5	MACS Workshop Method .....	3-22
3.2.5	Fish Health Assessments .....	3-24
3.2.6	Diversity Indices .....	3-26
3.2.7	Other Metric-Based Approaches.....	3-27
3.2.7.1	Algal Assessments .....	3-27
3.3	Hypothesis Testing Statistics.....	3-28
3.3.1	General Discussion of Group Comparison Methods .....	3-28

---

3.3.1.1 Statistical Logic.....	3-28
3.3.1.2 Study Design Concepts .....	3-29
3.3.1.3 Pseudo-Replication.....	3-30
3.3.1.4 Multiple Comparisons .....	3-30
3.3.1.5 Statistical Power .....	3-31
3.3.1.6 Statistical Significance vs. Biological Significance.....	3-31
3.3.2 Normal Theory Methods (Parametric Methods) .....	3-32
3.3.2.1 Data Requirement.....	3-32
3.3.2.2 Assumptions .....	3-32
3.3.2.3 Specific Normal Theory Tests .....	3-35
3.3.3 Nonparametric Methods .....	3-39
3.3.3.1 Concepts and Assumptions .....	3-39
3.3.3.2 Individual Nonparametric Procedures .....	3-39
3.3.4 Tests for Frequencies and Proportions .....	3-41
3.3.4.1 General Concepts and Assumptions.....	3-42
3.3.4.2 Examples of Tests for Discrete Data.....	3-42
3.4 Trends Analysis.....	3-43
3.4.1 Graphical and Nonparametric Techniques.....	3-44
3.4.1.1 Run-Sequence Plot.....	3-44
3.4.1.2 Smoothing .....	3-44
3.4.1.3 Nonparametric Trend Test .....	3-44
3.4.2 Regression Analysis .....	3-45
3.4.2.1 Simple Linear Regression.....	3-45
3.4.2.2 Multiple Linear Regression .....	3-46
3.4.2.3 Polynomial Regression .....	3-47
3.4.2.4 Multivariate Regression .....	3-48
3.4.2.5 Transformations.....	3-48
3.4.3 Time Series Analysis .....	3-49
3.4.4 Other Trend Methods.....	3-51
3.5 Multivariate Analysis.....	3-51
3.5.1 Classification and Multivariate Proximity .....	3-52
3.5.1.1 Distance and Similarity Measures.....	3-52
3.5.1.2 Clustering .....	3-53
3.5.1.3 Graphical Methods.....	3-54

---

3.5.2 Correlation and Linear Structure .....	3-56
3.5.2.1 Principal Components Analysis.....	3-56
3.5.2.2 Factor Analysis .....	3-57
3.5.2.3 Ordination .....	3-58
3.5.2.4 Canonical Variate Analysis .....	3-58
3.5.2.5 Discriminant Analysis.....	3-59
3.6 Fisheries Management Assessments .....	3-60
3.6.1 Available Prey/Predator Ratio (AP/P) .....	3-60
3.6.2 Young/Adult Ratio (YAR) .....	3-62
3.6.3 Proportional Stock Density (PSD) .....	3-63
3.6.4 Relative Stock Density (RSD) .....	3-64
3.6.5 Relative Weight (Wr).....	3-65
3.6.6 Other Fisheries Management Techniques .....	3-68
<b>4 REFERENCES.....</b>	<b>4-1</b>

## LIST OF FIGURES

---

Figure 2-1 Generic examples of Ricker and Beverton-Holt type stock recruitment curves. ....	2-78
Figure 2-2 Generic example of logistical growth curve (A) and associated parabolic relationship (B) between yield (effort) and stock size. ....	2-79
Figure 2-3 Relationship between population growth rate of young of the year Hudson River striped bass and catch per unit of sampling effort. (From LMS 1980a) .....	2-80
Figure 2-4 Developmental steps involved in model construction. (Adapted from LMS 1980b) .....	2-81
Figure 2-5 Diagram of the model-building process. (From Hall and Day 1977).....	2-82
Figure 2-6 Aggregated food chain model for wetland-based aquatic food chain in the Delaware Estuary. (From PSE&G 1993a).....	2-83
Figure 2-7 Conceptual interaction between a power plant and coastal ecosystem, including the economic and energy costs associated with cooling towers. (From Kemp 1981).....	2-84
Figure 2-8 Conceptual diagram of trophic web in an estuarine ecosystem near Crystal River power plant. (From Kemp 1981) .....	2-85
Figure 2-9 Trophic-level diagram derived by transforming quantitative data associated with food-web model depicted in Figure 2-8. (From Kemp 1981).....	2-86
Figure 2-10 Model for estimation of the ecosystem effects associated with population losses due to entrainment at Morgantown power plant. (From Polgar et al. 1981).....	2-87
Figure 2-11 Diagram of ECOIMP model showing various components and their relationships. (From Logan and Kleinstreuer 1981) .....	2-88
Figure 2-12 Schematic conceptual foreview of the Patuxent Estuarine Trophic Simulation (PETS) model. (From Summers 1989) .....	2-89
Figure 3-1 Relationship between habitat quality and biological condition. ....	3-70
Figure 3-2 The Pythagorean theorem provides a tool for measuring distance in two dimensional space.....	3-71
Figure 3-3 Multivariate data displayed in parallel axis graph. ....	3-72
Figure 3-4 Multivariate data displayed in star graph. ....	3-73
Figure 3-5 Illustration of the concept of principle component analysis for a two dimensional data set.....	3-74
Figure 3-6 Logarithmic plots of available prey:predator (AP/P) for three general conditions: (A) excess prey for all lengths of predators; (B) prey deficiencies for all lengths of predators; and (C) prey adequacy for small predators but excess for	

---

large predators (>20 cm). Diagonal dashed line indicates the minimum desirable AP/P ratio. Numbers along the curves are predator lengths (cm), and points represent 2.5-cm length increments. From Anderson and Neuman (1996) based upon Jenkins and Morais (1978) and Noble (1981). ..... 3-75



## LIST OF TABLES

Table 2-1 Summary of Method Characteristics: Equivalent Adult Model.....	2-90
Table 2-2 Summary of Method Characteristics: Lost Reproductive Potential Model.....	2-91
Table 2-3 Summary of Method Characteristics: Production Foregone Model .....	2-92
Table 2-4 Summary of Method Characteristics: Water Ratio .....	2-93
Table 2-5 Summary of Method Characteristics: Habitat Area/Volume Ratio .....	2-94
Table 2-6 Summary of Method Characteristics: Exploitation Rates .....	2-95
Table 2-7 Summary of Method Characteristics: Abundance Weighted Affected Area/Volume Ratio .....	2-96
Table 2-8 Summary of Method Characteristics: Empirical Transport Model.....	2-97
Table 2-9 Summary of Method Characteristics: Empirical Impingement Model .....	2-98
Table 2-10 Summary of Method Characteristics: Hydrodynamic Models.....	2-99
Table 2-11 Summary of Method Characteristics: Stock Recruitment Models.....	2-100
Table 2-12 Summary of Method Characteristics: Logistic Population Growth Model .....	2-101
Table 2-13 Summary of Method Characteristics: Yield-Per-Recruit Model .....	2-102
Table 2-14 Summary of Method Characteristics: Age/Cohort Structured Models (Leslie Matrix) .....	2-103
Table 2-15 Summary of Method Characteristics: Individual-Based Models .....	2-104
Table 2-16 Summary of Method Characteristics: Community/Ecosystem Models .....	2-105
Table 3-1 Index of Biotic Integrity (IBI) (also RBP Fish Assessments).....	3-76
Table 3-2 Example of Trophic Group and Tolerance Designation of Selected Fish Species .....	3-77
Table 3-3 Fish IBI Metrics Used in Various Regions of North America .....	3-78
Table 3-4 Family Level Ichthyoplankton Index Methods ( $I^2$ ).....	3-79
Table 3-5 Reservoir Fish Assemblage Index (RFAI).....	3-80
Table 3-6 Index of Well-Being (IWB) and Modified IWB .....	3-81
Table 3-7 Sport Fishing Index (SFI) .....	3-82
Table 3-8 Rapid Bioassessment: Invertebrate Protocols (Single and Multihabitat Approaches).....	3-83
Table 3-9 Examples of Metric Suites Used for Analysis of Macroinvertebrate Assemblages.....	3-85
Table 3-10 Rapid Bioassessment: Biological Reconnaissance (BioRecon).....	3-86
Table 3-11 Hilsenhoff Biotic Index.....	3-87

---

Table 3-12 Invertebrate Community Index (ICI).....	3-88
Table 3-13 Benthic IBI for Chesapeake Bay (B-IBI).....	3-89
Table 3-14 MACS Workshop Method.....	3-90
Table 3-15 Fish Health Assessments.....	3-91
Table 3-16 Rapid Bioassessment: Algal Assessments (Periphyton).....	3-92
Table 3-17 Summary of Method Characteristics: T-Test .....	3-93
Table 3-18 Summary of Method Characteristics: Paired T-Test .....	3-94
Table 3-19 Summary of Method Characteristics: ANOVA .....	3-95
Table 3-20 Summary of Method Characteristics: Randomized Block Analysis .....	3-96
Table 3-21 Summary of Method Characteristics: Factorial ANOVA.....	3-97
Table 3-22 Summary of Method Characteristics: Split Plot ANOVA .....	3-98
Table 3-23 Summary of Method Characteristics: Repeated Measures ANOVA.....	3-99
Table 3-24 Summary of Method Characteristics: MANOVA .....	3-100
Table 3-25 Summary of Method Characteristics: ANCOVA.....	3-101
Table 3-26 Summary of Method Characteristics: Wilcoxon Rank Sum Test .....	3-102
Table 3-27 Summary of Method Characteristics: Sign Test.....	3-103
Table 3-28 Summary of Method Characteristics: Wilcoxon Signed Rank Test .....	3-104
Table 3-29 Summary of Method Characteristics: Kruskal Wallis Test.....	3-105
Table 3-30 Summary of Method Characteristics: Friedman Test.....	3-106
Table 3-31 Summary of Method Characteristics: ANOVA of Ranks .....	3-107
Table 3-32 Summary of Method Characteristics: Randomization Tests.....	3-108
Table 3-33 Summary of Method Characteristics: Bootstrapping.....	3-109
Table 3-34 Summary of Method Characteristics: Test for Proportions.....	3-110
Table 3-35 Summary of Method Characteristics: Fisher's Exact Test.....	3-111
Table 3-36 Summary of Method Characteristics: 2-Way Chi-Square Test.....	3-112
Table 3-37 Summary of Method Characteristics: Multiway Chi-Square Test .....	3-113
Table 3-38 Summary of Method Characteristics: Log-Linear Models .....	3-114
Table 3-39 Summary of Method Characteristics: Mann-Kendall Test.....	3-115
Table 3-40 Summary of Method Characteristics: Seasonal Kendall Test .....	3-116
Table 3-41 Summary of Method Characteristics: Van Belle and Huges Test.....	3-117
Table 3-42 Summary of Method Characteristics: Simple Linear Regression .....	3-118
Table 3-43 Summary of Method Characteristics: Multiple Linear Regression.....	3-119
Table 3-44 Summary of Method Characteristics: Polynomial Regression.....	3-120
Table 3-45 Summary of Method Characteristics: Multivariate Regression.....	3-121
Table 3-46 Summary of Method Characteristics: Time Series Methods .....	3-122
Table 3-47 Summary of Method Characteristics: Cluster Analysis .....	3-123
Table 3-48 Summary of Method Characteristics: Multivariate Graphical Methods .....	3-124
Table 3-49 Summary of Method Characteristics: Principal Components Analysis .....	3-125

---

Table 3-50 Summary of Method Characteristics: Factor Analysis.....	3-126
Table 3-51 Summary of Method Characteristics: Ordination .....	3-127
Table 3-52 Summary of Method Characteristics: Canonical Correlation.....	3-128
Table 3-53 Summary of Method Characteristics: Discriminant Analysis .....	3-129
Table 3-54 Summary of Method Characteristics: Available Prey/Predator Ratio (AP/P) .....	3-130
Table 3-55 Summary of Method Characteristics: Young/Adult Ratio (YAR).....	3-131
Table 3-56 Summary of Method Characteristics: Proportional Stock Density (PSD).....	3-132
Table 3-57 Summary of Method Characteristics: Relative Stock Density (RSD).....	3-133
Table 3-58 Summary of Method Characteristics: Relative Weight.....	3-134



# 1

## INTRODUCTION

---

### 1.1 Objectives and Scope of This Report

Methods for assessing the function, integrity and quality of aquatic populations, communities, and ecosystems, and for assessing the effects of stressors, are presented in this catalog. Specifically, this document focuses on methods which are available to analyze, estimate, predict and interpret aquatic biological data to assess the effects of various power plant operations on aquatic ecosystems under a variety of conditions and circumstances (e.g., effects of cooling water intake structures [CWIS], thermal discharges, and chemical releases). Approaches to determine whether a measured response constitutes an adverse or otherwise unacceptable environmental impact are not addressed in this document.

Each method is described in detail, and then followed by selected example applications. The discussion of each method includes a characterization of the following factors:

- Type of question or technical issue addressed by the method or application
- Ecosystems to which the method may be applicable (e.g., streams, estuaries)
- Data input requirements, including type, duration, amount, and special data collection conditions
- Inherent assumptions, and ramifications of violating those assumptions
- Scope of method (i.e., population, or community/ecosystem level)
- Taxa or Representative Important Species (RIS) for which it is appropriate or inappropriate
- Previous applications for power plants or analogous sites
- Acceptance through peer review or by involved parties in a regulatory setting
- Level of expertise required to implement

- Relative cost to implement
- Qualitative or quantitative nature of results
- Associated variability and uncertainty of results
- Relationship to other methods.

This report should not be considered a “users manual” for the methods identified, but rather a descriptive catalog of methods that are available. It is recommended that users selecting among methods identified in this document refer to the primary literature citations provided for more detailed information on the use and implementation of the methods, as well as proper evaluation of the resulting data.

Although a clean division is not always evident, the available methods can generally be classified as either predictive (Chapter 2) or retrospective (Chapter 3) in nature.

- Predictive methods, although they may use historical empirical data as the basis for model construction, are used as tools to predict changes in aquatic biological resources in the future, to extrapolate to higher ecological levels, or to predict changes under alternative power plant operation scenarios.
- In contrast, retrospective methods are typically employed to measure or test for differences among sets of empirical data (e.g., control/experimental, upstream/downstream, nearfield/farfield) that may be related to the operation of a power plant, as well as to characterize a pre-operational baseline condition or to evaluate integrity and health.

The predictive and retrospective methods categories discussed in this report are as follows:

- PREDICTIVE METHODS
  - Individual Losses
    - Equivalent Adult Model
    - Lost Reproductive Potential
    - Production Forgone
  - Fractional Losses
    - Habitat Ratio Approaches

- Water Volume Ratio
- Affected Area/Volume Ratio
- Exploitation Rate
- Conditional Mortality Rates
  - Abundance-Weighted Affected Area/Volume Ratio
  - Empirical Entrainment
  - Empirical Impingement
- Hydrodynamic Models
- Population Projections
  - Composite Models
  - Age/Cohort-Structured Models (e.g., RAMAS®)
  - Individual Based Models (e.g., CompMech)
  - Ecosystem/Community Models
- RETROSPECTIVE METHODS
  - Metric-Based Approaches (e.g., RBP, IBI, ICI)
    - Fish Indices
    - Invertebrate Indices
    - Algal Indices
  - Statistical Methods
    - Hypothesis Testing Statistics
    - Trend Analyses
    - Multivariate Analyses
  - Fisheries Management Assessments

Some of the methods discussed have been used in both retrospective and predictive assessment applications. Fisheries management models, for example, are applied to long-term annual monitoring data to evaluate historical population trends and patterns; however, once constructed and calibrated using historical data, the basic population model can be a valuable predictive tool for evaluating short- and long-term changes on a population. For power plants that have not yet begun operation, or which anticipate substantial operational changes, predictive methods may be the most appropriate assessment option (although retrospective methods may be valuable to help determine pre-operational baseline conditions). For existing power plants, many of which have been in operation for 20 years or more, retrospective methods that measure the observed effects on the aquatic resources or ecosystem at risk can be preferable for evaluating the cumulative observed effect on a population or ecosystem over the operational history of the plant. Even with existing power plants, however, impact assessments can effectively use predictive methods only, or use a combination of both predictive and retrospective methods; e.g., as part of a weight-of-evidence approach for assessing the potential for adverse environmental risks (Suter et al. 1993; U.S. EPA 1996a).

The Electric Power Research Institute's (EPRI's) goal is that this document become a valuable resource tool to help utility managers in the selection of appropriate data assessment methods for evaluating aquatic populations, communities, or ecosystems and assessing potential effects of power plant operation. It is also EPRI's intent that this document be accepted as an objective resource by a diversity of users involved in the regulatory process, including scientists, engineers, managers, and lawyers working for the utility industry, regulatory agencies, resource management agencies, academic and private consultants, and environmental advocates.

## **1.2 Previous Reviews of Impact Assessment Methods**

During the late 1970s and early 1980s, the EPRI supported many studies that evaluated scientific methodologies and summarized the potential environmental effects of power plant operations. These earlier studies examined effects of entrainment on phytoplankton and zooplankton (Lawler, Matusky and Skelly Engineers [LMS] 1979a), and population and ecosystem changes related to cooling water operations (LMS 1980a,b). During this same period, Battelle's Pacific Northwest Laboratories (1979) synthesized information for EPRI on the ecological effects of power plant operations on cooling water impoundments. Oak Ridge National Laboratory and the Atomic Industrial Forum (1979a,b,c,d) under EPRI support, generated annotated bibliographies of impingement, entrainment, thermal and chemical effects of power plant cooling water systems on aquatic organisms. An EPRI-supported critical review of the literature on mathematical models to evaluate fish compensation mechanisms was performed by SYSTECH Engineering (1987). In addition, EPRI collected and cataloged the considerable scientific and "gray" literature generated by utility industry studies



and created a centralized information resource, the Cooling System Effects Database (Atomic Industrial Forum 1978).

Advances in impact assessment techniques were further promoted through dialogue among utilities, consultants, and regulators in a series of EPRI-supported workshops conducted during the late 1970s (Jensen 1974, 1976, 1978, 1980). In addition, Barnthouse et al. (1988) edited an American Fisheries Society monograph reviewing the controversial decade-long history of power plant impact assessments on the Hudson River.

In addition to cataloging methods and available literature, EPRI has also supported the evaluation and development of models for assessing power plant-related effects on aquatic populations (Van Winkle 1977; Science Applications, Inc 1982; Jude et al. 1987; Saila et al. 1987; SYSTECH Engineering 1987; R.G. Otto & Associates and Science Applications International Corporation 1987). More recent EPRI studies have included a summary of EPRI cooling system effects research that was conducted between 1975 and 1993 (Woodis Associates 1994), and EPRI's power plant intake systems database bibliography which contains citations to more than 4,000 references (TETRA TECH 1997).

During the nearly 20 years since publication of those early reviews, studies, and symposia, much has been learned about perturbations to aquatic resources related to power plant operation, and the number and sophistication of analytical methods applied in these studies has continued to increase and evolve. In particular, during the past decade, methods for ecological risk assessment have been the subject of extensive development and standardization receiving attention from the scientific and regulatory communities (Suter et al. 1993; U.S. EPA 1996a). Many of these methods appear to have direct applicability to estimating power plant-related effects (Saila et al. 1997). This report supplements those earlier reviews and the subsequent advances in the state of the science of power plant impact assessment techniques by cataloging both traditional and more recently developed data assessment methods for evaluating aquatic populations, communities, and ecosystems and potential effects of power plant operations.



# 2

## PREDICTIVE METHODS

---

### 2.1 Overview

This group of assessment methods includes those that can be used to predict changes in populations, communities, or ecosystems associated with power plant operations. Many of these methods express predicted changes as losses, that is, a change in mortality/survival rates or a reduction in the size of the initial population, typically on some relative or proportional basis. While predictive methods provide a well documented means of estimating power-plant-related effects, the level of uncertainty associated with many of these methods can be relatively high, if assumptions and model parameters are not readily measurable. For some methods, certain assumptions are often found or accepted to be not valid; in some cases it is possible to quantify the level of uncertainty associated with these conditions.

One concept generally accepted, at least on a theoretical level, in the study of populations, particularly in terrestrial systems, is that of compensation (McFadden 1977, McFadden et al. 1978, Jude et al. 1987, R.G. Otto & Associates and Science Applications International Corporation 1987, Saila et al. 1987, Christensen and Goodyear 1988, Nesbit et al. 1990, Rothschild 1998), i.e., the influence of density dependent processes on population growth and dynamics. Some of the population models presented in Sections 2.4.2 and 2.4.3. attempt to account for the effect of compensatory mechanisms on aquatic populations; however, many population models assume that compensation does not occur. Ignoring compensation in estimating power-plant-related effects at the population-level can be a significant source of uncertainty in an assessment and typically results in an overestimate of the magnitude of the effect if compensatory mechanisms are a factor. In some cases, estimates of power plant-related losses without compensation have predicted eventual depletion and extinction of some populations; however, data from long term monitoring programs in several cases have provided no evidence of such population collapses.

Faced with such uncertainty, impact assessors frequently tend to err on the conservative side in selecting input parameters, which generally results in an overestimate of potential or expected effects. This inherent uncertainty, together with the context of the study, must be carefully considered in the overall impact assessment process. Methods such as stochastic modeling and Monte Carlo can now be applied to the quantification

of the influence of uncertainty, as well as, data variability on model results by incorporating value ranges or distributions as model input rather than single discrete values. These methods are also applicable for evaluation of issues as to the sensitivity of methods to detect significant changes in selected critical biological parameters.

There is a parallel between the complexity of the biotic system being assessed (from individuals, to population, to community/ecosystem), the complexity of the field studies and data requirements, and the evolutionary development of the assessment methods. Early power plant studies typically relied on census surveys (species and numbers) and expressed impacts in terms of simple counts or estimates of the number of organisms affected (e.g., entrained or impinged). As our understanding of communities and ecosystems increased and data has accumulated, researchers have perceived the need to conduct assessments at increasing levels of system complexity, first from the individual to the population level and, eventually, at the community and ecosystem levels:

- The simplest assessments are made on the individual organism level (that is, the number of individual organisms affected), with only minimal attention to life history or population trends.
- Increasing in complexity, assessment of population-level effects is one of the key tools in both classical resource management and impact assessment studies. Population-level effects can be assessed in terms of either a fractional decrease of the current population, or a reduction in the long-term abundance, yield, or probability of persistence of the population of interest.
- Community or ecosystem-level modeling has been applied on only a limited basis for predictive impact assessments because it is still very much an emerging science and owing to the relative complexity of these models, extensive information and computational requirements, and associated costs.

Enabling this evolution has been the growth of computational capabilities associated with the progressive development of accessible, user-friendly computer hardware and software.

This chapter summarizes methods which have direct practical applicability to evaluating power-plant-related changes in populations and communities. Thus, only methods which have demonstrated use in assessing power plant-related effects, or directly analogous problems, are included. It is not within the scope of this document to develop new methods or attempt to bring theoretical modeling exercises to bear on the question of predicting power-plant-related effects.

Predictive methods are categorized and discussed as follows: individual losses (Section 2.2), fractional losses (Section 2.3), population projections (Section 2.4), and ecosystem/community models (Section 2.5).

## **2.2 Individual Losses**

Estimation of actual individual losses often has been a first step for all predictive methods. Individual losses are based upon empirical counts from samples of impingement and entrainment, or estimates of exposure to power plant effluents, that are extrapolated where necessary, to reflect operating scenarios other than those under which they were conducted. Individual loss estimates can be made for either a particular species or group of species (e.g., river herring). Such estimates often become the basis of higher level (population or community) assessments. For example, estimates of individual loss can easily be converted to estimates of “fractional loss” (Section 2.3) by dividing the number lost by the coincident number in the population. Assessment techniques at the individual level include a variety of methods including the following:

- Equivalent adult losses (Section 2.2.1)
- Lost reproductive potential (Section 2.2.2)
- Production forgone (Section 2.2.3)

Each of these techniques is described below.

### **2.2.1 Equivalent Adult Model**

The Equivalent Adult Model (EAM) provides a mechanism to extrapolate estimates of direct loss of various lifestages for a species (e.g., estimates of lifestage specific entrainment or impingement losses, estimates of numbers lost due to exposure to elevated temperatures or chemical toxicity) to an equivalent number of organisms lost at some other lifestage (Table 2-1). For example, the model would allow a researcher to extrapolate the number of eggs and larvae lost through entrainment to an equivalent number of individuals that would otherwise have survived to be adults. While the model name refers to equivalent adults, this method can be used to extrapolate entrainment-related losses in terms of any specified lifestage. The EAM provides a method by which power-plant-related losses can be related to “real world” measures, such as harvests by commercial or recreational fisheries, or estimated production of young.

Equivalent losses are calculated with the EAM using estimates of lifestage-specific power plant related losses and estimates of lifestage-specific total mortality rates

following the methods first described by Horst (1975) and later refined and expanded by Goodyear (1978). Mathematically, these equivalent losses are defined as follows:

$$EL = \sum_{i=1}^I (S_i \times N_i) \quad (\text{eq. 2-1})$$

where:

EL = Estimated equivalent loss in numbers

$S_i$  = Expected survival rate from lifestage (I) to the lifestage of equivalence

$N_i$  = Number of individuals of lifestage (I) directly lost as a result of power plant operation

I = Total number of lifestages (I) directly affected by power plant operations.

Typically, lifestage-specific direct losses ( $N_i$ ) are estimated from site-specific studies, such as entrainment and impingement monitoring programs, or based on estimated exposures to lethal levels of pollutants such as heat or toxic chemicals determined from site-specific aquatic toxicity testing or review of the scientific literature. Estimates of lifestage specific survival ( $S_i$ ) are typically based on information available from the scientific literature, although survival estimates based on site-specific studies (e.g., catch curve analysis) also can be used. Although not specifically a prerequisite of the EAM, equivalent losses are commonly developed under the assumption that the population of interest is at equilibrium levels. That is, the number of adults recruited to the population each year is just sufficient to replace those adults which die during the year such that the overall population neither increases nor decreases. While it is true that, in reality, populations are rarely at equilibrium levels, it is reasonable to assume that most populations will fluctuate around these equilibrium levels on a long term basis.

The assumption that the population is at equilibrium levels assures consistency and comparability in the application of the EAM in three ways. First, consistent use of the equilibrium assumption will ensure direct comparability among EAM estimates generated for different species and by different researchers. Second, the equilibrium assumption allows for an internal check of consistency among available estimates of lifestage-specific survival such that the same answer is generated going both forward and backward in the life cycle. Finally, it is rare that lifestage-specific survival rates (which are essential input for the EAM) are available for all lifestages of a species of interest. The equilibrium assumption provides a mechanism for the fishery scientist to estimate missing lifestage-specific survival rates in a consistent manner.

Under the assumption that the population is at equilibrium levels, each female produces enough eggs over her life time to replace herself and, assuming an approximately 1:1 sex ratio, her mate. Thus, the total survival rate from egg to adult can be calculated based on estimated life-time egg deposition as:

$$S_{egg \rightarrow adult} = \frac{2}{Eggs_{total}} \quad (\text{eq. 2-2})$$

where:

$S_{egg \rightarrow adult}$  = estimated survival (proportion) from egg to adult

$Eggs_{total}$  = total life time egg deposition for a single female.

Estimates of total life time egg deposition for a female are typically generated using a life table approach which incorporates age-specific information on mortality, maturity, and fecundity for adult females of the species of interest. Using the resulting estimate of egg to adult survival, together with information on the expected pattern in life-time mortality and expert judgment, a reasonable overall survival curve can be generated for use in the EAM even when a considerable number of the required lifestage-specific survival estimates are unavailable.

In practice, the selection of the most appropriate end point for the EAM depends upon the nature of the available data to which a comparison can be made. For example, use of age at recruitment to the fishery might be the most appropriate end point for comparison to commercial or recreational harvest statistics. Alternatively, young-of-the-year might be an appropriate modeling end point where information on annual juvenile production might be available. Estimates of equivalent loss can also be converted to fractional loss estimates if estimates of total population size in the receiving water body are available. In addition, estimates of equivalent adult losses can be converted to total weight lost and then to equivalent economic value as part of a cost-benefit analysis.

### Application

The EAM has been one of the most widely used approaches for estimating the effect of cooling water withdrawal on the mortality of aquatic organisms at power plants throughout the nation. Reasons for this are two-fold. First, as previously discussed, results of the EAM can be used as input to a variety of environmental evaluations including impact assessment and cost-benefit analyses. Second, estimates of equivalent losses can be generated based on information produced from entrainment and impingement abundance monitoring studies without the need for often costly receiving

water body surveys. The EAM has been applied to both fish and invertebrate populations in ocean, estuarine, and freshwater environments.

The EAM model was used for impact assessment at the Seabrook Station and at the Pilgrim Station, both coastal power plants in New England (Saila et al. 1997), the Karn-Weadock Plants on Saginaw Bay, Lake Huron (EA 1979b), and a proposed Nuclear power plant at Jamesport, Long Island (Long Island Lighting Company [LILCO] 1975a). The EAM approach was also used in the Shoreham Unit 1 316 (b) Demonstration (LILCO 1975b) to assess intake effects on Long Island Sound populations of Atlantic menhaden (*Brevoortia tyrannus*) and scup (*Stenotomus chrysops*). Saila et al. (1997), using a risk-based approach, incorporated the use of “fuzzy mathematics” into the EAM model to account for non-statistical uncertainty in parameter estimation in order to calculate a potential range of equivalent losses for each target species. The EAM was used for both impact assessment and cost-benefit analysis at five Public Service Electrical Gas (PSE&G) power plants on tidal systems in northern New Jersey (EA 1988a, 1988b, 1988c, 1989a, 1989b) and for the Bayway Refinery 316(b) studies on the Arthur Kill (EA 1995). Delmarva Power and Light used this method as part of the environmental assessment of the proposed Dorchester Power Plant on the Nanticoke River in its 1993 application for a Certificate of Public Convenience and Necessity and for the Indian River Power Plant 316(b) Demonstration (Delmarva 1978). Florida Power Corporation used the EAM as part of post-operational environmental assessment for fish and invertebrates at the Anclote Unit No.1 (Florida Power 1977). The EAM was one of several quantitative models used for impact assessment of the Salem Generating Station on the Delaware estuary by both the utility (PSE&G 1984) and the regulatory agencies (Versar 1989a). Subsequently, the results of the EAM served as important input for the estimation of the appropriate number of acres of enhanced or restored wetlands to offset entrainment losses which was included as the basis for Special Conditions of the final New Jersey Discharge Elimination System (NJPDES) Permit for Salem (Section 2.5). The EAM has also been used on the Pacific coast for impact assessment purposes: at the Encina Power Plant, located on the Southern California Bight (EA 1997a); at the Diablo Canyon Power Plant, located along the central California coast (Tenera Environmental Services 1988); for the effects of entrainment and impingement on slough anchovy (*Anchoa delicatissima*) and topsmelt (*Atherinops affinis*) in San Diego Bay (San Diego Gas and Electric [SDG&E] 1980); and for entrainment effects at the Haynes Generating Station on the San Gabriel River estuary in Los Angeles (Intersea Research Corporation 1981).

### **2.2.2 Lost Reproductive Potential**

Reproductive potential refers to the total reproductive capacity of the population in any particular year. Most commonly, this reproductive potential is defined in terms of the total number of eggs produced by the population during the year or a reproductive cycle. However, for live-bearing or parthenogenic species, reproductive potential can



be defined in terms of other lifestages as well. The Lost Reproductive Potential (LRP) approach provides a measure of the annual reproductive potential of the population which has been lost as a result of power-plant-related losses of reproductively mature individuals from the spawning population (Table 2-2). For species in which the power-plant-related effects are limited to the pre-reproductive stages, then the lost reproductive potential is equal to the conditional mortality rate which can be estimated using other models (Section 2.3.3). However, for species in which power-plant-related effects include some reproductive lifestages (e.g., impingement of adults) then the LRP can provide a more reliable measure of population level effects than conditional mortality (Section 2.3.3) which focus on the relative effects from losses of pre-reproductive individuals. For a species, the individuals of which spawn multiple times over a number of years, loss of some older individuals whose future egg production would potentially contribute little to the continued maintenance of the population would have a smaller population-level effect than the loss of the same fraction of the population early in their reproductive years.

Dew (1981) was one of the first to discuss the significance of age-specific reproductive values for the assessment of power-plant-related effects on aquatic populations. Subsequently, the LRP approach was more fully developed using life table methods in PSE&G (1984). LRP is defined as the fraction of the total annual production of young which would have been produced by the population, but was lost as a result of power-plant-related effects. Mathematically, LRP is defined as:

$$N_{0w/o} = \sum_{i=1}^K ( N_{i-1} S_{iw/o} E_i Q_i R_i ) \quad (\text{eq. 2-3})$$

$$LRP = [ ( N_{0w/o} - N_{0w} ) / N_{0w/o} ] \times 100 \quad (\text{eq. 2-4})$$

$$N_{0w} = \sum_{i=1}^K ( N_{i-1} S_{iw} E_i Q_i R_i ) \quad (\text{eq. 2-5})$$

where:

$N_{0w/o}$  = Number of young produced without power plant effects

$N_{0w}$  = Number of young produced with power plant effects

$N_{i-1}$  = Number of individuals in lifestage (I)

$S_{iw/o}$  = Survival from lifestage (I-1) to lifestage (I) without power plant effects

- $S_{i_w}$  = Survival from lifestage (I-1) to lifestage (I) with power plant effects
- $E_i$  = Number of young produced by an individual female of lifestage (I)
- $Q_i$  = Proportion of lifestage (I) that are female
- $R_i$  = Proportion of females of lifestage (I) that are mature
- $K$  = Maximum number of lifestages (I) in the population

As with all of the fractional loss methods, estimates of LRP are calculated under the presumption that total mortality and mean production are constant within lifestage/age class and across the geographic range encompassed by the assessment.

While the LRP method was developed to assess potential population effects of direct losses of individuals through power-plant-related effects, this method could also be adapted for assessing potential sublethal effects of power plant operation such as effects on growth, reproduction, or maturity. Such an approach would be similar to that which has been used to extend the result of chronic toxicity tests on individuals to a population level basis (e.g., Daniels and Allan 1981; Allan and Daniels 1982; Walton et al. 1982). These methods use the intrinsic rate of increase ( $r$ ) as a population level effect end-point. The value of  $r$  is determined through life table methods, taking into account lifestage specific estimates of survival and reproduction similar to that used for the LRP method. While offering a means to extend the results of chronic toxicity testing to a population level, a subsequent investigation of this end-point across a large number of toxicity tests concluded that use of  $r$  does not add to the interpretation of toxic response over what can be determined from the fecundity and survival data alone and that this use of the measure is not a cost-effective addition to the evaluation of chronic toxicity (Barbour et al. 1989).

### **Application**

The LRP method was used as part of the assessment of cooling water withdrawal effects from the Salem Generating Station to aquatic populations in the Delaware estuary (PSE&G 1985, Versar 1989a). While this application was for a plant on an estuarine system, there is no reason that this approach could not be applied to other habitats as well.

The use of the intrinsic rate of population increase as an extension of chronic toxicity testing has been principally applied to the results of reproductive potential tests for invertebrates (e.g., *Ceriodaphnia*) conducted under laboratory conditions. Examples of pollutants considered include effluent from water treatment works and metal finishing facilities, acid-mine drainage, and pesticides (Barbour et al. 1989). While none of these

include power-plant-related pollutants, there is no reason that such pollutants (e.g., heat, metals, etc.) could not be considered as well.

As with each of the fractional loss models, the results of the LRP method do not provide a direct measure of the long-term effects of power-plant operation on the aquatic populations in the receiving water body. Such an assessment must also consider the magnitude of other sources of mortality on the population as well as the existence of compensatory processes (e.g., density dependent growth, predator-prey processes) within the specific populations of interest.

### 2.2.3 Production Forgone

Production is defined as the biomass produced by a population over a fixed period of time and includes both the net biomass increase in the population as well as the biomass lost as a result of mortality (Ricker 1946). This population production is available as food for other trophic levels or for harvest by man. Production forgone, then, refers to the total biomass which could have been produced by the population had the effects of power plant operations not occurred (i.e., population production which has been forgone as a result of power plant effects). Such a reduction in secondary production can result from power plant-related mortality or decreases in the growth rate of individuals. This forgone future production would have been available as food for higher trophic levels in the case of prey species, or for harvest of adults in the case of recreationally or commercially harvested species. This reduction in potential secondary production is estimated by the Production Foregone Model (PFM) and can be considerably larger than the accumulated actual biomass of any individuals lost because the PFM accounts for forgone future potential growth. Thus, the estimated difference in biomass production with and without power plant operations, or with alternative technologies can be used as a measure of power plant effects on the potential energy flow among trophic levels of the receiving water body ecosystem (see Section 2.5).

The first PFM (Table 2-3) was proposed by Rago (1984) and is based on the production model of Ricker (1975). In Ricker's model, production over a time interval includes not only the biomass accumulated by those individuals alive at the end of the interval, but also biomass produced by those individuals that died before the end of the time interval. Under Rago's (1984) discrete model, production forgone is defined as:

$$P_i = \frac{\overline{G_i N_i W_i} (\exp(G_i - Z_i) - 1)}{G_i - Z_i} \quad (\text{eq. 2-6})$$

$$P_T = \sum_{j=t_{\min}}^{t_{\max}} \sum_{i=j}^{t_{\max}} P_{ji} \quad (\text{eq. 2-7})$$

$$P_j = \sum_{i=j}^{t_{\max}} P_{ji} \quad (\text{eq. 2-8})$$

where:

$P_i$  = Production forgone for a specific age (I)

$P_j$  = Production forgone resulting from loss of individuals of age (j)

$P_T$  = Total production forgone resulting from loss of all individuals

$G_i$  = Instantaneous growth rate for individuals of age (I)

$Z_i$  = Instantaneous mortality rate for individuals of age (I)

$N_i$  = Number of individuals of age (I) lost as a result of power plant operation

$W_i$  = Average weight of individuals of age (I)

$t_{\min}$  = Youngest age groups considered (typically eggs)

$t_{\max}$  = Oldest age group

In practice, estimates of  $N_i$  are typically based on the results of site-specific studies (e.g., entrainment and impingement monitoring). Estimates of  $G_i$  and  $W_i$  are typically based on a species-specific growth curve, while estimates of  $Z_i$  are typically based on species-specific survival curves. Estimates of  $G_i$ ,  $W_i$ , and  $Z_i$  can be based on information available from the scientific literature or on the results of site-specific studies.

Jensen et al. (1988) subsequently proposed two alternatives to the Rago model for estimation of production forgone. First, Jensen et al. (1988) proposed use of a continuous-time “analytical” model based on the Beverton-Holt (1957) analytical yield equation. Mathematically, this model defines production forgone resulting from the loss of any lifestage as:

$$P_j = \sum_{i=j}^I \int N_i \frac{\partial W_i}{\partial x} \partial x \quad (\text{eq. 2-9})$$

$$P_T = \sum_{j=1}^J P_j \tag{eq. 2-10}$$

where:

$P_j$  = Production forgone resulting from loss of individuals of age (j)

$P_T$  = Total production forgone resulting from loss of all individuals

$N_i$  = Number of individuals of age (I) lost as a result of power plant operation

$W_i$  = Average weight of individuals of age (I)

I = Maximum of number of ages

J = Maximum of number of ages affected by power plant operations

The use of the continuous time analytical model with more than a few ages can result in exceedingly complex analytical equations (as illustrated in Jensen et al. [1988]); however, these authors suggest that it improves over the Rago discrete model through its use of the well established and investigated Beverton-Holt yield model and fewer requisite input parameters.

Jensen et al.'s (1988) second alternative approach for estimation of production forgone is through the use of an indirect method which calculates production forgone as the difference between the total population production estimated without the power plant operating and a total population production estimated with the power plant in operation. The primary advantage of this method is that production forgone can be expressed as a fraction of the total production in the receiving water body. This indirect method follows the "analytical" method described above but requires several additional parameters including the number of eggs per unit of female biomass, the proportion of females in the mature stock, proportion of eggs that hatch, annual number of recruits, and the annual cooling water flow at the power plant. However, the authors found that estimates for all of these input parameters were not available for the example used at the time. In fact, it is unlikely that all of this information will be available for many populations of interest. For their example, Jensen et al. adjusted annual recruitment such that the results of this indirect model approximated the results of the two direct methods (Rago and "Analytical"). Using this "tuned" model, annual production forgone in this example amounted to approximately 6 percent of the total annual production of gizzard shad in western Lake Erie (Jensen et al. 1988).

## **Application**

The PFM can be a useful tool to aid in the assessment of potential adverse environmental impact related to power plant operations, particularly for species which are important to the food chain as prey/forage for higher trophic levels. In these situations, what is important to the energetics of the ecosystem is the total amount of biomass generated by the population at any set age which is available for consumption by predators, not necessarily the number of individuals surviving to that age. Consequently, the results of the PFM can provide a much more pertinent measure of loss in the impact assessment process than the Equivalent Adult Model (Section 2.2.1); in some cases, the EAM may be an intermediate step in the process of estimating biomass lost.

A form of the Production Forgone Model was used as part of the impact assessment process for the Salem Generating Station located on the Delaware estuary (PSE&G 1984, Versar 1989a). The Biomass Lost Model (BLM), similar to Rago's (1984) PFM, was used as part of the impact assessment for Consumers Powers Kern Weadock Plants on Saginaw Bay, Lake Huron (EA 1979a), for five generating stations located in tidal freshwater and marine waters of northern New Jersey (EA 1988a, 1988b, 1988c, 1989a, 1989b), and the Bayway Refinery cooling water intake on the Arthur Kill in New Jersey (EA1995). The primary difference between BLM and PFM is that the BLM accounts for the actual loss of existing biomass through entrainment and impingement in addition to future production forgone.

To date, the PFM has been primarily used to assess population level consequences of entrainment and impingement loss attributable to cooling water intake structures. However, this approach could also be used to estimate the production forgone as a result of any increased mortality associated with any aspect of power plant operation. Further, with minor modification, this model could be used to assess the consequences to population production from changes in individual growth rates such as might result from exposure to power plant discharges, including heat or toxic chemicals.

## **2.3 Fractional Losses**

Fractional loss methods estimate power-plant-related effects in terms of a fraction of standing stock, population, or community in the source/receiving waterbody. Fractional loss estimates for populations are most commonly expressed in terms of exploitation rates or conditional mortality rates as described by Ricker (1975). Most of these models are variations on the same basic theme, with varying degrees of complexity in an attempt to more accurately reflect natural conditions. The types of fractional loss analyses are presented below in order of increasing complexity.

### 2.3.1 Habitat Ratio Approach

Habitat ratio is the simplest of the fractional loss approaches; the potential effects of power plant operation are expressed in terms of a fraction of the total available habitat (e.g., spawning habitat, nursery habitat) affected. This fraction may be based on water volume (Section 2.3.1.1) or habitat area (Section 2.3.1.2) and has been used to assess the proportional changes in aquatic populations related to cooling water intake and discharge operations.

#### 2.3.1.1 Water Volume Ratio

This technique compares absolute loss estimates (e.g., numbers of a species lost as a result of entrainment or impingement based on cooling water volumes) on a volume to volume basis with the total water available within the source water aquatic system (Portner and Kohlenstein 1979, King 1978) (Table 2-4). In its simplest form, the method estimates the potential fractional losses due to entrainment based on the ratio of cooling water flow to river flow assuming uniform organism densities across the source waterbody in the vicinity of the plant and in the cooling water system. In more typical applications, the product of organism density (e.g., number of a species/lifestage in a standardized volume of water) in the cooling water system times the cooling water volume is divided by the product of source water organism density times the source water flow volume:

$$\text{Percent Entrained} = \frac{N_c \times F_c}{N_s \times F_s} \times 100 \quad (\text{eq. 2-11})$$

where:

$N_c$  = organism density in the cooling system

$F_c$  = cooling water flow

$N_s$  = source water density

$F_s$  = source water flow

$N_c$  and  $N_s$  are determined from biological sampling programs conducted in the cooling system and in the source waterbody. As part of a preliminary screening assessment before biological data are available, an assumption that the two densities are the same simplifies the equation to a ratio of the cooling water flow to the source water flow.

When biological sampling programs to estimate organism densities in the source waterbody and cooling water systems are developed for this type of analysis,

consideration needs to be given to maximize the comparability of factors influencing sampling efficiency in the two locations. Depending on the comparability of sampling gear, methods, and conditions, and the regulatory circumstances, at some sites it may be necessary to evaluate and correct for sampling bias; that is, adjusting for differences between estimated cooling water system and source waterbody densities introduced as a result of differences in sampling procedures and parameters between locations.

A modification of this method adjusts the fractional loss estimates for the proportion of live and dead organisms in the source water cross-section (Marcy 1974, Gammon 1977, King 1978, Rogers 1978, Carter 1978) in order to account for background mortality to organisms in the waterbody. In this variation, the N values become the density of live organisms at the cooling water intake and in the source water.

A significant shortcoming of this approach is that estimates of average organism density in the cooling water system and river cross-sections are biased by non-uniform and patchy distributions, both spatially (vertical and horizontal) and temporally. In addition, in this basic form the method can underestimate the fractional losses in tidal rivers where organisms may be subjected to transport multiple times past a cooling water intake (Marcy 1974); more complex hydrodynamic models have been developed and calibrated to site-specific condition to account for tidal mixing factors (Section 2.3.4).

### **Application**

The Water Volume Ratio method has been applied and documented at a number of riverine power plants including both tidal (Hudson River Policy Committee [HRPC] 1968, Marcy 1974, Portner and Kohlenstein 1979 ) and non-tidal sites (Gammon 1977, King 1978, Carter 1978, Rogers 1978). Incorporation of tidal effects can be difficult as demonstrated in early studies on the Hudson River where tidal reversal was not adequately factored into the analysis (HRPC 1968).

The Water Ratio method has been applied primarily to estimate the relative magnitude of cooling system entrainment of planktonic and semi-planktonic taxa and lifestages. The method makes several simplifying assumptions which can lead to under- or over-estimates of fractional losses. With minimal field sampling, the method can serve as a screening tool to broadly categorize, on a semi-quantitative level, the relative magnitude of potential entrainment effects. On the other hand, with more extensive field sampling and studies to quantify potential biases related to differential collection gear efficiency and non-homogeneous distribution of organisms, more complex modeling of the in-plant to river ratios can be used to estimate potential entrainment effects. The method has been applied to microzooplankton, macrozooplankton drift organisms, and early planktonic lifestages of fish.



The Water Volume Ratio method can be taken to another level of complexity in an attempt to better simulate actual conditions by coupling of biological data with more complex hydrodynamic modeling (Section 2.3.4; e.g., Polgar et al.1976). This ratio method has been conceptually incorporated into several hydrodynamic transport models as the “withdrawal ratio” (W-factor), which is used to account for differential abundance between the cooling water intake and the nearfield source water (Englert and Boreman 1988).

One of the primary shortcomings of the various ratio methods is that sampling gear and sampling conditions are seldom identical for the source waterbody and the cooling water system, which introduces potential problems of sample comparability between sampling locations. At Indian Point Generating Station intensive studies were conducted to quantify this differential with a relative probability of capture (RPC) study involving concurrent sampling at multiple depths and locations in the Hudson River and at the Station discharge (Coastal Environmental Services 1991). Ratio estimates were calculated to quantify the differences between the River and cooling system and to evaluate sources of differences including diel distribution, length and species-related differences, tidal effects, and sampling effects such as organism extrusion and gear avoidance.

#### 2.3.1.2 Affected Area/Volume Ratio

The Affected Area/Volume Ratio method (Table 2-5) addresses potential discharge plume impact in terms of relative area of aquatic habitat within the plume from which selected taxa may be excluded, or within which they may be adversely affected as a result of behavioral or physiological responses to physical or chemical characteristics of the plume. Representative Important Species (RIS in the context of §316 (a) Demonstrations–U.S. EPA 1974, 1977) are typically selected in consultation with the involved regulatory agencies based on their local abundance, sensitivity to the discharge parameter of concern, representativeness of a trophic level or guild, importance in the aquatic food chain, importance as the target of a commercial or recreational fishery, or designation as a rare, threatened, or endangered species. The number of taxa selected often depends on the complexity of the aquatic ecosystem in the vicinity of the discharge plume. Dose-response information is gathered from the scientific literature (Coutant 1972, Brungs and Jones 1977, EA 1978a, 1978b, Eaton et al. 1995) and/or from site-specific laboratory studies (PSE&G 1974, Texas Instruments 1976, EA 1978a, Jersey Central Power and Light [JCP&L] 1978, Pacific Gas and Electric [PG&E] 1988) to quantify the physiological and/or behavioral response of each RIS to the stressor (e.g., temperature, chemical contaminant). The information used may be in the form of standardized aquatic toxicity test endpoints (e.g., 50 percent acute effect [LC50], chronic value [ChV], no observed effect concentration [NOEC], lowest observed effect concentration [LOEC]), inhibition concentration, or other quantitative response indices (e.g., optimum temperature for growth, avoidance value, preference range).

The distribution and dilution rate of the discharge plume are characterized through a mapping study of the discharge plume within the receiving water; this may entail dye dilution studies, direct measurement of selected physical or chemical characteristics of the plume which are of concern (e.g., temperature, residual chlorine), or aerial infrared photography. Three-dimensional data or modeling are necessary in order to define areas of bottom habitat contacted by the plume and receiving waterbody cross-section affected by the discharge plume. Discharge plume isopleth maps are plotted for the power plant operating and environmental conditions existing at the time of the survey; isopleths may represent areas of constant chemical concentration or dilution, absolute temperature isotherms, or temperature differential from ambient (i.e., delta T). Isopleth intervals should be selected for consistency with surface water quality criteria and the range of applicable organism dose-response data. Additional mathematical modeling of the plume may be required to characterize other critical conditions (e.g., maximum cooling water flow, full generating capacity, critical receiving water flows or mixing conditions, tides, seasons) not represented during field surveys.

The plume isopleths are plotted on a habitat map of the receiving waterbody. The level of detail in habitat will depend on the complexity and variety of habitat in the aquatic system, the life history requirements of RIS in the area, the size and distribution of the discharge plume, and the amount of distributional and life history information which exists for a particular site. In heavily industrialized areas it may be as simple as identifying shoals and maintained shipping channels; other locations may require more detailed mapping of such features as unique or critical spawning or nursery habitat, aquatic macrophyte beds, reefs, shellfish beds, and migratory routes. Mapping in more complex habitats may involve direct observation from the water surface, diver surveys, remote sensing technology, or video recording with the use of remote operated vehicles (ROVs) depending on depth and water clarity.

Assessment of the estimated magnitude of discharge plume effects is accomplished by comparison of the area/volume of the plume in which adverse environmental effects are predicted against the area/volume of similar habitat available within the project assessment region agreed upon between the permittee and regulators. The first step is to determine the area/volume of the discharge plume where adverse effects are predicted; that is, where concentrations, temperatures, or velocities exceed threshold measurement endpoint values identified during the literature review/laboratory studies. The assessment may involve evaluation of multiple endpoints for each RIS to determine the most realistic, sensitive measure of discharge effects; for example, reduced short-term or long-term survival, reduced growth, reduced spawning success, behavioral avoidance, blockage of migratory pathways or critical habitat, or increases in parasitism or nuisance organisms growth and abundance. Seasonally, at many locations, some of these measures may include enhancement of growth or attraction to warmer plume waters. The area affected may be calculated as a surface area, the area of a receiving water cross-section, area of bottom, or volume within a specific isopleth.

Under appropriate conditions, hydroacoustic surveys or ROV video recording may be useful for documenting or verifying predicted areas of attraction or avoidance.

The area/volume adversely affected is then compared as a ratio or percent of the specified habitat area/volume available to the RIS population. This step requires the judgment of trained fisheries scientists and ecologists to select the regional scale over which to measure available habitat; this scale is likely to vary among RIS (Section 5.2 in LMS 1979b). For example, critical spawning habitat for an endangered species may be very limited and readily defined, whereas defining the basis for areal comparison for an ubiquitous species such as the bay anchovy (*Anchoa mitchilli*) will be more difficult. Ultimately this may require selection of a somewhat arbitrary geographic area based on some realistic estimate of the range of a fish stock, or a portion of the population with the potential to be influenced by the discharge plume during the period for which the assessment is made. Such arbitrary boundaries inherently make the conservative assumption that there is no immigration/emigration of organisms across that boundary.

### **Application**

The Affected Area/Volume Ratio has been used extensively in predictive §316 (a) Demonstrations at power plants and other non-contact cooling water discharges (Orange and Rockland Utilities, Inc. [ORU] 1978 ; EA 1979a, 1979 b, 1997; PSE&G 1988a, 1988b, 1989a, 1989b, 1994). The approach has not been widely applied to chemical components of power plant discharges, although similar methods have been applied to other industrial and wastewater discharges. Unlike the Water Volume Ratio method (Section 2.3.1.1) which predicts the proportion of the population of a taxa passing the power plant which will be entrained, this method predicts the proportion of the habitat in which adverse effects may occur or which will have limited availability to a taxa. The Affected Area/Volume Ratio method does not directly address the magnitude of the population of a taxa which is affected by the discharge. Extrapolating this method to populations would require an assumption that the organisms are uniformly distributed over the extent of their geographic range within the area and period of the assessment; such an assumption can rarely be supported. The complexity of the method, expertise required, and associated cost will vary on a site-specific basis, depending on the plant operating characteristics, receiving water characteristics, and ecosystem complexity (Coutant 1992). For example, on a relatively simple non-tidal freshwater system, plume isopleth maps generated by visual interpolation from field data may be adequate for generating discharge plume isopleth maps and area calculations. However, more complex estuarine or coastal sites, where tides, density, or upwelling conditions influence mixing and plume movement, generally require more extensive field plume surveys, extensive background water temperature and current monitoring, and three-dimensional hydrodynamic modeling.

### **2.3.2 Exploitation Rate/Fractional Cropping Rate**

The exploitation rate method (Table 2-6) estimates the fraction of the initial population size that is lost during a specified interval as a result of power-plant-related mortality; exploitation rates have been used to assess organism losses due to entrainment (EA 1978c) and impingement (Intersea Research Corp 1981; Parker et al. 1989). Typically, these estimates are based on a comparison of an estimate of the number of individuals lost, to an estimate of the standing crop that was expected to occur within the area of concern at the beginning of the period of loss (Barnthouse et al. 1979; PSE&G 1984). If an accurate method were available to estimate numbers of organisms lost due to thermal or chemical exposure in the discharge plume, this method also would have the potential to be used to evaluate the relative population effects of losses associated with plume entrainment.

Exploitation rates are one of several related mortality rate calculations which have been used to evaluate a variety of mortality sources (e.g., commercial and recreational fishing mortality, and power-plant-related mortality) and their effect of losses of individuals to the overall population (Barnthouse et al. 1979; LMS 1979b; Ricker 1975). Actual or total mortality rates are a measure of the total reduction "observed" in the population or cohort during a given period of time with no consideration given to the sources of mortality. Similarly, the entrainment exploitation rate is a measure of the fraction of the population lost during a period as a result of the actual "observed" entrainment mortality. Distinct exploitation rates can be calculated for each identified source of mortality of concern.

In most aquatic environments there are numerous potential sources of mortality which organisms must survive during a given time interval or lifestage, or in order to reach maturity and spawn. These sources may be "natural," such as predation, cannibalism, disease, starvation, floods and drought, or may be associated with human activities, including power plant effects, as well as other point and non-point source discharges and fishing. A fish larva that dies during entrainment cannot die later as a result of predation; similarly, a larva which dies due to predation cannot later be entrained. Thus, in order to look at the incremental effect of a single source of mortality (for example, entrainment) or to put each source into perspective, a conditional mortality rate (CMR--Section 2.3.3) (LMS 1979b, Barnthouse et al. 1979) can be calculated, which is a measure of the mortality from one source, if there were no other sources of mortality operating.

Exploitation rates are relatively easy and the simplest calculation with minimal data requirements; that is, there are no adjustments for other mortality and no requirement for hydrodynamic data or information on the spatial distribution and migratory patterns of the population. The only data required are estimates of the power-plant-related organism losses, which are relatively easy to collect, and an estimate of overall population abundance in the area of the assessment. The methods for data collection

and estimation of population abundance range widely in accuracy and precision, as well as associated effort and cost. The level selected will depend on the study objectives and regulatory pressure; however, generally the predictive methods described in subsequent sections of this document progressively increase in complexity and will require an associated increase in the quantity and quality of data required to evaluate population level effects.

The exploitation rate will typically underestimate the effect of power plant losses because it does not take into account the competitive interaction between power plant induced mortality and all other source of mortality which is accomplished using CMR methods. As a result of this interaction among competing sources of mortality, the rate calculated for exploitation (u) is less than that of the CMR except when natural mortality does not occur (which is highly unlikely).

### Application

#### Exploitation rate method

As described by Barnthouse et al. (1979), calculation of the impingement or entrainment exploitation rate (u) is equivalent to Ricker's (1975) rate of exploitation of a fish stock:

$$u = \frac{E}{N_0} \tag{eq. 2-12}$$

or

$$u = \frac{I}{N_0} \tag{eq. 2-13}$$

where:

I = total number of a taxa/lifestage impinged during a time interval

E = total number of a taxa/lifestage entrained during a time interval

N<sub>0</sub> = size of the initial population of the taxa/lifestage in the source water

Exploitation rates are often used in fisheries applications, but are particularly useful for evaluation of entrainment effects on invertebrate populations (e.g., gammarids and mysids) which complete several overlapping generations within a single season. As a result of this reproductive strategy, separate cohorts cannot readily be distinguished as for many fish species which spawn over relatively short periods of the year, producing

distinct year classes or cohorts. This merging of multiple generations during a single year typical of many invertebrates populations eliminates many more complex impact assessment techniques, which follow distinct cohorts or year classes, from consideration (PSE&G 1984, Versar 1989a).

### Fractional cropping rates variation

At any given time a power plant may entrain or impinge a range of ages or lifestages of organisms in a population. Cropping rates typically vary over a season in conjunction with this change in age distribution. Simple exploitation rates do not account for the potential differential in population effects which will occur as a result of entraining different lifestage at different rates. That is, for populations which experience high rates of early natural mortality that decrease with age, the loss of 1,000 eggs may have relatively less of an effect on the population than the loss of 1,000 organisms at successively older lifestages. Fractional cropping rates have been applied to assessment of entrainment effects (LILCO 1975a, Delmarva Power 1978, Portner and Kohlenstein 1979, Delmarva Power 1982) in order to address this issue. Originally developed for Delmarva Power and Light's Summit Station, this method is referred to as a "ratio model" and a full copy of the program is provided as an appendix to the entrainment/impingement assessment for the proposed Unit No. 9 at Delmarva's Vienna Station on the Nanticoke River (Portner and Kohlenstein 1979). Similar to the equivalent adult method (Section 2.2.1), fractional cropping rates can be used to express power plant losses across several lifestages on the basis of lost production at a specific lifestage. For example, losses of eggs, larvae, and post larvae of a species that is vulnerable to entrainment for a period of 60 days can be expressed as the fractional cropping by the power plant of total egg production in the source waterbody (Portner and Kohlenstein 1979). This variation of the exploitation rate method calculates fractional cropping for each vulnerable age class/lifestage (e.g., eggs, yolk-sac, and post yolk-sac larvae) for each day that the age class/lifestage is vulnerable. In this case the calculation is based on the ratio of estimated numbers of each age class/lifestage entrained to numbers of that age class/lifestage in the source waterbody:

$$f_{ls} = \frac{y_i V_i}{\sum y_j V_j} \quad (\text{eq. 2-14})$$

where,

$f_{ls}$  = fraction of the lifestage in the water body entrained during a given day

$y_i$  = density of lifestage in cooling system on given day

$V_i$  = volume entrained on given day

$y_j$  = density of lifestage in river zone j on given day

$V_j$  = volume of river zone j

If the same gear are used for river and in-plant ichthyoplankton sampling, then potential gear bias or inefficiencies cancel out between the numerator and denominator of this formula. One uncertainty is the volume to use for each river zone, particularly the uppermost and lowermost geographic boundary zones when lifestage densities in these zones are not zero. If there is exchange across the boundary, significant numbers of organisms outside of the sampling region of the river would cause the daily entrainment fraction to be overestimated. Daily cropping estimates of each lifestage are then accumulated over the period of vulnerability to entrainment taking into account the duration of each age class/lifestage. Portner and Kohlenstein (1979) used this model to evaluate several alternative locations for the proposed cooling water intake and alternative intake screen designs.

**Before-after data methods**

Parker et al. (1989) developed a variation of the exploitation rate technique for the Marine Review Committee’s evaluation of changes in impingable fish abundance in the vicinity of the San Onofre Nuclear Generating Station on the California Coast. This method utilized data from a Before-After Control Impact (BACI--see Section 3.4) sampling program to estimate depressions/increases in fish standing stock abundance of two coastal marine species in the nearfield vicinity (“Impact area”) of the San Onofre Station which were compared to estimated intake losses. The ratio of intake losses to an index of population change between before and after sampling programs was used to evaluate whether population changes could be accounted for on the basis of intake losses alone. This application assumed that the population in the larger coastal area was at equilibrium in making the following calculation:

$$c = s / \left( \frac{N_p}{N_o} - 1 \right) \tag{eq. 2-15}$$

where:

c = per capita rate of organisms leaving the area

s = per capita death rate in the area due to the intake losses

$N_p$  = the population size in the area unaffected by the plant

$N_o$  = the population size in the area affected by the plant

The mean residence time ( $1/c$ ) provides a measure of the rate at which fish would need to leave the impact area in conjunction with the estimated through plant loss rate, in order for a species to exhibit an observed regional population depression. The higher the calculated value of  $1/c$ , the less likely that through plant losses alone account would account for the depression (Parker et al. 1989); that is, other factors may be affecting local population depressions including, but not limited to plume effects, avoidance, and other habitat or food chain changes.

### **Mark-recapture methods**

Another commonly used method to estimate impingement exploitation rates is through the use of mark-recapture techniques (LMS 1980a; p. 1-271). With this procedure, the impingement exploitation rate ( $u$ ) can be calculated as the ratio of the number of recaptures ( $R$ ) collected in impingement monitoring samples to the number of marked fish in the population ( $M$ ):

$$u = \frac{R}{M} \quad (\text{eq. 2-16})$$

Although it is not necessary to calculate the population standing crop with this procedure, the mark-recapture program requires the direction of an experienced fisheries scientist to assure that it is well designed and satisfies the assumptions of mark-recapture experimental design for open or closed populations, as appropriate (LMS 1980a; pp. 1-40 and 1-66). When all impinged organisms are not collected and processed by the impingement monitoring program,  $R$  must be proportionately adjusted to account for the fraction of impingement not sampled.

### **2.3.3 Conditional Mortality Rates**

Conditional mortality rates (CMRs) are an estimate of the fractional reduction of a source population as a result of cropping (removal of live organisms from the population) by a power plant (usually by way of entrainment or impingement). In contrast to exploitation rates (Section 2.3.2), CMRs provide a standardized estimate of the relative reduction due to power plant operation in the absence of all other sources of mortality. This requires a significant increase in the complexity of the model structure used to make the CMR estimate and the data required as input to the model. Three types of models have been widely applied for estimation of CMRs for power-plant-related entrainment and impingement losses of organisms: abundance-weighted affected area (volume) ratio; empirical transport model; and empirical impingement model.



### 2.3.3.1 Abundance-Weighted Affected Area/Volume Ratio

This group of methods calculate a measure of fractional loss resulting from power-plant-related effects by taking into account the potential non-uniform distribution patterns of affected lifestages across available habitat (Table 2-7). In this regard, these models reflect an intermediate step between the conceptually simple area/volume ratios (Section 2.3.1) and the more fully developed distribution-based models, such as the ETM (Section 2.3.3.2). Variations of this approach have been embodied in the Spawning and Nursery Area of Consequence (SNAC) Model described by Polgar et al. (1979) and for estimation of relative adult-equivalent loss by Parker and DeMartini (1988).

The SNAC model was developed to estimate fractional losses as a result of entrainment mortality in the cooling system and discharge plume of operating power plants located on estuaries. This model uses hydrographic and bathymetric information of the receiving water body, estimates of cooling water recirculation, and biological information on spatial distribution patterns and lifestage durations of the target species to estimate fractional losses. Estimation of fractional loss using this model is conducted in three steps. First, the SNAC model calculates the probabilities of condenser and plume entrainment as follows:

$$P_E = (1 - P_R) \frac{Q_P}{Q_T} \quad (\text{eq. 2-17})$$

$$P_P = \frac{A_C}{A_T} \quad (\text{eq. 2-18})$$

where:

$P_E$  = probability of condenser entrainment

$Q_T$  =  $|Q_U| + |Q_L|$ , sum of upper and lower layer water transports

$Q_P$  = cooling water flow rate

$P_R$  = probability of cooling water recirculation

$P_P$  = probability of plume entrainment

$A_C$  = cross-sectional area of the excess temperature isotherm which induces mortality

$A_T$  = total cross-sectional area where the target species resides

Next, these probabilities are converted to fractional loss estimates for each lifestage (j) as follows:

$$P_{ij} = P_E \frac{Q_T}{Q_k} Q_k L_{ij} \frac{T_{ijk} D_{ijL} M_{ijE}}{D_{ijR} SA_{ij} z N_{ij}} \quad (\text{eq. 2-19})$$

$$W_{ij} = P_P \frac{A_T}{A_U} Q_d L_{ij} \frac{T_{ijk} D_{ijL} M_{ijP}}{D_{ijR} SA_{ij} z N_{ij}} \quad (\text{eq. 2-20})$$

where:

- $Q_k$  = discharge in water layer (k) where the cooling water is withdrawn
- $L_{ij}$  = length of time stage (j) of species (i) occurs in water column
- $T_{ijk}$  = proportion of each 24-hour period lifestage (j) of species (i) spends in water layer (k)
- $D_{ijL}$  = mean density of lifestage (j) of species (i) in local region during interval
- $D_{ijR}$  = mean regional density of lifestage (j) of species (i)
- $SA_{ij}$  = horizontal surface area of region inhabited by lifestage (j) of species (i)
- $M_{ijE}$  = entrainment mortality rate of lifestage (j) of species (i)
- $z$  = mean depth of estuary associated with  $SA_{ij}$
- $N_{ij}$  = number of generations of lifestage (j) of species (i) during period of susceptibility
- $Q_d$  = transport rate in water layer (d) in which plant discharge is located
- $A_U$  = cross-sectional area of water layer(s) in which plant discharge is located
- $M_{ijP}$  = plume exposure mortality rate of lifestage (j) of species (i)

Finally, annual estimates of fractional loss ( $P_i$ ) for species (i) integrating all affected lifestages are calculated using the values calculated above as follows:

$$P_i = 1 - \prod_{j=1}^J [1 - (P_{ij} + W_{ij})] \quad (\text{eq. 2-21})$$

where:

J = number of potentially affected lifestages

Use of this model requires site-specific information on the bathymetric and hydrologic conditions in the vicinity of the plant. In addition, site-specific studies are required to determine the density of each lifestage of the target species relative to that found throughout the geographic range of this species. Information on lifestage durations, vertical migratory patterns, and entrainment mortality could be based on site-specific studies or the general scientific literature.

As can be seen, this model was developed for use in vertically stratified systems, such as might be found in mesohaline sections of estuaries. Key assumptions of this model are that entrainment is proportional to cooling water withdrawal rates and that conditions, including flows, cooling water withdrawals and discharges, excess temperature patterns, recirculation, and distributional patterns all remain constant throughout the period of vulnerability of each lifestage.

A simplified version of this approach was used for estimation of fractional loss due to entrainment at the San Onofre Nuclear Generating Station (SONGS) which draws cooling water from the Southern California Bight through a submerged offshore intake. This model presumes homogeneous vertical mixing throughout the water column but a heterogeneous distribution from inshore to offshore areas. Water, and presumably entrainable organisms, are transported to the vicinity of SONGS via wind-induced longshore currents. The distribution of each lifestage (j) of species (i) was described based on sampling of five cross-shelf transects located parallel to the coast line. Using this information, daily fractional loss of lifestage (j) of species (i) due to entrainment was defined as follows:

$$P_{ij} = \frac{D_{ijPP} V_{PP}}{D_{ijR} V_R} \quad (\text{eq. 2-22})$$

where:

$D_{ijPP}$  = mean density of lifestage (j) of species (i) in transects from which the cooling water is withdrawn

$V_{PP}$  = volume of water in transects from which the cooling water is withdrawn

$D_{ijR}$  = mean density of lifestage (j) of species (i) across all transects

$V_R$  = volume of water across all transects

Using this daily fractional loss estimate for lifestage (j), annual fractional loss ( $P_i$ ) for species (i) is defined as:

$$P_i = 1 - e^{-\sum_{j=1}^J (P_{ij} t_{ij})} \quad (\text{eq. 2-23})$$

where:

$t_{ij}$  = duration of lifestage (j) of species (i)

Assumptions and input data requirements for this model, which assumes homogeneous vertical distribution, are identical to that previously described for the SNAC model.

### Application

The SNAC model has been used as a screening tool for assessing the potential for adverse environmental impact at Morgantown and C.P. Crane Steam Electric Stations, both located on tidal tributaries to Chesapeake Bay (Polgar et al. 1979, Martin Marietta Corp 1983). At these locations, the SNAC model was used for four freshwater fish species, three anadromous fish species, four estuarine fish species and four marine fish species which utilize areas near these plants as spawning/nursery habitat. In addition, three species of estuarine clams, blue crabs, and American oysters were also evaluated using this model.

Versar (1989c) used the SNAC model to evaluate entrainment/impingement effects from cooling water withdrawals for the Oyster Creek Nuclear Generating Station. The model was used to estimate losses for two marine fish and four estuarine invertebrate species which utilize Barnegat Bay as spawning and nursery habitat. Population losses estimated by SNAC were used to estimate economic value relative to commercial and recreational fisheries and percent reduction in ecosystem production associated with these losses.

Southern California Edison (SCE 1982) and MacCall et al. (1983) described a relative cohort reduction model which was used for a regional multi-plant assessment of their power plants in the coastal waters of Southern California Bight. These studies examined power-plant-related effects on 15 marine inshore and pelagic fish species. The relative adult-equivalent loss model used to estimate fractional losses from entrainment at SONGS (Parker and DiMartini 1988) was a further adaptation of this approach. For this assessment, the model was applied to a total of nine taxa, all of

which are common inhabitants of nearshore coastal waters of the Southern California Bight.

### 2.3.3.2 Empirical Transport Model

The Empirical Transport Model (ETM) is a comprehensive model developed for estimation of conditional mortality rates (CMR) (Table 2-8). This model is termed “Empirical” in that it uses empirically-derived organism distribution and movement characteristics as model input. These inputs serve to define the relative vulnerability of each lifestage to cooling water withdrawal effects during each model time step. The ETM was first described by Boreman et al. (1978) in a U.S. Fish and Wildlife Publication and later in the peer review literature (Boreman et al. 1981). Since that time the ETM has been widely adopted for estimation of the conditional mortality rate resulting from entrainment at cooling water intakes.

To effectively model the complex spatial and temporal dynamics of each species’ vulnerability to entrainment, the ETM breaks the annual production of young for a particular species into individual cohorts. Each cohort represents the spawning production within the entire receiving waterbody during each model time step. While the model time step can be of any duration, a weekly interval has been most commonly used. A weekly interval has been a reasonable time step in terms of spawning duration of many of the target species which have been examined and for computational accounting and computer capabilities; furthermore, a week is a convenient duration upon which many biological field sampling programs have been based. Computational time steps can also be constructed to account for variation in the natural flow regime of the waterbody. Each cohort remains potentially vulnerable to entrainment for a duration defined as the entrainment interval, after which, owing to growth and/or movement out of the area, entrainment of that cohort ceases. The entire time period during which the species is potentially vulnerable to entrainment is defined as the entrainment period which is approximately equal to the composite duration of spawning plus the entrainment intervals for all cohorts. In addition to these temporally defined terms, the ETM divides the receiving water body into discrete regions to account for spatial variability in abundance and to allow for the estimation of conditional mortality for more than one power plant operating on a specific water body or other major sources of mortality on the water body.

The ETM begins by defining an instantaneous entrainment mortality rate ( $E_{s+j,k,l}$ ) of lifestage (l) for model time step (s+j) from region (k). Each model time step is defined by the spawning time step for that cohort (s) plus the subsequent age (j) of that cohort. In mathematical terms, this instantaneous mortality rate is defined as follows:

$$E_{s+j,k,l} = \frac{V e_{s+j,k} \times f_{s+j,k,l} \times W_{s+j,k,l}}{V_k} \quad (\text{eq. 2-24})$$

where:

$E_{s+j,k,l}$  = Instantaneous entrainment mortality rate for lifestage (l) in time step (s+j) from region (k)

$Ve_{s+j,k}$  = Volume of water entrained during time step (s+j) from region (k)

$f_{s+j,k,l}$  = Through-plant mortality of lifestage (l) in time step (s+j) entrained from region (k)

$W_{s+j,k,l}$  = Ratio of the average power plant intake concentration of lifestage (l) to average concentration in region (k) during time step (s+j)

$V_k$  = Volume of region (k)

This instantaneous mortality rate (E) is equal to the instantaneous rate of removal of organisms from region (k) as a result of entrainment mortality.

For calculation of conditional mortality rates using the ETM, instantaneous entrainment mortality rates are calculated for each lifestage of each cohort in each region during each model time step. The resulting array of instantaneous mortality rates are then combined into an overall annual conditional mortality rate for each species ( $CMR_c$ ) using the following formula:

$$CMR_c = 1 - \sum_{s=1}^S R_s \left\{ \prod_{j=0}^J \left[ \prod_{l=1}^L \left( \sum_{k=1}^K D_{s+j,k,l} e^{-E_{s+j,k,l} t C_{j,l}} \right) \right] \right\} \quad (\text{eq. 2-25})$$

where:

$E_{s+j,k,l}$  = Instantaneous entrainment mortality rate for lifestage (l) in time step (s+j) from region (k)

$R_s$  = Relative temporal spawning index for each spawning interval(s)

$D_{s+j,k,l}$  = Proportion of total abundance lifestage (l) in model time step (s+j) within region (k)

$C_{j,l}$  = Fraction of cohort in lifestage (l) during age (j)

t = Length of model time step

- e = Base of natural logarithms (2.71828...)
- S = Total number of spawning intervals (s) in units of the model time step
- J = Total number of ages (j) in units of the model time step
- L = Total number of lifestages (l)
- K = Total number of regions (k)

In addition to estimates of instantaneous mortality ( $E_{s+j,k,l}$ ) described above, the ETM requires estimates for three other parameters,  $R_s$ ,  $D_{s+j,k,l}$  and  $C_{j,l}$ . Each of these three parameters and potential methods of estimation are discussed below:

*Relative Temporal Spawning Index ( $R_s$ )* provides a measure of the fraction of the total number of individuals which were spawned during each cohort, s. Mathematically, this is defined as:

$$R_s = \frac{N_s}{N_{total}} \tag{eq. 2-26}$$

where:

- $N_s$  = Number of young produced during interval (s)
- $N_{total}$  = Total number of young produced throughout the year

For most entrainable organisms,  $R_s$  is defined in terms of egg production. However, for live-bearers or those species with parthenogenic reproduction,  $R_s$  can be defined in terms of a later lifestage. In all cases, the sum of  $R_s$  across the year is equal to 1.

Most commonly,  $R_s$  is calculated based on a field sampling program designed to estimate the standing crop of eggs (or other early lifestage) of each target species for each model time step across the year. In estimating  $R_s$  from such information, consideration must be made of changes in lifestage duration (especially temperature related) which can alter the total number of young estimated within each model time step from the same standing crop. Further, consideration must be given to potential differences in the subsequent natural survival of the young produced within each model time step. In lieu of having site-specific empirical data to estimate  $R_s$ , an estimate of the relative spawning index can be generated using information of the presumed temporal pattern in spawning, such as might be estimated from a known spawning-temperature relationship. Such a step introduces an additional source of uncertainty

which must be recognized; the potential level of uncertainty could be evaluated by varying  $R_s$  in a sensitivity analysis of the model.

*Proportion of Each Lifestage Within Study Area ( $D_{s+j,k,l}$ )* provides a measure of the fraction of the total abundance of lifestage (l) residing within region (k) during model time step (s+j). Mathematically, this is defined as:

$$D_{s+j,k,l} = \frac{N_{s+j,k,l}}{N_{s+j,l}} \quad (\text{eq. 2-27})$$

where:

$N_{s+j,k,l}$  = Number of organisms at lifestage (l) which are in region (k) during model time step (s+j)

$N_{s+j,l}$  = Total number of organisms at lifestage (l) in the receiving water body during model time step (s+j)

In all cases, the sum of  $D_{s+j,k,l}$  across all regions within a model time step is equal to 1.

As with  $R_s$ , estimates of  $D_{s+j,k,l}$  are most commonly developed from site-specific field sampling programs which are used to estimate the standing crop of each entrainable lifestage in each region during each model time step. When the selected model time step is not comparable to field sampling intervals (e.g., model time step is weekly, but sampling is conducted on alternate weeks), professional judgment and manipulation of the data (e.g., interpolation) can be used to fill in missing data. In lieu of having the appropriate site-specific geographic information, estimates of  $D_{s+j,k,l}$  can be developed using existing information from other years, sites or similar species, or a presumed geographic distribution pattern for each species; as for  $R_s$ , such a step introduces an additional source of uncertainty which should be evaluated on a site-specific basis.

*Fraction of Number in Lifestage During Age ( $C_{j,l}$ )* provides a measure of the fraction of the total number of a cohort existing at any time (j) which is of lifestage (l). Estimates of this parameter are typically developed from estimates of lifestage duration compared to the length of the model time step. For example, if the length of time step 1 is 7 days and the duration of lifestage 2 in that time step is 3 days, then  $C_{1,2}$  is 3/7 or 0.43.

Simplifying assumptions can be made for each of the input parameters described above as appropriate. For example, if all eggs are produced during one model time step, the ETM equation described above collapses to a much simpler form. In addition, should natural mortality vary considerably either spatially or temporally or both, this model can be modified accordingly by adjusting the duration of selected model interval time steps (e.g., changing a specific weekly interval into seven daily intervals) or the extent



of geographic model zones (e.g., subdividing a zone during selected time steps. Such modifications will result in exceedingly complex equations. Such model simplifications and modifications are described in Boreman et al. (1978).

There are three principal assumptions related to the use of the ETM. The extent to which the biological system being assessed and the model input variable are consistent with these assumptions will have an important effect on the uncertainty associated with the projections and, ultimately, the credibility of the model results. The first of these is that populations of the target species within the receiving water body are closed. That is, there is no significant immigration or emigration during the period of entrainment vulnerability. The occurrence of either process introduces uncertainty and results in biased estimates of conditional mortality; an overestimate in the case of immigration and underestimate for emigration. For many model applications it has been necessary to set artificial model boundaries on the geographic range wide spread populations, thus not accounting for the natural movement of organisms across the boundary with the contiguous population. The second principal assumption is that lifestage durations are constant for each cohort. For example, if the duration of the second lifestage is 3 days for the first cohort, the duration of that lifestage will also be 3 days for each subsequent cohort. If the duration increases or decreases among cohorts, vulnerability to entrainment will increase or decrease, respectively, for that lifestage. The third major assumption is that lifestage-specific natural mortality rates are constant across time and space. In other words, it is assumed that the natural mortality of any specific lifestage is constant for each cohort and region; as indicated above, when this assumption does not appear to be valid, the time step or zone should be modified. The second and third assumptions provide the basis for using the temporal pattern in spawning (i.e.,  $R_s$ ) to predict that the temporal pattern is in abundance of all subsequent lifestages.

## Application

The ETM has been widely used by both utilities and regulatory agencies as a tool for assessing the potential for adverse environmental impacts from entrainment through cooling water systems at a variety of power plants. While most applications have been in estuarine systems, there is no reason that this model could not be adapted for other systems as well. Following publication, the ETM model was quickly selected as the conditional mortality rate model of choice for the Hudson River case and became the model upon which all settlement negotiations were based (Englert and Boreman 1988, Boreman and Goodyear 1988). It remains an important part of the ongoing impact assessment for Hudson River generating stations (Central Hudson Gas and Electric Company, Inc. [CHG&E] et al. 1993). In addition, the ETM was used by both the utility (PSE&G 1984, 1985) and regulatory agencies (Versar 1989a) as part of the environmental impact assessment of the Salem Generating Station on the Delaware estuary. This model was also used by both utility and regulatory agencies for impact assessment of the proposed Dorchester Power Plant on the Nanticoke River (Delmarva Power 1993). The ETM has also been used as a preliminary assessment tool for the Edgemoor Power

Plant on the Delaware estuary (EA 1992) and has been used to assess the potential environmental impacts of dredging on the tidal Delaware River, and of drinking water withdrawals from the Hudson River estuary (EA 1996a). The model was also applied for assessment of cooling water intake effects at the Bayway Refinery on the Arthur Kill in New Jersey.

As with each of the fractional loss models, the results of the ETM do not provide a measure of the total effects of cooling water withdrawals on the aquatic populations in the receiving water body. Such an assessment must also consider the magnitude of other sources of mortality on the populations, as well as the existence of compensatory processes within the specific populations of interest.

### 2.3.3.3 Empirical Impingement Model

The Empirical Impingement Model (EIM) provides a means for estimating the conditional mortality rate resulting from the loss of individuals as a result of power plant operations (Table 2-9). It is empirical in the sense that it is based on estimates of loss and initial population size which are both typically empirically derived. While the name indicates that this model is for estimation of losses due to impingement, the model is equally applicable for the estimation of fractional loss from any power-plant-related stresses. This model was first described in detail in Barnthouse et al. (1979).

The EIM is based on equations for a Type II fishery based on the classical fishing theory developed by Ricker (1975). A Type II fishery is one in which losses from man-induced causes and natural (background) causes occur coincidentally and are independent. This model follows a single cohort of organisms from the time they first become vulnerable to power-plant-related effects until they are no longer vulnerable. Typically, the cohort used is the total production of young in any particular year. Using estimates of the number of individuals lost, the initial population size, and natural mortality rate for any set model interval, the EIM calculates a conditional mortality rate for that interval as follows:

$$CMR_i = 1 - [1 - (1 - CMR_i)(1 - n_i)]^{\frac{I_i}{N_0}} \quad (\text{eq. 2-28})$$

where:

$CMR_i$  = Conditional mortality rate for power-plant-related effect for time interval (I)

$n_i$  = Conditional natural mortality rate for time interval (I)

$I_i$  = Number of individuals in cohort lost as a result of power plant operations in time interval (I)

$N_0$  = Total population size of cohort at beginning of time interval (I)

As can be seen, this equation is transcendental; that is, there is no explicit solution. However, a numerical solution can be found by iterative substitution.

Typically, however, the EIM is based on more than one time interval. This is to account for seasonal patterns in the power plant operations and species vulnerability. In the multiple time interval situation, separate values for  $n_i$  and  $I_i$  are required for each interval, and the initial population size for each interval is sequentially estimated from the results of the previous intervals as follows:

$$N_{0,i} = N_{0,1} \prod_{i=1}^I [(1 - CMR_i)(1 - n_i)] \quad (\text{eq. 2-29})$$

where:

$N_{0,i}$  = Initial population size for time interval (I)

$N_{0,1}$  = Initial population size for the first time interval

I = Total number of time intervals (I) affected by power plant operations

Using this information, estimates of conditional mortality are then calculated sequentially for each time interval (I) and the total conditional mortality ( $CMR_T$ ) is determined as:

$$CMR_T = 1 - \prod_{i=1}^I (1 - CMR_i) \quad (\text{eq. 2-30})$$

In practice, estimates of  $I_i$  are typically made from site-specific studies, such as entrainment or impingement monitoring, or based on estimated exposures to pollutants, such as heat or toxic chemicals. Estimates of  $N_0$  have, most typically, been based on site-specific population studies, such as density extrapolations or mark-recapture experiments, while estimates of the natural mortality rate ( $n$ ) have been either developed from site-specific population studies (e.g., catch curve analysis), or obtained from the scientific literature.

There are three principal assumptions to the EIM. The first is that estimates of  $N_0$  reflect the entire population in the receiving water body. The second assumption is that the

probability of death for individuals from power-plant-related causes is independent of the probability of death from natural (background) causes. The third, and final assumption, is that the mortality rates due to power-plant-related causes and natural causes are both constant within each time interval (I). If the power-plant-related losses occur over a sufficiently long time period, such that the third assumption becomes problematic, then the use of multiple time intervals for the assessment is warranted. The duration of assessment time intervals is selected by the investigator taking into consideration the duration of the species/lifestage, but are typically on the order of days, weeks, or months.

### **Application**

The EIM has been used as a tool by both the utilities and regulatory agencies for assessing the potential for adverse impacts from impingement against cooling water intake screens at several power plants. While applications to date have been limited to estuarine systems, this model is equally adaptable to any aquatic system. In addition, as previously noted, this model can be used to estimate conditional mortality rates from any source of power-plant-related mortality, not just impingement. The principal factor limiting more wide-spread application of this model appears to be the requirement for population and natural mortality rate estimates for the receiving water body. Such information is rarely available without costly, and time-consuming, site-specific studies.

The EIM was originally developed to help assess the potential for adverse environmental impacts from impingement for the five power plants operating on the Hudson River estuary (Barnthouse et al. 1979; Barnthouse and Van Winkle 1988, Vaughan 1988). Subsequently, the EIM was used as part of the assessment of impingement impacts at the Salem Generating Station (PSE&G 1985; Versar 1989a) and as part of the assessment of potential impingement impacts resulting from drinking water withdrawals from the Hudson River estuary (EA 1996a). These calculations have also been used to estimate the fractional reduction in recruitment due to entrainment (Versar 1989b, 1989c; Loos and Perry 1989) at PEPCO's Chalk Point Steam Electric Station on the Patuxent River, and by Stroup et al. (1992) for Delaware Power and Light's (DP&L's) Indian River Power Plant.

As with each of the fractional loss models, the results of the EIM do not provide a measure of the total effects of power plant operations on aquatic populations in the receiving water body. Such an assessment must also consider the magnitude of other sources of mortality on the population, as well as the existence of compensatory processes within the population of interest.

#### **2.3.4 Hydrodynamic Models**

Hydrodynamic models are a category of fractional loss models which attempt to predict the spatial and temporal distribution (and hence the vulnerability of organisms)

through modeling the interplay between physical and biological processes (Table 2-10). In general, these models have been most commonly used to investigate planktonic organisms (e.g., smaller invertebrates and the early lifestages of fish) under the presumption that the movement of these lifestages can be successfully predicted based on the movement of water. While a number of well documented equations have been developed to represent various physical mixing, diffusion, dispersion, and transport phenomena, most hydrodynamic models which have been used for power plant impact assessment typically required site-specific modification and coupling of various equations to account for local/regional hydrodynamic conditions associated with a specific power plant or group of plants.

For an earlier EPRI methods review, LMS (1980a, Section 1.5) presented a discussion of generic model construction methodology for four typical river scenarios, three estuarine scenarios, and for a lake, bay or harbor location. The model variants described by LMS account for uniform and non-uniform distribution of organisms, sites with and without recirculation, completely mixed and tidally averaged with longitudinal dispersion, and compensation. The basic model and model construction methods presented were intended to provide guidance and the basic components needed to construct more complex, site- or waterbody-specific models. In addition, LMS (1980a) provided the basis for evaluating the relative significance of various physical and biological parameters in estimating entrainment losses, and the relative priorities for measurement and collection of various types of data as part of field studies. The guidance provided by LMS (1980a) was not designed to replace the need for expertise of trained hydrologists and fisheries scientists in constructing site-specific models, but to suggest various options and approaches to be considered. On a cautionary note, with nearly two decades of experience in the litigious Hudson River studies and hearings as a backdrop, Christensen and Englert (1988) warn that for entrainment and impingement impact assessment, “complex mechanistic models [such as these] are not necessarily better than simpler empirical models for young fish, and that care must be taken to construct even the simple models correctly.”

Many of the available hydrodynamic model applications have been for tidal river/estuary areas; these models provide an increase in mathematical sophistication in order to simulate tidal mixing and transport phenomena not readily addressed by the water ratio techniques discussed in Section 2.3.1. Recognizing that entrainment impacts depend on interaction of receiving water dynamics and plant operations in conjunction with plankton behavior, these models typically consist of two coupled components:

- A hydrological component which simulates the physical dynamics and mixing characteristics of the waterbody;
- A biological component which characterizes life history and behavioral features of the modeled taxa.

To best simulate hydrodynamic factors and organism distribution and transport conditions, these models typically require considerable field data stratified over tidal conditions for model calibration and validation, and to support reasonably powerful hypothesis testing (Bongers et al. 1975).

These models typically include mathematical functions to account for estuarine stratification associated with salinity and thermal density gradients, tidal and non-tidal flow layers, receiving water morphometry, thermal plume dispersion, recirculation, and plume residence time associated with tidal cycles. These functions are calibrated using data collected during *in situ* current velocity monitoring and dye dispersion studies over multiple tide cycles and a range of mixing conditions. Model validation using an independent data set is a critical phase of modeling which lends support for, or guides reevaluation of, the assumptions and hypotheses underlying the model structure. Models which have been developed as tools for predicting and evaluating power plant impacts and mitigation alternatives exhibit a wide range of complexity in their representation of the physical and morphological characteristics of the waterbody. As with population models, professional judgment and simplifying assumptions are required to develop a reasonably simplistic model which relies on input data that can be obtained through a cost-effective field study, but still generates a responsive and flexible representation of the system hydrodynamics. To some extent, the complexity of various models has been a function of the field monitoring, data logging, and computing technologies available at the time a particular model was developed. The following examples of hydrodynamic models are discussed in order of increasing complexity.

#### 2.3.4.1 Thermal Induced Plume Effects Model

Carter et al. (1977) developed the generic rationale for a modeling approach to integrate the hydrodynamics of thermal plume mixing and dispersion with thermal tolerance information to estimate the probability of plankton losses in the nearfield and farfield area associated with a thermal plume. This project was supported in part by New York State Energy Research and Development Authority and the generic model was then demonstrated for three diverse hypothetical habitats typical of many New York power plants. Their approach superposed nearfield (Shirazi and Davis 1974, 1976) and farfield (Pritchard 1960) models to describe dispersion of a thermal plume and then applied the integrated model to predict thermal dose exposure of organisms entrained into the plume for hypothetical unidirectional riverine and oscillatory estuarine sites. This physical model begins at the power plant discharge and does not include a component representing the power plant intake or cooling system. The model calculates time-temperature doses (EC seconds) for 100 hypothetical planktonic organisms distributed uniformly along the centerline of the plume to produce a dose probability curve. This curve is then compared to time-temperature thermal resistance curves for selected species. These resistance curves were generated based on laboratory thermal tolerance

data from the scientific literature. The species selected to perform this step were identified as RIS for hypothetical locations on Long Island Sound, the lower Hudson River and Lake Ontario. The result is an estimated probability of losses from plume entrainment.

#### 2.3.4.2 Generalized Hydrodynamic Transport Model

Edinger and Buchak (1975, 1978) and Buchak and Edinger (1982a, 1982b, 1984) have developed a series of hydrodynamic models which have been used to simulate mixing and particle (organism) transport in aquatic systems including the power plant cooling system effects. The Generalized Longitudinal-Vertical Hydrodynamics and Transport (GLVHT) model has been developed as an efficient implicit numerical model for use on rivers, reservoirs, lakes, and estuaries. GLVHT is a numerical, two-dimensional, laterally averaged hydrodynamic and water quality model that describes the vertical and longitudinal distribution of water body parameters through time. GLVHT includes the effects of variable density and wind stress in the flow field and calculates surface elevations, vertical and longitudinal velocities, temperature, and constituent concentrations. The equations are solved implicitly, permitting the use of longer time steps and thus, shorter execution times for typical modeling periods. A second version of the model, GLLHT, is a two-dimensional, vertically averaged hydrodynamic model which describes the longitudinal and lateral transport of water body parameters. This alternative version of the model is suitable for use in shallow water bodies where the lateral distribution is of greater importance. A fully three-dimensional form of the model, GLLVHT, developed since 1985, provides generalized longitudinal, lateral, and vertical hydrodynamics and transport.

#### 2.3.4.3 Potomac River Model

Bongers et al. (1975), Polgar et al. (1976), and Polgar et al. (1981) summarize the development and validation of a hydrodynamic model for predicting zooplankton population depletion in the Potomac River in the vicinity of the Morgantown Power Plant. Development of this model was supported by the Maryland Power Plant Siting Program. The model simulates mixing in a two-layer, partially-mixed estuary with significant tidal recirculation of thermal discharges to the cooling water intake, and predicts zooplankton densities at various lifestages in defined nearfield (intake), intermediate, and farfield zones. Ratios of model-predicted nearfield to intermediate and farfield zooplankton densities were used to quantify entrainment-related depletions. These predicted ratios were compared to observed field density ratios. The comparison indicated that the model underestimated local depletions, and that other factors in addition to through-plant entrainment effects were influencing local zooplankton densities. The authors proposed several hypotheses to account for the differences between predicted and observed conditions. Polgar et al. (1981) also incorporated an economic submodel to equate predicted power plant losses to a

proportional change in the value of the commercial fishery for selected RIS, and an ecosystem submodel to estimate the proportional loss of net productivity to the ecosystem food chain due to entrainment losses.

#### 2.3.4.4 Cape Fear FPM

The Cape Fear estuary fish population model (FPM) is a two-part hydrodynamic model developed for Carolina Power & Light Company to simulate the physical and behavioral mechanisms which influence the recruitment of early lifestages of spot (*Leiostomus xanthurus*) and Atlantic croaker (*Micropogonias undulatus*) from offshore spawning areas to estuarine nursery areas, and for use as a tool for evaluation of the influence of human-induced perturbations in the estuary. Lawler et al. (1981; 1988) used a three-dimensional, steady-state salt-budget model to describe the circulation patterns and hydrodynamic characteristics of the Cape Fear estuary. The complex geometry of the Cape Fear estuary and strong ocean influence on circulation required that considerable segmentation be incorporated into this model to quantify net non-tidal flows through the estuary. In this model the 60-km-long estuary was depicted with 28 longitudinal segments, each typically consisting of four lateral cells: upper and lower mid-channel layers, and east and west shoal upper layers. Salinity data to drive the salt-budget model were obtained from three intensive salinity surveys at multiple transects under a range of freshwater flow conditions. Data from five tracer dye and current surveys were used to estimate water exchange rates between the estuary and adjacent ocean. The biological component, the FPM, integrates the hydrodynamic aspects of early lifestage transport and later behavioral factors to simulate movement into the estuary; distribution of organisms among three primary habitats (mainstem channel, tributaries, and marginal high-marsh areas); natural mortality; diel vertical migration; and growth between lifestages of these two species within the estuary. Transport of primarily planktonic lifestages is represented by advective terms in the model equations, whereas distributions of older lifestages with stronger swimming capabilities were characterized from field survey ichthyoplankton data. Initial model runs were made using assumed values for some input parameters for which field data were not available; as part of the calibration process, these assumed values were adjusted stepwise until "satisfactory agreement" between field distribution data and the model output was attained. Satisfactory agreement was defined by the authors to occur when model output fell within two standard errors (approximately the 95 percent confidence interval) on either side of the field calculated means.

#### 2.3.4.5 Hudson River Striped Bass Life Cycle Model

During the 1970s and early 1980s, several variations (and generations) of a striped bass (*Morone saxatilis*) life cycle model, incorporating a hydrodynamic component were developed for the Hudson River by consultants to the Hudson River Utilities (LMS 1975, Lawler et al. 1974, McFadden and Lawler 1977, CHG&E, et al. 1993) and staff at



Oak Ridge National Laboratory, consultants to EPA (Eraslan et al. 1982). Christensen and Englert (1988) summarize the evolution and proliferation of population models in conjunction with the Hudson River case. The basic Life Cycle Model described by Lawler et al. (1974) starts with a one-dimensional physical model to predict transport and distribution of eggs and larvae. That model consists of a partial differential equation to describe downstream transport through a series of river segments. The equations are similar to those used in physics and engineering to model physical transport processes. The model accounted for averaged tidal effects using an augmented dispersion coefficient. This equation is solved sequentially from the upstream segment integrating across segments using standard numerical methods. Additional terms are added to the model to simulate features of the striped bass life cycle, including the behavior of individual lifestages, natural and power-plant-related mortality, growth through the first year of life in the Hudson river, and egg production of spawning adults from maturation through age 13. Three general categories of input parameters were identified:

- Fish life cycle parameters—e.g., egg production, survival rates and compensation, migration, spawning stock characteristics
- Mass transport parameters—e.g., convection, dispersion, river geometry
- Plant and impact parameters—e.g., plant operating characteristics, patterns of entrainment and impingement

The model is constructed to accept input parameters treated stochastically or as long term constants. The model is constructed to account for losses in multiple river segments in order to serve as a tool for assessment of effects of multi-plant losses on the population. The validity of the approach and the specific methods for incorporating compensation into the model were topics for considerable controversy and debate during the course of the Hudson River studies (McFadden 1977; Goodyear 1977; VanWinkle 1977; Christensen et al. 1982a, 1982b; Savidge et al. 1988; Lawler 1988; Christensen and Goodyear 1988; Fletcher and Deriso 1988). Model output includes estimates of:

- Distribution and population size at the end of each lifestage for conditions with (impacted) and without the plants (base) operating
- Fractional reduction in each lifestage
- Cumulative reduction from egg through young-of-the-year
- Cumulative reduction in the total population

The striped bass model was designed to operate with or without biological compensation. Without compensation, the population in the model for the base

conditions exhibits unbounded growth or decay unless the model is forced to operate at equilibrium.

#### 2.3.4.6 Real-Time Life Cycle Model

The next step in the evolution of the Hudson River striped bass life cycle model represented a marked improvement in the ability to simulate the distribution and movements of entrainable lifestages due to the two-dimensional capability for modeling the interaction of organism vertical migration and tidal transport (LMS 1975; McFadden and Lawler 1977). For this modification the model was divided into two equal depth layers and tidal action was simulated on a real-time basis with interaction between the surface and bottom layers. To enhance model stability the River was divided into 29 longitudinal segments which varied in length from 2 to 10 miles. Smaller segments were used in the vicinity of the power plants. The geometric characterization of the segments takes into account the complex morphometry of each segment in terms of volume, transport, and storage in the main channel, adjacent shoals, and more remote shoals and bays. The Real-Time Life Cycle (RTLCL) Model, as this became known, simulated the hydrodynamic function and organism distribution on a 3-hour time step. Distribution of eggs, larvae, and juveniles is determined primarily by the hydrodynamic transport equation with an additional term to account for vertical migration of larvae and longitudinal migration of juveniles. The model also accounts for differences in the lateral distribution of eggs and larvae across a river cross-section and the zone of withdrawal for each power plant through the  $w$ -ratio (similar to the simple water ratio and RPC methods described in Section 2.3.1.1) incorporated as a plant operational parameter (McFadden and Lawler 1977). Other parameters related to plant operation incorporated into the RTLCL model include plant location, plant flow rates, impingement rates, and for entrainment, a series of individual factors which comprise the composite  $f$ -factor (i.e., proportion of the water mass entering the plant [ $f_q$ ], percentage of the organisms entering the plant [ $w$  ratio], entrainment survival rate [ $f_c$ ], and recirculation rates [ $f_3$ ]). The adult life cycle portion of the model (age 2-14 years) is identical to the Leslie matrix approach (see Section 2.4.1). Compensation (density-dependent mortality) is expressed in the RTLCL model as a Beverton-Holt function, calibrated through the Ricker stock-recruitment analysis (see Section 2.4 for additional information on these population predictive methods). System variability was integrated through stochastic treatment of parameters representing freshwater inflow to the river, temporal and spatial distribution of spawning, and composite  $f$ -factors (i.e., via variability in the  $w$  ratio).

#### 2.3.4.7 Winter Flounder Stochastic Population Dynamics Model

A similar model was developed for evaluation of the effects of the Millstone Nuclear Power Station on the Niantic River/Bay winter flounder population (Northeast Utilities Environmental Laboratory [NUEL]1990, 1993). The winter flounder stochastic

population dynamics model is a multiple component model including a simulation of population dynamics based on a Ricker stock-recruitment relationship for early lifestages up to age-1 and Leslie matrix equations (see Section 2.4.2.1) beyond one year of age. Extensive field surveys provided input data for modeling larval behavior. These data included estimates of temporal and spatial distribution of yolk-sac larvae from which hatching rates were estimated; daily growth rates as a function of temperature; average weekly water temperature; daily larval survival rates as a function of age; diel and tidal behavior as a function of age; and mortality due to entrainment as a function of size. The physical component for simulation of larval dispersal and entrainment consists of a two-dimensional, depth-averaged particle tracking model developed by the MIT Energy Laboratory (Dimou and Adams 1989). The model makes use of the stochastic simulation of population dynamics based on Monte Carlo methods as a framework for a probabilistic risk assessment of stock reductions from three different levels of entrainment at Millstone. Mean stock size and standard errors were estimated from random replicates of the stock time-series generated from the Monte Carlo analysis.

## **2.4 Population Projections**

Another approach to assessing the effects of power-plant-related losses is to examine the effect of plant operations on the equilibrium population level of organisms in the source waterbody (Lawler and Englert 1978). Population projection models attempt to predict the consequences of the identified power-plant related effect(s) on the long-term abundance and/or persistence of the population of interest (population equilibrium). These models can be run in a deterministic or stochastic mode. Deterministic models use single value estimates for model input parameters and produce single estimate results. Stochastic models attempt to reflect some of the inherent variability of natural systems, representing selected input variables by a range or statistical distribution rather than a single point estimate; the resulting model output presents a range of potential effects given the variability of the environmental input parameters. Many of the models in this class are also commonly used to assess resource management alternatives for commercially and recreationally important fish stocks. However, it is important to note that commercial and recreational fishing principally targets larger sub-adults and adults for harvest, whereas power plant operations at many sites may primarily affect early lifestages including eggs, larvae, and juveniles less than 1 year old. Consequently, as many of the standard fisheries management models tend to lump the younger age groups into a the broad category of "pre-recruits," the applicability of some of these fisheries management models to the issue of power plant effects may be limited to sites where aquatic populations are primarily affected by impingement of older individuals.

For the purposes of this review, population models have been broadly grouped into three classes:

- Composite models--analysis aggregated at the population level
- Age/cohort structured models--analysis aggregated at the age/size/cohort level
- Individual-based models--track individuals in a population

While each of these classes reflect legitimately different approaches to the modeling of populations, actual practical applications have often combined elements from one or more of these classes.

### **2.4.1 Composite Models**

Composite models attempt to predict the abundance of the population at some future time based on the abundance at the present, future production of progeny, and average mortality. These predictive models are typically calibrated utilizing empirical data; however, they have occasionally been applied in retrospective time-series analysis of patterns in long-term databases. Generally, these models do not distinguish between ages or cohorts within a population but include a density-dependent population regulatory mechanism. Most manifestations of these “yield” models are variations on the same general theme developed as predictive tools for management of various commercial and recreational fisheries. Extensive empirical data are used to estimate levels of fishing mortality which will allow what until recently was typically referred to in fisheries management as “maximum sustainable yield.” Composite models are basically concerned with determining the productivity, or sustainable yield, obtainable from a fish population under various population conditions and patterns of fishing mortality which will maintain the population at some optimal condition or size (Royce 1972). When applying such models to power plant impact assessment, power-plant-related losses are treated as an incremental part of the fishing mortality or yield estimate, and the management objective is, thus, to evaluate the effect of this incremental harvest on maintenance of the population at optimal conditions. Examples of such classic management-based yield models include:

- Logistic population growth model
- Ricker stock-recruitment model
- Beverton-Holt stock-recruitment model
- Biomass dynamic models

Examples of the application of these types of composite models to power-plant-related effects are provided in Savidge et al. (1988) and Lawler (1988); however, such applications for power plant impact assessment have not been without considerable controversy (Christensen and Goodyear 1988; Fletcher and Deriso 1988), particularly as

to the use of density-dependent biological compensation in evaluating power plant loss projections. These analytical methods have also been incorporated as *components* of more complex population lifecycle models (e.g., McFadden and Lawler 1977; Section 2.3.4).

#### 2.4.1.1 Stock-Recruitment Models

Stock-recruitment relationship (SRR) models (Table 2-11) in various forms are used to represent the number of progeny that will reach spawning age (recruits) as a function of the size of the spawning stock (spawners) which produced them. Christensen et al. (1977) state that, “stock-recruitment theory is particularly applicable to simulation modeling of fish populations if recruitment (the probability of survival of an egg to a yearling or to an adult stage) is a decreasing function of stock size, that is, if compensation is operating in a population.” These models were developed for and have proven extremely useful as a tool to guide fisheries management decisions, and have been widely applied to assessing impact from various sources of mortality (e.g., power plant entrainment and impingement) other than commercial and recreational fishing harvest. As suggested, the traditional application of stock-recruitment theory in fisheries management was for assessing of the impact of the harvest of adults or subadults by a commercial or recreational fishery on a fishery stock. In contrast, entrainment and (at some locations) impingement losses typically affect younger lifestages and thus require a somewhat different application of stock-recruitment theory (Christensen et al. 1982a). Because this power-plant-related loss of individuals typically occurs before recruitment, Christensen et al. (1982a) proposed that “stock-progeny” is more accurate terminology, although the model mechanics are basically the same. The use of SRR models for power plant impact analysis has been the subject of considerable scrutiny with a review of the basic applications by LMS (1980a) and a series of papers evaluating the application of SRR models to Hudson River fish stocks (Christensen et al. 1982a, 1982b ; Lawler 1988; Christensen and Goodyear 1988; Fletcher and Deriso 1988; and Savidge et al. 1988).

A few definitions are provided at this point to facilitate an understanding of the basic concepts of stock-recruitment theory:

A **stock** is more or less loosely defined on a geographic and/or genetic basis as a unit or subdivision of a population. For impact assessment, this definition may be very site-specific. Depending on the data available and the assessment framework, the stock may be defined to include only spawning adults, or adults and subadults, or all individuals greater than one year of age.

**Recruits** are those individuals which survive from fertilized eggs to enter the above defined stock; for example, those fish reaching one year of age or those fish spawning for the first time.

A **reproduction or recruitment curve** is a plot of some measure or index of recruitment against stock.

Ricker (1975) identified several desirable traits of any recruitment curves:

- The curve should pass through the origin, so that when there is no adult stock there is no reproduction
- The curve should not fall to the abscissa at a higher stock level, so that there is no point at which reproduction is completely eliminated at high densities
- The rate of recruitment should generally decrease with increase in parental stock
- For a viable stock, recruitment must exceed parental stock over some part of the range of parental stock values, otherwise the stock will not persist

One underlying assumption of SRR is that the population is at equilibrium; an equilibrium population is one in which recruitment of progeny is equal to the parental stock. That is, reproduction and mortality are balanced such that each parent is replaced one for one by their progeny. On a recruitment curve (Figure 2-1) this is the point at which the curve intersects a 45E diagonal line through the origin. Surplus reproduction or potential yield for a fishery is represented by the vertical distance of the recruitment curve above the 45E equivalency line. The balance between progeny and parental stock occurs under some interaction of density-dependent and density-independent environmental factors. Density-dependent factors are typically biotic factors which affect survival/mortality rates as a function of the density of the population/lifestage, for example, competition for food and habitat, cannibalism, and susceptibility to predators. Although circumstantial evidence for density-dependent mortality/survival appears in fisheries literature and is an important, inherent assumption in management of commercial and recreational fish stocks, it has been difficult to directly demonstrate. Density-independent environmental factors such as water temperature, water flow rates, water surface elevation, and storm events exert a more readily quantifiable proportionate effect on a population. The potential influence of density-independent effects due to human activity can often be measured directly in such forms as exploitation rates or dose response curves.

The basic assumption underlying SRR models is that the stock exerts some influence on the abundance of recruits in conjunction with other density-dependent and density-independent factors. Entrainment and impingement and other power-plant-related losses of organisms introduce an additional source of density-independent mortality on a stock. The relative importance of the many factors which may influence recruitment can vary among sites, years, species, and lifestages. One of the major advantages of the SRR approach is, that it is not necessary to fully understand or unravel the complex mechanisms and interactions among all the potential density-dependent and

independent influences (LMS 1980a). In contrast to more complicated life cycle and individual-based population models, SRR models need only a time line of population abundance, rather than determining an array of other population parameters and constructing mathematical functions to account for a generally unknown level of compensation.

Despite the advantages of simplicity afforded by the SRR approach, several limitations must be recognized before applying it to a specific population (LMS 1980a). The foremost limitation is that the method requires a relatively long time line (on the order of 10 years) of annual abundance estimates in order to describe the SRR curve equation. Even with such a time line of data available, it may be difficult to construct an appropriate SRR curve if the available spawner abundance data do not encompass a wide range, because most basic models differ at the extremes of high and low spawner abundance. The results of SRR modeling assume a stable age distribution which is frequently not supported by the detail, quantity, and duration of the data available (Christensen et al. 1982a, 1982b). For multiple-age spawning stocks (e.g., striped bass [*Morone saxatilis*], bluefish [*Pomatomus saltatrix*], American shad [*Alosa sapidissima*], largemouth bass [*Micropterus salmoides*]), annual age composition information should also be incorporated into the exercise. LMS (1980a), Christensen et al. (1977), and Leggett (1976) describe the specific modifications to account for multiple-age spawning stocks. Because a number of environmental variables can affect spawning success (e.g., water temperature, freshwater flow, tidal exchange, etc.), and these may obscure the underlying SRR, the curve constructed for a specific stock may be applicable over a limited range of environmental conditions. This situation may be mitigated by integration of environmental data into the equation to account for some of this variability. Finally, many stocks for which adequate data are available are the target of commercial or sport fishery exploitation which in itself influences the SRR. Some measure of these sources of exploitation is desirable to document that exploitation has remained relatively constant, or to document how it has changed during the time line for the SRR (Leggett 1976).

Leggett (1977) evaluated factors which affected the SRR for a Connecticut River population of American shad. Although a relatively strong database existed for this population at the time, Leggett warned:

The potential for error in numerical predictions of the effect of proposed levels of increased mortality on pre-recruit stages is large, while the biologically acceptable range of error is small. This problem is compounded several fold in populations for which the relevant life-cycle parameters are less well defined, which includes the majority of commercially important fish stocks and virtually all noncommercial stocks. Until better understanding is achieved of the interacting roles of density-dependent and density-independent factors in regulating population size and stability, and until a much better database is available,...precise numerical predictions of the impact of this incremental

[power-plant-related] mortality on adult stocks should be interpreted with great caution.

Although considerable data are now available for some extensively studied commercial and recreational species, the information for most species is still very limited in 1998 and, thus, these cautions are still very much applicable and should be considered and evaluated for the species of concern at any given site. Despite these limitations, warnings, and cautions (but keeping them in mind), SRR models do provide a valuable tool for evaluating potential impacts and predicting relative differences between impact scenarios and mitigation alternatives.

Application of these SRR models requires an experienced fisheries scientist with an understanding of the relationship between the life history characteristics of the specific stock being analyzed and the theoretical and mathematical representation of those traits. Although any number of curves might be fit to empirical data encompassing a series of annual estimates of spawning-recruitment abundance for a population, the shape of the curve should have some reasonable theoretical foundation based on the underlying characteristics of the species' life history. Ricker (1975) observed that, "Unfortunately our knowledge of population regulatory mechanisms in nature is so slight that it is usually difficult to choose among different curves on this basis, so we usually fit the simple curve that looks most reasonable." Most applications of this method have used one of two families of models: the Ricker recruitment curve (Ricker 1954) and the Beverton-Holt recruitment curve (Beverton and Holt 1957). The primary differences between these two approaches is in their configuration at low and high spawner abundance. Ricker (1975) and Gulland (1974, 1983) discuss the attributes and development of both forms in the context of fisheries stock management. Ricker (1975) indicates that the Beverton-Holt form is more appropriate for populations whose abundance may be habitat or food limited, while the Ricker curve is more appropriate for populations whose recruit abundance is regulated primarily by factors related to spawning stock abundance. Christensen et al. (1977, 1982a, 1982b) describe a stock-progeny model which combines the characteristics of both the Ricker and Beverton-Holt models and targeted at analyzing mortality of young-of-the-year fish rather than recruits to the fishery.

The Ricker model exhibits peak recruitment at low to moderate spawner abundance, predicting declining recruitment at high spawner abundance (Figure 2-1). In this case it is assumed that recruit survival is determined in large part by the initial level of the spawning population. The basic Ricker equation is:

$$R = \alpha P e^{-\beta P} \quad (\text{eq. 2-31})$$

where:



$R$  = number of recruits

$P$  = number of spawners

$\alpha$  and  $\beta$  = constant parameters derived from field data.

The slope ( $\alpha$ ) at the origin of the recruitment curve (zero stock abundance) has been referred to as the compensatory reserve of the stock (Goodyear 1977; Shepherd 1982; Savidge et al. 1988) and is considered the most important parameter in the SRR. It is a function of parental egg production and survival when only density-independent processes are operating. The  $\beta$  parameter describes the annual rate of compensatory mortality as a function of stock size; that is, the density-dependent mortality rate. LMS (1980a) provides detailed information for derivation of the value of ( $\alpha$  and  $\beta$  for a given stock.

Leggett (1976) applied a Ricker curve for analysis of anadromous American shad multiple-age spawning population in the Connecticut River where a high proportion of adults spawn in multiple years. In contrast, PSE&G (1985) used a single-age spawning model to analyze impacts of the Salem Generating Station on the Delaware River American shad stock which has a very low incidence of multiple-age spawning adults. LILCO (1975a) applied a Ricker SRR model to menhaden in an evaluation of a proposed nuclear power plant at Jamesport, Long Island.

By contrast, the Beverton-Holt model depicts recruitment as increasing asymptotically toward some maximum level over the range of spawner abundance (Figure 2-1) and assumes that recruit survival is continuously density-dependent up to some critical age. The basic Beverton-Holt equation is:

$$R = \frac{I}{\alpha + \frac{\beta}{P}} \quad (\text{eq. 2-32})$$

LMS (1980a) also provides details for construction of the Beverton-Holt curve equation for a given stock and derivation of the associated parameters.

Hilborn and Punt (1993) applied three SRR models to evaluate the effect of entrainment and impingement, at what lifestage(s) compensatory mechanisms occur, and recreational fishery regulations on the Hudson River striped bass stock: Ricker model, Beverton-Holt model, and a broken-line model. The broken-line model assumes that recruitment is proportional to spawning stock size up to some critical stock size, above which recruitment is constant. SRR models were specifically used to relate total egg production to expected 0-year-old (young-of-the-year) abundance. The models included a parameter to account for variation on recruitment (recruitment anomalies)

affected by random variation in the environment. With appropriate parameterization, the authors found that all three SRR models appeared to represent the empirical data equally well for a population which has exhibited relatively constant young-of-the-year class strength over a wide range of historical spawning stock size, egg and larval lifestage abundance, and fishing pressure on the adult stock. The authors used the output of the Beverton-Holt model as a submodel in an age-structured population dynamics Leslie matrix model. Hilborn et al. (1993a, 1993b, 1993c, and 1993d) also used similar approaches to evaluate power plant effects on white perch (*Morone americana*), Atlantic tomcod (*Microgadus tomcod*), American shad, and bay anchovy (*Anchoa mitchilli*) populations, respectively, in the Hudson River.

Christensen et al. (1977) developed an equation which combined the Ricker and Beverton-Holt models; the equation generates a Beverton-Holt type SRR curve when the variable representing the density-dependent mortality rate due to cannibalism or intraspecific competition is set to zero. This equation carries progeny from eggs through the end of the first year of life to calculate the number of progeny recruited into the age 1 year class. The Christensen et al. (1977) version of the SRR model addresses multiple age spawning stocks by incorporating a series of distinct, single age class cohorts; a separate equation takes yearlings through all the older age classes, applying mortality to each age class to generate a “stock value” (SV) for a group of yearlings. The “progeny stock value” is calculated by multiplying the SV by the number of one year old progeny. The stock recruitment curve is then represented by plotting progeny stock value against stock size (all fish of the stock that are at least one year old).

Christensen et al. (1977) introduced two additional terms (DID and  $P_E$ ) derived from the SRR for evaluation of power plant effects. The density-independent depletion (DID) percentage is the potential reduction, after one year, in the number of one year old fish due to power-plant-related effects assuming compensatory (density-dependent) processes are not operating. Without compensation, increasing density independent mortality through the addition of power-plant-related mortality will result in a reduction of one year old progeny equivalent to the DID percentage. Eventually this progeny reduction will result in a reduction in the equilibrium stock size ( $P_E$  in Figure 2-1) or the “stock depletion percentage.” With compensatory processes operating, the SRR model is used to estimate the size of the equilibrium stock, both with and without power-plant-related mortality. The stock depletion percentage is then calculated as the fractional reduction in the equilibrium population due to power-plant-related mortality.

Christensen et al. (1977) evaluated the “impact factor” (ratio of stock depletion percentage to the DID percentage) as a measure of the sensitivity of a stock to power plant cropping and the sensitivity of this ratio to a number of population parameters. They observed that:

- The impact factor is positively related to the slope at the equilibrium point (that is, the potential sensitivity of the population to power plant cropping increases as the slope becomes more positive) and negatively related to the slope at the origin.
- The greater the deviation of the Ricker or Beverton-Holt curve from the 45E line, the less sensitive the stock will be to power plant cropping.
- The critical impact (the level of DID which is just large enough to cause extinction of the stock) increases (that is, the stock is more resilient) as the slope of the SRR curve at the origin increases. When the slope approaches unity the stock will eventually go extinct.
- As the slope of the SRR curve at the equilibrium point increases (that is, becomes more positive) the compensatory reserve of the stock decreases and the stock becomes more vulnerable to additional impacts.

A number of attempts have been made to account for deviations of empirical data from basic SRR model curves by incorporating important environmental variables into the analysis. One approach has been to regress data for environmental parameters against residuals. Additional exponential parameters have been used in some applications to help reduce recruitment variability and obtain more reliable parameter estimates for the SRR; e.g., a water temperature parameter during February was used to evaluate the effects of operation of the Millstone Nuclear Power Station on winter flounder recruitment (NUEL 1990). Other similar modifications to account for the influence of additional variables (e.g., water temperature, flow, salinity) on the SRR have been developed including Nelson et al. (1977), McFadden et al. (1978), Lawler and Englert (1978), and Yoshiyama et al. (1981).

Lawler and Englert (1978) describe a procedure for developing a probability distribution of impact by stochastically varying selected parameters in the SRR model. Using historical distribution characteristics of selected parameters, parameter input values can be selected randomly and repeated model calculations yield a distribution of impact estimates. This process can be accomplished using Monte Carlo methods.

Another advantage of this category of population assessment methods is that the form that input data for SRR analysis can take is flexible. Numbers of recruits/progeny and spawning stock have been represented as estimates of absolute numbers and on a catch-per-unit-effort (CPUE) basis. Where reliable estimates of the spawning stock size are available (e.g., migratory stock counts at a fish ladder), egg production based on average fecundity can be adjusted downward for natural mortality to generate estimates of one year old progeny/recruits. Data on abundance or density may be derived from plankton and nekton field studies designed as part of the impact assessment (including pre- and post-facility operation if available), from resource management agency stock assessment studies, or from commercial/recreational catch

records. For stocks which exhibit a relatively high incidence of individuals spawning during more than one year, accurate age structure information for the spawning stock can greatly enhance the reliability of the SRR analysis.

#### 2.4.1.2 Logistic Population Growth Model

Ecologists have observed that the shape of a population's growth plotted over time for a population at equilibrium released from some level of exploitation (e.g., closing a commercial or recreational fishery) will be a sigmoidal or logistic curve (Figure 2-2) (Gulland 1983, Ricker 1975, and Royce 1972). Similar to the stock recruitment approach which examines population size, the logistic population growth model (Table 2-12) can be used to examine the ability of the population to sustain a given level of power-plant-related mortality in terms of biomass. The form of the equation for the logistic growth model is:

$$B = \frac{B_{\infty}}{1 + e^{-k(t-t_0)}} \quad (\text{eq. 2-33})$$

where:

B = population mass

$B_{\infty}$  = limiting population mass at environmental carrying capacity

$t_0$  = is a time constant that adjusts the origin of time scale to the inflection point of the curve

k = rate constant for population approaching  $B_{\infty}$

Under this scenario the natural rate of population increase reaches a maximum at the inflection point on the curve, decreasing to zero in one direction at zero population size and in the other direction at the limiting population size (at the carrying capacity of the environment). Theoretically, the equilibrium catch or yield is a parabolic function of both effort and the population size (Figure 2-2). That is, yield per catch increases with fishing intensity (effort) until the stock size decreases to half of the maximum equilibrium size of the unexploited population. Further increases in fishing effort will not produce an increase in yield, but a decrease in yield.

#### Application

LMS (1980a) examined a modification of this population growth theory in order to evaluate potential density-dependent factors which affect population abundance trends

relative to power plant operation. From a practical standpoint, in a well designed field sampling program, catch per unit of effort (CPUE or  $C/f$ ) will be a function of population size and can serve as a surrogate for population size in the analysis. From a series of annual estimates of mean  $C/f$ , the population growth rate is estimated for each annual interval and then plotted against  $C/f$ . Using data for four Hudson River fish populations (striped bass, white perch, Atlantic tomcod, and hogchoker [*Trinectes maculatus*]), LMS (1980a) found a negative exponential relationship between population growth rate ( $r_t$ ) and  $C/f$ :

$$r_t = a - b \cdot \ln(C/f) \quad (\text{eq. 2-34})$$

where  $a$  and  $b$  are intercept and slope constants. The negative correlations between these two measures for each of the four fish populations were identified as an indication of density-dependent mechanisms at work in the populations. Figure 2-3 provides an example of the application of this method to the Hudson River striped bass annual young-of-the-year indices.

Intersea Research Corp (1981) used this type of production model to assess the effects of impingement of queenfish (*Seriphus politus*) and shiner surfperch (*Cymatogaster aggregata*) in terms of maximum sustainable yield or maximum allowable impact at the Haynes Generating Station in Los Angeles. MacCall et al.(1983) applied a similar logistic curve-based production model to assess the effects of power plant operation on the marine topsmelt (*Atherinops affinis*) in another California estuary. MacCall et al. (1983) acknowledge that the logistic production curve approach has been subject to many criticisms, but point out that "in actual practice it is often the only available basis of fishery management," and due to the parallel goals, is a useful technique for analysis of power plant impacts. Because maximum yield occurs at half the un-impacted population abundance, the authors proposed an impact criterion of total natural and unnatural mortality not to exceed 50 percent of the un-impacted abundance. They also suggested that improvements to the method could be attained if the shape of the productivity curve is customized to the specific stock and if species-specific scaling criteria are developed for the production curve based on a detailed understanding of the population characteristics.

The only data required to conduct this exercise is the mean  $C/f$  from a population sampled at regular intervals (e.g., at the end of the annual growing season over a number of years).

#### 2.4.1.3 Yield-Per-Recruit

The yield-per-recruit (i.e., yield, as average biomass per recruit or average biomass per unit weight of recruits) approach (Table 2-13) is a basic fishery management technique

which has been used to evaluate immediate and long-term effects of different regulatory actions and to provide support for decisions on regulation of fishing pressure (Gulland 1983, Ricker 1975, Royce 1972). The main objective of yield-per-recruit techniques in fisheries management has been to provide advice on the likely results of changes from the existing conditions/regulations governing a fishery. The method focuses on two fishery parameters which can be controlled: the amount of fishing, as measured by the fishing mortality; and the way fishing mortality is distributed across different size/age classes (Gulland 1983). The analysis is focused on age classes which have already been recruited to the fishery and thus minimizes the difficulties and uncertainties (inherent in other analyses) related to estimation of number of factors (e.g., density-dependent and independent mortality, and adult influence on year-class strength) which may strongly influence abundance at young-of-the-year and earlier lifestages, but are difficult to reliably quantify. That is, the age at which the analysis is performed occurs after much of the influence of this wide range of factors has been realized. The method is particularly useful for fish stocks which exhibit highly variable recruitment, determined primarily by environmental factors and, for the most part, independent of adult stock size.

The yield per recruit method has most commonly been used to estimate the effect of regulating the amount of fishing effort, gear selectivity, and size limits on a fishery. The method has not received wide application to power plant effects. It may, however, be useful at plants where impingement or other operational impacts affect primarily age-one and older fish.

As with other composite population models (Section 2.4.1), yield-per-recruit models generally assume that the population is at equilibrium. Additional requirements for the application of this technique are that instantaneous mortality and growth rates at a given age are constant over the range of population conditions studied. To assure that these conditions are met and that potential associated error is small, the population is typically broken up into age, size or time intervals sufficiently small such that the assumptions are reasonably acceptable (Ricker 1975). Yield from each interval is summed to estimate the yield from the whole stock. The assumptions of equilibrium and independence of recruitment relative to adult stock size lead to an associated assumption that yield from a cohort is proportional to the number recruited, thus yield per recruit is proportional to yield from the stock and it is not necessary to estimate the actual number of recruits to the stock in a year.

Gulland (1983), Ricker (1975), and Royce (1972) summarize the derivation of several common equilibrium yield equations from Ricker, Beverton-Holt, and Baranov, and provide examples of their use for fishery management applications. Although the formulations are complex, the solutions can be readily accomplished by an experienced fisheries scientist using a tabular/spreadsheet operation. The various formulations all basically express yield as a function of fishing mortality, natural mortality, total mortality, number of recruits, and average weight of an individual at a given age. Most

of these formulations estimate the average weight of an individual by incorporating a variation of the widely used von Bertalanffy growth equation.

Yield-per-recruit methods typically require an extensive amount of data on species-specific catch/loss and effort as well as data on the age and size composition of the catch/loss. This additional level of data collection, however, results in more potential flexibility for evaluation of operational and hardware alternatives at power plants and the associated changes in age distribution of losses and magnitude of losses.

### **2.4.2 Age/Cohort-Structured Models**

This class of population-projection models explicitly incorporates age- and/or cohort-specific mortality and reproductive rates. Reproductive rates incorporate the concepts of fecundity, sex ratios, and maturity rates. These models offer advantages over the more simplistic composite models in that the age/cohort-structured models accommodate the variation in mortality and reproductive factors among different age (or size) groups. Ultimately, the goal of such models is to predict effects on population size that may result from some stress, e.g., fishing pressure, power-plant cropping, etc. In terms of this overall goal, the age/cohort structured models are no different from the composite models, described above, or the individual-based models, described in Section 2.4.3 below.

One commonly used device for implementing age/cohort-structured models is the Leslie matrix (Leslie 1945, 1948). This technique incorporates information on mortality and reproduction in a matrix form and manipulations are carried out using matrix algebra. In effect, this is an application of life table analysis, a technique originally developed for human demography (Vaughn and Saila 1976) and that has since been widely applied in wildlife population analyses. The models can be solely density-independent, or can incorporate density-dependent population regulatory mechanisms. The simplest form of the model is the deterministic, linear Leslie matrix. However, there has been considerable recent development of more complex stochastic matrix models (Suter et al. 1993). Examples of the application of the Leslie model in fisheries management and power-plant impact evaluation include Vaughan and Saila (1976), Rago (1980), Vaughan (1981), and Hillborn and Punt (1993). Commercial versions of age- (or stage-) structured models have become available, e.g., RAMAS<sup>®</sup> Environmental Software (Ferson et al. 1991), the development of which was partially funded by EPRI.

#### **2.4.2.1 Matrix Models**

The Leslie matrix (Leslie 1945, 1948) is a commonly used technique for modeling population dynamics in animal populations (Goodyear and Christensen 1984). The basic Leslie matrix model incorporates age-specific abundance, survival probabilities, and average fecundities (Suter et al. 1993). It is essentially an extension of life table

analysis, algebraically manipulated, that provides a convenient method by which discrete time changes in population abundance and age structure may be simulated (Alevras et al. 1980). As discussed below, there are several variants of the technique, i.e., density independent (linear), stochastic, and density dependent. The basic model elements and structure that underpin all model variants are conveniently described by Suter et al. (1993), as follows.

In the linear Leslie matrix, the change in abundance of a population in time can be represented by the matrix equation:

$$N(t) = LN(t-1) \tag{eq. 2-35}$$

where  $N(t)$  and  $N(t-1)$  are vectors representing the number of organisms in each age class and  $L$  is the (Leslie) matrix defined as

$$L = \begin{matrix} & s_0f_1 & s_1f_2 & s_2f_3 \dots \dots s_{k-1}f_k \\ s_0 & 0 & 0 & \dots & 0 \\ 0 & s_1 & 0 & \dots & 0 \\ 0 & 0 & s_2 & \dots & 0 \\ 0 & 0 & 0 & \dots & s_k \end{matrix}$$

where:

$s_k$  = age-specific probability of surviving from one time interval to the next

$f_k$  = average fecundity of an organism of age  $k$

The matrix equation may also be written as:

$$N(t) = L^t N(0) \tag{eq. 2-36}$$

where:

$N(0)$  = age distribution value at time 0

$L^t$  = the matrix  $L$  raised to the power  $t$



According to Leslie (1945), any population growing according to the above equation will converge to a stable age distribution, after which it will grow according to:

$$N(t) = \lambda^t N(0) \quad (\text{eq. 2-37})$$

The term  $\lambda$  is the dominant eigenvalue, or latent root, of the matrix,  $L$ , and is equivalent to the finite rate of population change in the closely related (but non-matrix) reproductive potential models (Suter et al. 1993).

The basic Leslie model described above incorporates the assumption of time invariant (and hence, density-independent) values for age-specific survival and fecundity (Alevras et al. 1980). This implies a linear relationship between stock and recruitment, which has been criticized by some as biologically unrealistic (Alevras et al. 1980, Goodyear and Christensen 1984). However, Alevras et al. (1980) pointed out some specific situations where the linear Leslie matrix has some utility. For example, if a population is exhibiting small fluctuations about some stable equilibrium level, density-dependent responses will not be expected, and the linear (density-independent) model should reasonably approximate real population behavior. Vaughn and Saila (1976) showed that, assuming an equilibrium population, the linear Leslie model can be used to estimate mortality of the zero age class, something that is very difficult to measure directly in the field. Horst (1977) demonstrated that the linear Leslie model may be useful in investigating relative population stability in response to proportional changes in young-of-the-year survival. Although Saila and Lorda (1977) argued that the linear (density-independent) Leslie matrix has value in assessing short-term population fluctuations, Alevras et al. (1980) stated that the model was too constrained, particularly for power-plant impact assessment, and that models which incorporate density-dependent phenomena ("compensatory" mechanisms) are needed for long-term impact assessment.

To increase biological relevance, some researchers have sought to add random variation to the basic Leslie model. This is done by making one or more of the matrix coefficients random variables. For example, the survival rate of newborn organisms may be assumed to be a random variable (Suter et al. 1993). The purpose of such a modification is to better simulate natural population fluctuations as a response to environmental conditions. These "stochastic matrix models" are supported by significant recent theoretical literature. In practical applications, the use of Monte Carlo simulation may be appropriate (Suter et al. 1993). Applications of stochastic matrix models to fish populations have been described by Goodyear and Christensen (1984), Barnthouse et al. (1990), and Ferson et al. (1991).

Investigators have also sought to make matrix models density-dependent, i.e., to make one or more of the matrix coefficients (e.g., age zero mortality) a function of the number of individuals in the population or age class (Suter et al. 1993). This is done to

incorporate the concept of “compensation” or “compensatory response” in the models. As defined by Science Applications, Inc. (1982), compensation is the capacity of a fish population to offset, in whole or in part, reduction in numbers caused by impacts from natural and/or man-made stresses. In response to either high or low densities, it has been documented that mechanisms such as growth, competition, predation, cannibalism, disease, and parasitism act to increase or decrease numbers and tend to act to drive the population to a presumably more stable level. However, the identification and quantification of compensatory mechanisms has been problematic, and the subject of much research. Suter et al. (1993) cited a number of studies involving density-dependent matrix models of fish populations, most directed at power-plant impact assessment. He highlighted uncertainty associated with these models and conjectured that they may not represent improvement over density-independent models. However, others (e.g., Ferson et al. 1991) have made compelling arguments for the utility of density-dependent matrix models.

A summary of method characteristics is provided in Table 2-14. Examples of applications of both the linear (density independent) and combined stochastic and density-independent Leslie matrix models are provided below.

### Application

**Linear (Density-Independent) Leslie Matrix**—Horst (1977) used the linear Leslie matrix to investigate the effects of power-station mortality on population stability of Atlantic silverside, Atlantic menhaden, cunner, and winter flounder. In one exercise, Horst demonstrated the use of eigenvalues of the population projection (Leslie) matrices to evaluate the ability of the populations to withstand perturbations such as power-plant-induced mortality. Horst developed an index,  $I$ , of relative stability of a population. It is calculated as the average deviation of the absolute value of matrix eigenvalues from the absolute value of the maximal eigenvalue (the latter equivalent to the finite rate of population growth,  $R$ ). Since the less  $R$  changes, the less the population changes, and thus  $I$  reflects relative population stability. The index applies only to cases where there is a maximal eigenvalue (excludes one time spawners like silverside), and must be greater than 0.0 and less than 1.0 when the population is at equilibrium. The closer the index is to 0.0, the more stable the population. For the populations of Atlantic menhaden, winter flounder, and cunner evaluated by Horst (1977),  $I$ -indexes were 0.60, 0.46, and 0.21, respectively.

Horst (1977) then constructed a series of matrices and reduced the values of  $s_0$ , the survival of age zero fish, to mimic possible effects of power-plant induced mortality. The results were consistent with the calculation of the original  $I$  indices, i.e., the cunner, with the lowest  $I$  index, showed the least effects of the increased mortality, followed by winter flounder, and Atlantic menhaden. The Atlantic silverside, the shortest-lived of all the species, was most affected by increased mortality in age zero.

Horst (1977) applied the model to explore the theoretical effect of power-plant cropping over time. Using the Leslie model, and setting initial population sizes for all four species at 1 million individuals, he ran the models for a simulation period of 50 years, with introduction of power-plant effects 10 years after initiation. The power-plant effects were represented by an additional age-zero mortality of 10 percent. Following the initial 10 years, the additional mortality was applied for each of 5, 10, 20, and 40 years, after which the simulation was continued until the population reached a new equilibrium size. In all cases, the new equilibrium population sizes following some number of years of additional power-plant mortality were reduced below the original 1 million. Consistent with the results of the *I* indices, the least affected of the species was the cunner, followed by winter flounder, and Atlantic menhaden. The short-lived Atlantic silverside was most affected. The equilibrium population of the cunner after simulation of 40 years of power-plant cropping was approximately half of its original size. Forty-year equilibrium populations of the other species were correspondingly lower, with that of the Atlantic silverside at only a few percent of its original size. In effect, the simulation exercise predicted a “crash” of the silverside population.

Early in Horst’s (1977) paper, he acknowledges the limitation of the density-independent Leslie matrix reflected in its lack of any compensatory mechanisms. As noted in the introduction to this section, compensation in fish populations is an accepted fact, notwithstanding difficulties in quantifying it. Since some species, perhaps many, could compensate to some degree for the additional power-plant cropping in Horst’s examples, his simulations may over-predict impact, and be of limited real-world applicability.

Horst (1977) also provided an excellent example of the importance of life history factors in considering power-plant impacts. He developed a hypothetical case wherein a power plant entrains one million each of winter flounder larvae and menhaden larvae. Based on the *I* indices alone, one might predict less impact to the winter flounder because it has a lower index, and thus would be considered to have greater population stability. However, winter flounder exist in localized populations, with little exchange with neighboring populations. In contrast, the Atlantic menhaden stock is composed of one large interbreeding population throughout its range. Therefore, in this example, although an equal number of larvae of each species are entrained (1 million), a much greater proportion of the flounder population is affected relative to the menhaden. When the entrainment mortality of both species is divided by the projected larvae production for each species to calculate a mortality rate due to entrainment, the results are dramatically different. In Horst’s example, mortality of winter flounder due to entrainment was five orders of magnitude higher than that for menhaden. Although winter flounder may be said to have greater population stability based on *I* indices, and consequently more resistance to power-plant induced mortality, these factors are overridden by the large disparity in apparent population size between the two species.

**Example of Stochastic and Density-Dependent Leslie Model**—Ferson et al. (1991) described the use of the RAMAS<sup>®</sup> Environmental Software to investigate ecological risk to Hudson River striped bass from both fishing and power-plant induced mortality. The RAMAS<sup>®</sup> approach is based on the classical, deterministic Leslie matrix model, enhanced by the inclusion of stochasticity (to better simulate natural variation) and density dependence. Rather than using single values for age-specific fecundity and survival, these are chosen by the researcher from probability distributions. With multiple iterations of the model, this produces the desired stochasticity. Density dependence is the relationship between population size and egg production, and is introduced in RAMAS<sup>®</sup> via either the Ricker or Beverton-Holt functions (see Section 2.4.1.3 of this document), or as a user-specified function. The incorporation of density dependence enables the model to yield equilibrium population projections through time, whereas the original, density-independent Leslie model inevitably led to either population explosion or extinction with time. The RAMAS<sup>®</sup> model yields projections of abundance with time, and probabilities of abundance falling below designated thresholds with time.

The age-structured population model employed by Ferson et al. (1991) is only one of a suite of risk and population models collectively referred to as RAMAS<sup>®</sup> Environmental Software, and marketed by Applied Biomathematics of Setauket, New York. EPRI has provided continuous support and funding for development of the models for more than 15 years, and either owns or co-owns many of the models. A comprehensive description of the RAMAS<sup>®</sup> family of models has recently been published (EPRI 1998).

To evaluate the relative effects of fishing and power-plant cropping on striped bass in the Hudson River, Ferson et al. (1991) used previously parameterized models as a starting point, and included a range of assumptions of the effect of density dependence. These model simulations were run in a baseline condition for a 25-year period to explore background variability, i.e., without the influence of fishing or power plants. Resulting natural fluctuations were determined to be about one-third of average population abundance. The effect of superimposition of several levels of fishing selectivity and mortality were then explored. The fishing scenarios ranged from sport fishing only with a minimum 33-in. size limit and one fish/day creel limit, to combined sport and commercial fishing with a minimum 18-in. size limit and no creel limit. Any level of fishing mortality was found to increase the probability of a population reduction below some specified threshold level (termed “quasi-extinction”). Relative to natural fluctuations, the most conservative fishing scenario (33-in., 1/day) increased population-reduction probabilities only slightly. Substantially greater increases in population-reduction probabilities were projected in the combined sport/commercial fishing scenario. Simulations were then run whereby power-plant induced mortalities to zero age fish were set at 10, 25, and 45 percent of the population, in addition to natural mortality. Predictably, the probability of population reduction increased with increasing mortality of zero age fish. However, even at the 45 percent mortality level,

the projected power-plant impact was not as severe as that projected for two fishing scenarios: either sport and commercial fishing with an 18-in. size limit, or sport-fishing only with an 18-in. size limit. Thus, at low size limits in the fishery, and assuming moderate density dependence, modeled impacts due to fishing were greater than impacts due to power plant cropping. Ferson et al. (1991) concluded that their application of a stochastic, density-dependent model can facilitate comparison of different sources and magnitudes of mortality in fish populations.

*Synopsis*—as indicated in the general description above, use of the Leslie matrix has not been without criticism. Much of that was directed at the lack of realism and flexibility of the deterministic, density-independent Leslie model. More recent applications have addressed the main criticisms by incorporating stochasm or density-dependence or both (e.g., RAMAS<sup>®</sup>). Proper application of the Leslie model also requires life history data that may be difficult and expensive to obtain if it does not already exist (i.e., age-specific fecundities, sex ratios, and mortalities) (Vaughn et al. 1982). It is not an accident that many of the published applications of the Leslie model deal with fish species for which much of the life history data already exist (e.g., Hudson River striped bass). Technical merits aside, if detailed life history data are lacking, investigators may be better served with one of the simpler composite model formulations that require fewer data. Notwithstanding criticisms, the Leslie model has been improved over the last 50 years and is considered a “powerful tool” (Vaughan et al. 1982) in evaluating stress on fish populations.

### **2.4.3 Individual-Based Models**

Individual-based models (IBM) allow evaluation of population dynamics based on tracking the attributes of individual population members (e.g., fish) (Table 2-15). This is in contrast to “state-variable models” (e.g., age-structured cohort models, composite models), which are based on distributions of attributes, or “average individuals.” As pointed out by Huston et al. (1988), the state-variable models violate two basic tenets of biology:

1. They assume that the aggregation of many individuals can be described by a single variable, such as population size
2. They assume that each individual has an equal effect on every other individual

These violations are avoided by basing modeling on attributes of individuals within a population.

Prior to the mid-1980s, individual-based models had been used primarily in the fields of physics, astronomy, botany, and ornithology (Huston et al. 1988). Largely as a result of three review publications (Huston et al. 1988, Lomnicki 1988, and Metz and Diekmann 1986), there has been a recent surge of interest in individual-based modeling techniques.

Following these key publications, EPRI, the Environmental Sciences Division of the Oak Ridge National Laboratory, and the Alliance Center of Excellence of the University of Tennessee co-sponsored a symposium in Knoxville entitled, "Populations, Communities, and Ecosystems: An Individual-Based Perspective." The proceedings of this May 1990 symposium were subsequently published as *Individual-Based Models and Approaches in Ecology* (DeAngelis and Gross 1993). In a similar time frame, a symposium entitled, "Individual-Based Approach to Fish Population Dynamics: Theory, Process Studies, and Modeling Approaches," was held in September 1991 at the Annual Meeting of the American Fisheries Society in San Antonio, Texas. Much of the research presented at this symposium was sponsored by EPRI and was ultimately published as an issue of *Transactions of the American Fisheries Society* (Volume 122[3] 1993).

EPRI's interest in IBM is founded in their program on Compensatory Mechanisms in Fish Populations (CompMech). This program was initiated in 1987 to develop defensible mechanisms for incorporating compensation in models used to predict power-plant impacts on fish. As defined by Science Applications (1982), compensation is the capacity of a fish population to offset, in whole or in part, reduction in numbers caused by impacts from natural and/or man-made stresses. The degree of compensation possible in fish populations was central to the controversial Hudson River power plant case in the early 1980s (Rose et al. 1997). This famous case provided much of the initiative for the CompMech program. Rose et al. (1997) stated that compensation is simulated in the CompMech approach by imposing effects on individuals, which then are translated to the population level.

The CompMech program is a collaborative approach among academic, utility, and resource agency personnel. CompMech comprises two subprograms: Key Species Program and the Fellowship Program. The former has resulted in development of a suite of IBM for fish species covering a range of life history strategies. These can be used directly, or modified for similar species. The Fellowship Program involves EPRI's funding of graduate research on fish population dynamics and individual-based modeling approaches to provide model tuning and development information. EPRI continues to support development and application of individual-based models (e.g., Rose et al. 1997; Dong and DeAngelis 1998).

To ecologists, individual-based modeling approaches are attractive because they are fundamentally more realistic than state-variable models. The state of a population is a function of the collective attributes of each individual member, not the "average" member. As Crowder et al. (1992) stated, "the mechanisms governing survival and recruitment...operate at the level of the individual...interpretations based on modeling the average individual may be misleading." Crowder et al. (1992) cited Sharp (1987) in pointing out that the *average* fish (the typical basis of state-variable models) dies in less than a week, and modeling based on the average fish may not realistically deal with survival and recruitment to a cohort. That is, it is the atypical individuals (e.g., faster

growing) that may constitute the bulk of recruits. These will be realistically accounted for in an individual-based model, but not a state-variable model. IBM also lend themselves well to evaluation of stochasticity and density-dependence in population interactions. These models are said to be the only appropriate approach when dealing with small populations, or in cases where local interactions among individuals are important (Breck 1993). Further, according to Breck (1993), IBM may incorporate bioenergetics and dynamic prey submodels, which can add to the realism of the population modeling. Finally, IBM are “easier to construct, easier to explain and interpret, and easier to parameterize” (Breck 1993), relative to other models. They do, however, require powerful computing resources to keep track of many individual interactions. A summary of individual-based model characteristics is provided in Table 2-15.

Unlike state-variable models such as the Leslie matrix (Section 2.4.2), IBM are not conveniently represented by one or a few compact equations. The latter models can be quite variable, depending on the type of individual attributes incorporated (e.g., growth or size; mortality), and the nature of the submodels. However, DeAngelis and Rose (1992) provided a simple example that illustrates the fundamental difference between a distribution-based (i.e., state-variable) model, and an individual-based model. In a simple, deterministic expression of growth of organisms, the continuous distribution (or state-variable model component) is illustrated in a differential equation as:

$$dS(t)/dt = G_d[S, E(t)] \tag{eq. 2-38}$$

where:

$t$  = time

$S$  = size continuum variable

$G_d$  = growth rate at point  $S$  along the continuum of sizes

$E(t)$  = time-dependent function including all relevant environmental factors

In contrast, the corresponding individual-based model component is:

$$dS_i(t)/dt = G_c[S_i, E(t)] \quad [i = 1, 2, \dots, n(t)] \tag{eq. 2-39}$$

where:

$S_i$  = the growth in size of the  $i$ th individual

$G_c$  = the growth rate of the  $i$ th individual as a function of its current size ( $S_i$ )

$n(t)$  = the total number of individuals

Although conceptually simpler than state-variable models, the IBM require a much greater amount of data, and thus greater computing power. Based on Huston et al. (1988), the development of IBM, and the development of more powerful computers necessary to run the models, have essentially been parallel processes over the last 20 years.

### **Application**

As recently as six years ago, IBM were said to be developmental and theoretical. As stated by Gross et al. (1992), "...it appears that at present we are still focused mainly on understanding process, rather than developing predictive capacity." These authors stated that few actual applications of IBM had been made in a resource management context. This is changing, however, as exemplified by the work of Sutton (1997). The author, an EPRI CompMech Fellow, focused his dissertation research on the relationship between stocking rates and adult stocks of striped bass in Virginia's Smith Mountain Lake. Application of CompMech's (IBM) striped bass model identified changes in stocking size and timing that predicted a doubling of first-year survival. Based on these results, the Virginia Department of Game and Inland Fish initiated changes in stocking strategy and committed to a \$2 million state-of-the-art hatchery.

Other examples of research on IBM that could have positive impacts on resource management are found in Winemiller and Rose (1992), Jager et al. (1993), Van Winkle et al. (1993a, 1993b), and Clark and Rose (1997). EPRI (1996) summarized a number of applications of IBM to resource evaluation and management, including power-plant impacts.

Provided below are two examples of the use of IBM to analyze fish populations.

#### **Lake Michigan Bloater Population (Crowder et al. 1992)**

Crowder et al. (1992) reviewed a decade of research on recruitment mechanisms in the Lake Michigan bloater (*Coregonus hoyi*). The overview included a particularly concise description of the evolution of population modeling, and the importance of recruitment. The authors provided examples from their research on bloaters that support the individual-based modeling concept.

In seeking to determine the important factor(s) affecting recruitment of bloater, the authors investigated typical mechanisms controlling recruitment in marine fishes, i.e., starvation, physical environment (e.g., transport), and predation. Also, by examining otoliths, they determined birth date, growth rate, and stress periods. They found that



growth rate was important to survival and recruitment. Larvae that hatched later grew faster and had greater survival than those that hatched earlier. Through laboratory studies and otolith examination, they also were able to rule out starvation and stress as significant factors. Thus, recruitment success was related to size or growth dependent mortality. Additional experiments confirmed that predation on young bloater by the planktivorous alewife (*Alosa pseudoharengus*) was important, and highly size-dependent. The probability of capture of larvae decreased with increasing size of larvae. Also, predation on zooplankton by alewife can indirectly affect bloater larvae by reducing their food supply and slowing their growth. Physical factors, particularly low temperature, can also slow the growth of bloater larvae, thus extending their period of vulnerability to predation.

Based on their studies, Crowder et al. (1992) drew strong conclusions regarding the importance of the individual organism in recruitment, in contrast to the average individual. They stated that "...survivors tend to be atypical rather than average individuals." The authors related their interest in individual-based modeling to their studies of recruitment in fish by stating:

It is *individuals* that survive to recruit; the unique characteristics of individuals, and not population averages, determine which individuals survive. Individual-based models are not only interesting, but are perhaps the only logical way to model these processes.

Based on their research, the authors constructed a conceptual model for larval and juvenile fish recruitment. The various steps of the model all have a time-dependent component, and include such factors as prey encounter and feeding, growth, starvation, predator encounter rate, and probability of capture. They explored the predation component of the model for alewife predation on bloater larvae and juveniles. They simulated the growth and survival of individual bloater larvae over the first 60 days of life (Luecke et al. 1990), and discovered that higher survival was related to higher variance in growth rates, because selection for faster growing (larger) fish increased. When variance in growth rate was high, almost all survivors were from the upper 25 percent of the initial growth rate distribution. This reinforces the point made above regarding the fact that "average" fish do not survive to recruit.

In summarizing, Crowder et al. (1992) reflected on the appropriateness of model types. If, at a given level of aggregation, the average individual can be considered representative, then the better known state-variable models may be used (e.g., Leslie matrix). However, if behavior, physiology, or other characteristics vary importantly among individuals, then an individual-based model would be most appropriate.

### Potomac River Striped Bass (Rose and Cowan 1993; Cowan et al. 1993)

These two companion papers were published in the individual-based model symposium collection published in the *Transactions of the American Fisheries Society* (May 1993). The first provided model description, results, and corroboration for first year striped bass. The second paper used the model to explore the effects on year-class strength of annual variations in biotic and abiotic factors. Both of these studies form part of the documentation that supports EPRI's "key species" model for striped bass (Rose et al. 1997).

Rose and Cowan (1993) constructed a detailed model that followed the individual progeny of 50 female striped bass in the Potomac River. The growth and mortality of the progeny were simulated as they moved through the egg, yolk-sac larvae, feeding larvae, and juvenile stages within a well-mixed, 4 million M<sup>3</sup> compartment of the river. Daily temperature, fraction of day as daylight, and spawning temperature were input to the model. Development and mortality of eggs and yolk-sac larvae were temperature dependent, and an additional mortality constant was added to temperature to make mortality in the model reflect field observations. The growth of larvae and juveniles in the model is driven by the following bioenergetics submodel:

$$W_t = W_{t-1} + p * C_{max} * A - R_{tot} \quad (\text{eq. 2-40})$$

where:

$t$  = day

$W_t$  = daily growth in dry weight (mg)

$C_{max}$  = maximum dry-weight consumption rate (mg/d)

$p$  = proportion of  $C_{max}$  realized

$A$  = utilization efficiency

$R_{tot}$  = total dry-weight metabolic rate (mg/d)

Calculation of  $p$  involves an intricate accounting of feeding of the fish, and includes such components as prey encounters, prey selection, prey turnover rates, and prey consumption. According to Rose and Cowan (1993) the calculation of  $p$  accounts for the bulk of the computations in the model. The assignment of mortality to larvae and juveniles has both a weight and a length component. The weight component reflects the probability of mortality due to starvation, and the length component reflects predation mortality. The latter is highly size-dependent, consistent with what has been demonstrated for bloater by Crowder et al. (1992).

The authors used the relatively extensive field database for striped bass in the Potomac River to corroborate their model. In general, the model predictions were within the ranges of field data for egg, larvae, and juvenile densities; growth rates; and mortality rates.

The key factors leading to greater survival were female size and growth rate immediately after first feeding. The larger females produced more and larger eggs, which led to greater length at first feeding.

In summarizing and discussing their model, Rose and Cowan (1993) compared their approach to previous constructions of IBM of fish population dynamics. Their model was much more detailed in terms of simulation of multiple lifestages, a temporally varying environment, and multiple prey types. Prey dynamics were particularly detailed; consequently, the model was “data hungry” with regard to striped bass feeding data. Notwithstanding the more detailed nature of their model, particularly with regard to feeding dynamics, the authors point out that there are variables other than feeding that affect recruitment, and consequently, their model must overall be considered relatively simple. In its present form, the model was said to be more descriptive than predictive. The authors concluded that without further refinement and corroboration, the prediction of year-class strength in the Potomac River was not possible.

Some refinement was presented by Cowan et al. (1993), who used the baseline model of Rose and Cowan (1993) to test the hypothesis that high variability in the Maryland Department of Natural Resource’s (MDNR) striped bass recruitment index can be explained by small changes in larval growth and mortality rates during the nursery periods in major spawning tributaries. The authors conducted simulations that varied (individually and in various combinations) four recruitment factors: 1) size of female spawners, 2) zooplankton prey density, 3) density of competing white perch larvae, and 4) water temperature during the spawning/nursery period. Simulations were run for a period of one year.

Some effects on recruitment were observed with all four factors, but female spawner size had the largest single effect. Larger females produced a greater number of eggs, from which hatched (feeding) larvae that grew faster, and this resulted in a higher survival rate, relative to that experienced by progeny of smaller spawning females. Simulation of higher densities of zooplankton was associated with higher survival of striped bass larvae. Density of competing white perch larvae had only a minor effect on the simulations. Water temperature effects were complex, and possibly interactive with female spawner size. Using variations in the recruitment factor results to simulate striped bass indices for the Potomac River, the authors could not duplicate the natural level of variability (MDNR recruitment indices measured for the Potomac River can vary by 145-fold). However, when combinations of the four recruitment factors were tested, simulated Potomac River indices were similar to measured indices for the

Potomac River. Cowen et al. (1993) concluded that their individual-based model simulation study suggests that small changes in larval growth and mortality can explain the high variability in the striped bass recruitment index for the Potomac River. Further, it is very likely that the combined actions of two or more recruitment factors are necessary to produce large changes in growth, mortality, and other vital rates of young striped bass that would result in exceptionally high or low recruitment to the one-year age class.

**Synopsis**—The above-described attributes of IBM support the applicability of the approach in power-plant impact assessment. In particular, the explicit and implicit incorporation of compensation, or density-dependence, in the models is critical to credible evaluation of power-plant impacts. However, the development and application of site-specific IBM to assess power-plant impacts is labor-, expertise-, and cost-intensive, and requires a relatively great amount of life history and physiological data. EPRI's CompMech approach (Rose et al. 1997) suggests a stepwise, or phased approach to site-specific power-plant impact assessment. In early phases, hydrodynamic simulations (Section 2.3.4 this document) and age or stage-structured models (Section 2.4.2 this document) may be used to define and screen the potential impact. If then warranted (i.e., there is potential for serious impact to one or more species), the implementation of a site-specific, individual-based model may be considered.

## **2.5 Ecosystem/Community Models**

Although it is broadly believed that the goal of the Clean Water Act should be protection of the ecosystem/community (not just individual populations), most power plant studies have either focused on estimation of impacts on selected target or representative species populations or have been limited to retrospective evaluations of various biological diversity-type metrics (see Section 3.2) and multivariate analyses (see Section 3.5) (LMS 1980b). Few impact assessment studies have been specifically designed to directly and quantitatively evaluate or predict the effects of power plant operation on the interactive trophic dynamics and production at the aquatic ecosystem/community level. This clearly has been a function of the significant increase in the perceived amount of data needed, complexity of the analyses, and assumptions necessary (Table 2-16) to move from the population level to the ecosystem/community level, as well as the computational hardware and software available to the majority of ecologists and environmental scientists (Suter and Bartell 1993). Ecosystem models have been constructed to examine a wide array of questions related to the functioning of most types of aquatic ecosystems including physical, chemical, and biotic features, nutrient and contaminant cycling, bioenergetics, and productivity. However, while considerable theoretical research and development, and philosophical opinion and discussion, have been directed at food web theory, ecosystem dynamics, bioenergetics, and biomathematical representation of ecosystem function (Levin 1974, Hall and Day

1977, DeAngelis et al. 1982), few site-specific, predictive ecosystem simulation models have been developed and adequately documented for the purpose of impact assessment at power plants (LMS 1980b, Pikitch et al. 1978). However, where sufficient data are available, ecosystem simulation models may be a valuable tool for the integration of a wide range of data and information about a system and for hypothetical evaluation and testing of system relationships and behavior. The pros and cons of ecosystem/community models versus population models were highlighted in the Fifth National Workshop on Entrainment and Impingement in 1980. The points made in the two position papers and the moderator's summary are still valid (Leggett 1981, McKellar and Smith 1981, and Van Winkle 1981).

Ecosystem simulation models applicable to impact assessment are inherently site-specific and not readily transferred and adapted between sites. Thus, unlike many of the other impact assessment techniques discussed in this document, there are no standard models that can be "taken off the shelf" and run by a knowledgeable person for any other site. Even a calibrated, validated, and tested model from a site will require careful review and modification before it can be used at another similar location.

Most criticisms of population assessment methods typically have targeted the validity and reliability of the underlying assumptions that must be made in order to construct various simulation models. The available scientific information on life history dynamics is often limited or non-existent for many species with the exception of a relative few which have been the target of major commercial and/or recreational fisheries or specific impact studies and thus the subject of considerable study. The cost to collect such information over a significant number of years for a single species from field or laboratory studies can be considerable. In addition, the data management and computational capabilities to analyze such data can be considerable. In the absence of such information and funding, "best professional judgement" of the scientist or technical workgroups plays an important role in defining reasonable input parameters and assumptions. Achieving agreement on these decisions among various parties performing and reviewing an impact assessment can be time and resource consuming. Moving up a level in complexity from population to community analysis typically amplifies most of these same issues.

At the ecosystem/community level the amount of available quantitative data is often more limited and our understanding of the complex inter- and intra-specific interactions and competition is often rudimentary. This is not to say that ecosystem/community models do not provide a valuable tool in an overall power plant assessment strategy. As long term data become more common at older power plant sites or through resource agency monitoring programs, ecosystem/community-based assessment approaches have become more feasible. Furthermore, the development and availability of faster desktop computers and advanced data management and modeling software have provided valuable tools which enable construction and use of more

complex models by a wider range of scientific practitioners. As with population models, carefully constructed and documented ecosystem/community models may provide valuable insight into the interaction of power plant operations with the biotic system and the ecological risks associated with power plant operations. In addition, they can be a useful tool for evaluation of proposed power plant operating and hardware alternatives, facility siting options, and mitigation alternatives (Dale and Van Winkle 1998; Kemp 1981; Hall and Day 1977).

As with population models, it is typically necessary to make some simplifying assumptions about the trophic interactions of a given food web in order to focus on key ecosystem components and pathways to construct an appropriate conceptual model which encompasses the potential community impacts and issues. This requires a balance between reductionist models which incorporate extensive detail to describe intricate food web interactions, and holistic models which utilize considerable aggregation to facilitate simulation of trophic energy transfer (Kemp 1981; Botkin 1975; Laine et al. 1975). Laine et al. (1975) proposed the application of niche theory as a basis of simplification/reduction of input parameters to focus ecosystem analyses; the Oak Ridge Systems Ecology Group (1975) described this as a functional approach to dynamic ecosystem modeling. Another important simplifying decision which needs to be addressed early in the modeling process is the often arbitrary selection of reasonable physical boundaries for the ecosystem and treatment of trans-boundary processes (Pikitch et al. 1978).

An approach to developing a workable conceptual ecosystem model is described as part of the problem formulation phase of U.S. EPA's ecological risk assessment framework (Bartell et al. 1992, U.S. EPA 1996a, 1997a, and 1998a, Suter et al. 1993, Suter and Bartell 1993). This process typically involves defining the management goals, assessment endpoints, and measurement endpoints; development of a set of hypotheses to describe the key predicted relationships among stressors, exposure, and assessment end point response and a rationale for selection of endpoint; illustration of the relationships in the risk hypothesis in diagrammatic form; identification and evaluation of applicable, available data and new data requirements; and identification of sources and magnitude of variability and uncertainty.

LMS (1980b) provides a concise summary (adapted from Orlob 1975) of a 10-step process necessary to create a credible and reliable ecosystem simulation model which can form the basis for decision-making in the impact assessment process (Figure 2-4). Briefly these steps are:

1. Conceptualization—Setting the objectives of the modeling effort; describing the system and relationships among components; and determining available information on the system.

2. Functional representation—Specific description of the model system including boundaries, system parameters, system input and output, spatial and temporal scaling, and formulation of interactional mechanisms.
3. System solution—Selection of the numerical algorithms and other techniques to express the functional representation of the system for computation of various intermediate and final output values.
4. Computational representation—Selection and development of hardware and software tools and implementation of the computational structure of the model program.
5. Model validation—This step includes the processes of program debugging and testing the acceptability of the working model relative to “known” solutions of similar systems.
6. Calibration—This is the process of tuning the model by adjusting selected input parameters using subsets of data from the site to attain “reasonable/acceptable” agreement between model projections and the measured field or laboratory observations associated with the parameter conditions.
7. Verification—Testing the model’s ability to reasonably predict system characteristics of interest based on data subset independent of that used for calibration.
8. Final sensitivity analysis—Evaluation of the model’s response during a set of controlled changes to the range of selected input variables and model parameters.
9. Documentation—A clear description and summarization of the basis for all the previous eight steps including a detailed description of the model and its development; development of a users manual with all data and information necessary for an independent party to duplicate the process; and a system manual providing the program details.
10. Application—Use of the validated, calibrated, and verified model to make projections related to the goals and objectives for which it was created.

There can be considerable overlap in the scope and sequence of these steps for any given modeling effort and the process typically entails feedback and recycling within and between these steps. Hall and Day (1977) represent these steps and feedback processes diagrammatically (Figure 2-5) and present detailed information on the process of constructing a conceptual/mathematical ecosystem model.

In their review of ecosystem modeling, LMS (1980b) expressed a relatively negative view of the usefulness of ecosystem modeling techniques in power plant impact assessment for the near future. This was based in part on the considerable expense and

effort required to produce credible models and the difficulty in separating individual power plant effects from cumulative impacts of man on the ecosystem. They also point out the skepticism that most ecosystem models have met with when applied as predictive tools for impact assessment, particularly in adversarial proceedings (see also MacBeth 1977). The primary reason for this skepticism is the dearth of “well-described and well-verified and validated models in the open scientific literature...many good models remain undocumented and many well-documented models have poor predictive capability.”

Two recent position papers in the *Bulletin of the Ecological Society of America* (Aber 1997; Dale and Van Winkle 1998) indicate that the promise of ecosystem modeling as a reliable, credible tool for quantitative impact assessment is as yet unrealized, in that little progress has been made in the 18 years since the LMS review in 1980 toward improving the general acceptance of ecosystem modeling for impact assessment among the scientific, regulatory, and legal communities; this, in spite of enhancement of computational capabilities presented by advances in computer technology and software/programming tools.

Aber (1997) bemoans the lack of “belief” or acceptance of ecological modeling “as a serious tool, like statistics, for example, that most ecologists use as a regular part of their work, despite the constant acknowledgment that we deal with complex and highly interactive systems, and that quantitative understanding and prediction are critical.” He proposes that a consistent application and presentation by modelers of the same steps and information called for by LMS (1980b) and Pikitch et al. (1978) would go a long way toward dispelling this skepticism.

Responding to Aber (1997), Dale and Van Winkle (1998) take a more positive perspective citing many of the benefits of simulation modeling emphasized by Hall and Day (1977). They emphasize that the primary value of a simulation model is to increase understanding and gain insight into the system. As part of an impact assessment, Dale and Van Winkle see models serving two roles as tools to aid decision makers: 1) “Where the field, laboratory, and environmental data are not available, not appropriate, or not directly applicable to the decision being made...results of simulation models can provide valuable perspective on alternative decisions”; 2) “When extensive data are available, the complexity of the situation may require a model for interpreting interactions or expanding to larger spatial scales, longer time scales or higher levels of biological organization.” They see the process of developing a simulation model as one that is “integrative, interactive, and iterative”; this is a collaborative process that may require the involvement of groups of scientists, regulators, and lawyers. In addition to echoing the LMS and Aber calls for standardization and consistency in development and presentation of models, Dale and Van Winkle emphasize that the models do not need to strive to perfectly mimic the system. In subsequent commentary, Aber (1998) and Van Winkle and Dale (1998) agree on several important aspects of ecosystem modeling including the need to precisely define terms and steps in the modeling



process and the importance that all parties to a modeling exercise have clear and realistic expectations from the start as to what the model can accomplish in terms of understanding of ecosystem processes, and accuracy and precision of predictions. Rather, a minimalist approach is proposed which “ includes the least amount of data that *adequately* explains the phenomena of interest.” They attribute the reservations of many scientists and decision-makers to unrealistic expectations of the capability of models. Models provide projections of possible results under a scenario of specified conditions which are only as good as the assumptions upon which the model is based. As Holling (1996) phrased it, “there is an inherent unknowability, as well as unpredictability, concerning ecosystems and the societies with which they are linked.” Thus in addition to the need for sensitivity analysis, Dale and Van Winkle also highlight the need for uncertainty analysis to clearly identify the sources of uncertainty, their potential effect on the model results, and the limits of the model’s applicability. Recognizing these factors, decisions generally should not be based solely on the results of model simulations, but on an understanding gained from the application of multiple analytical tools to optimize our understanding of the system with the available information (Hall and Day 1977).

Ultimately, the potential value of ecosystem/community modeling must be decided on a case by case basis. Typically the construction, calibration, and validation of an ecosystem simulation model is a site-specific process; that is, most simulation models constructed for a particular application cannot readily be transferred from one site to another. Considering the existing knowledge of the system to be studied, the empirical data and resources available, and the level of controversy/cooperation of the parties involved, a critical evaluation of the relative strengths of ecosystem/community modeling versus other assessment techniques should be made to determine which techniques are most appropriate. Ecosystem/community models are simply one level in a hierarchy of assessment tools that may be more or less essential to a given assessment, depending on the circumstances and objectives of the assessment (Suter and Bartell 1993). Where ecosystem/community modeling is selected as a component of an overall impact assessment, the model should incorporate sufficient flexibility to allow it to be readily modified and upgraded as understanding of the system increases.

Of the wide variety of ecosystem/community models which have been developed, Bartell et al. (1992) conclude that for risk assessment applications, process-oriented bioenergetics models of aquatic production dynamics are most often utilized. This is a consequence of considerable research invested in these types of model and their successful application to a variety of aquatic systems; and these models make predictions at levels of biological organization of direct interest to decision makers. Vaughan et al. (1982) reviewed fish bioenergetics/growth models as tools for assessment of multiple stresses, but not specifically power-plant-related effects. However, these emerging models are not without controversy, related to their reliability and accuracy in using laboratory and field data to describe growth, dynamics, and species interactions (Hansen et al. 1993).

Two broad classes of ecosystem/community models which have been used by electric utilities are discussed below. The first includes simple trophic models which project the transfer of biomass, production, or energy through a food chain. Trophic levels or groups of functionally similar species are aggregated in compartments. Relationships among trophic levels are represented by simple proportionate transfer mechanisms. This is described as a “black box” model by Pikitch et al. (1978), where interactions between organisms are ignored and interactions between compartment flows are based on the level of the modeler’s knowledge of the system. The second class of ecosystem/community models are more complex, addressing the interactions and associations among populations and expressing biotic and abiotic relationships using mechanistic mathematical equations. In some cases the equations simply express a mathematical relationship observed in empirical data; in others they attempt to simulate known or hypothesized causal relationships or bioenergetic processes. The more individual populations represented in a model, the more data required to construct the model, and the more assumptions likely to be required. The structure of some models may be a hybrid of these two general classes, that is, some selected populations are treated individually while other trophic levels and populations within the trophic level are aggregated. Several other dichotomies are seen in the available approaches to ecosystem modeling: model formulations can be linear or non-linear, short or long term in scale, deterministic or stochastic. The most appropriate approach will depend on the modeling objectives and available information at any given site.

### **2.5.1 Food Chain Production Projections**

In the most simple ecosystem approach, estimated biomass (production) forgone of a particular species as a result of power plant operations can be extrapolated through a foodchain representative of the source/receiving waterbody to predict the biomass forgone within other components of the food chain. Losses can be projected at several trophic levels in order to adequately represent direct power-plant-related losses associated with factors such as entrainment, impingement, or ecotoxicity. Indirect food chain effects (effects at one level which are predicted as a result of biomass losses at another level) are estimated based upon generic trophic transfer coefficients or data for the specific species in the model. Production can be projected up or down the food chain using such models.

One example of such an application is an aggregated food chain model developed to estimate saltmarsh productivity and the acreage equivalent to the biomass forgone as a result of entrainment and impingement losses at the Salem Nuclear Generating Station (PSE&G 1994, 1993a, 1993b). The model was constructed by a team of fisheries and wetland scientists working in consultation with regulatory staff scientists from New Jersey Department of Environmental Protection for the purpose of estimating the number of acres of wetland restoration which would enhance primary production and associated production at higher trophic levels of the lower Delaware River estuary

ecosystem in order to offset power-plant-related losses. The conceptual model consisted of a simple linear food chain aggregated at five trophic levels from primary producers to third level consumers representative of the target species of the long-term impact assessment studies at the site (Figure 2-6). Productivity rates and intertrophic conversion rates were selected based on extensive review of the scientific literature; extensive long-term biological data collected by PSE&G and resource agencies in New Jersey and Delaware provided information on trophic structure, and food habits and relative utilization of various habitat by target species. Various remote sensing and aerial mapping were used to estimate the relative amount of various tidal and non-tidal wetlands habitat in the lower estuary. This model and the supporting technical information were an integral part of the negotiations between PSE&G and regulatory agencies in the states of New Jersey and Delaware and regional EPA, and became the primary technical basis for key Special Conditions and monitoring provisions of the final NJPDES Permit for the Salem Station following public review and comment.

### ***2.5.2 Community/Ecosystem Models***

This class of models includes those which integrate a wide array of components of a community or ecosystem. These models typically incorporate multiple trophic levels, predator-prey relationships, and physical and chemical parameters. They focus on energy or biomass flow through the ecosystem. An overview of this approach with respect to power plant impact assessment is provided in McKellar and Smith (1981), and examples of use include Kemp (1981) and Kaluzny et al. (1983). Hall and Day (1977) present a series of papers which describe the process of constructing such a model and several case studies of simulation model applications to various resource management and impact assessment. Some of their examples include incorporation of economic and societal valuation factors into the models for system optimization assessments.

A series of scientific papers and utility reports describe an ecosystem simulation model developed to assess the relative cost-benefit of power plant operations, expansion, and cooling tower construction and operation at Florida Power Corporation's Crystal River Power Plants (Odum 1974; Kemp et al. 1977; Kemp 1981). Kemp (1981) indicates that the model is an extension of a developing methodology, "to allow industrial, social, and environmental costs and benefits to be estimated in terms of associated energy flows." While the model integrates an economic aspect, it is not an economics-, but an energetics-based model and Kemp warns that, "Economic and energetic analyses provide different information to decision makers and are, thus, not substitutes for one another...they can be expected to provide only a partial accounting of the true resource values." The ultimate model synthesizes an extensive database related to power plant effects of the coastal estuarine environment of the Crystal River Power Plant "into a framework in which they can be compared as equivalent losses of photosynthetic energy flow." The overall conceptual model integrates energy flows within the coastal

ecosystem and those associated with power plant operation (Figure 2-7). The validated model is used to compare energy losses associated with specific power-plant-related impacts “to the energy cost of mitigating them with technological measures such as cooling towers.”

Within the model various power plant effects (including entrainment, impingement, and thermal plume) are converted and expressed in equivalent energy terms (that is, equivalent loss of photosynthetic energy); energy costs such as fuel and auxiliary electricity for various power plant operating scenarios are integrated into the model. The basis for this type of ecosystem model is the principle that organisms/systems that best optimize energy utilization are at a competitive advantage in sustaining their continued existence; that is, survival, vitality, and general well-being. It is assumed that, “Any action which disrupts a system’s productive processes is viewed as having a negative effect on that system.” In an early version of the Crystal River estuary model, Odum (1974) constructed an energy circuit diagram to represent the conceptual model where energy from fossil fuel consumption is dissipated, in part, as energy released into the estuary via the thermal plume and is related to other energy sources and sinks in the estuary. In order to equate energy from consumption of fossil fuel and that from photosynthesis, the model makes an educated estimate, “that coal contains on the order of 15-20 times as much embodied energy as direct photosynthesis.” Extensive field studies have been conducted at the site targeted to provide information on the characteristics of the ecosystem, food chain, and particularly seasonal patterns of community metabolism. With ongoing data collection programs, the model complexity evolved incorporating a hierarchical structure of scale (Figure 2-8) from the power plant regional scale, to the estuary, to the outer bay area adjacent to the Crystal River Plant intakes and discharges (Kemp et al. 1977). The branched food web was simplified to a linear chain by partitioning flows for each population according to the distance (number of trophic feeding steps) from primary producers (Figure 2-9). Losses at various lifestages of target species were equated to losses of adult fish sold at market. Energy values were converted to units of work within the system, examining the regional balance between natural and fossil fuel based energies. Various operating conditions were assessed in terms of lost work and its relative environmental and societal costs. The model formulations are a series of simultaneous, non-linear, first-order, ordinary differential equations. Extensive documentation for these equations is presented by Kemp et al. (1977).

Illinois Natural History Survey (INHS 1979a) developed an ecosystem model for a power plant cooling lake under contract to EPRI (EPRI EA-1148) which examined thermal discharge-related effects. Mathematical formulations were constructed to simulate temperature and flow of the physical system (TEMP model) and the biological Cooling Lake Ecosystem Model (CLEM) for Lake Sangchris. The modeling effort was supported by an extensive monitoring program supported by Commonwealth Edison Company on Lake Sangchris and nearby unheated Lake Shelbyville. In addition to calibration, validation, and documentation of the model, a companion report (INHS

1979b) provides summaries of similar monitoring on several other cooling impoundments which provide further support for the credibility of CLEM. The model was constructed with sufficient flexibility to be applicable to a variety of cooling lake situations, but with specificity incorporated by way of site-specific parameter modifications to be useful for site-specific predictive simulations. TEMP was validated with 1975 data and exhibited good agreement with the empirical data; sensitivity analysis demonstrated considerable influence of incident solar radiation and negligible effects of precipitation on model output. CLEM is composed of submodels for phosphorus, detritus, phytoplankton, periphyton, macrophytes, zooplankton, benthos, and fish; these submodels describe mass transfer among components and fish abundance. Five fish populations were described in terms of eight age classes (from egg to adult) and primary life history characteristics (e.g., food habits, spawning, management limits, predation, fishing and natural mortality) were described as functions of length whenever possible. The model was designed as a tool to assess climatological effects, fisheries management strategies (e.g., size and catch limits), and power plant effects on the dynamics of the fish populations. The authors cite as a major limitation to the model, the physical constraints of the programming software utilized at the time (CSMP III--Continuous System Modeling Program).

Polgar et al. (1981) utilizes the results from hydrodynamic population modeling for the Morgantown Steam Electric Generating Station on the Potomac River (see Section 2.3.4) in an ecosystem submodel to assess community level impacts from cooling system effects (Figure 2-10). The model is used to estimate changes at the ecosystem level as a fraction of the system's usable net primary production that would go unutilized if some portion of a lifestage population were eliminated as a result of power plant cooling system operations. The feeding patterns of the individual target species lifestages of the Potomac ecosystem, the distributions of the lifestages over the Potomac trophic structure, and their assimilation efficiencies are the key quantities for determining the fractional intakes of equivalent system net primary productivity by each lifestage. Application of power-plant-related, population lifestage losses to these calculations gives an estimate of the fractional loss of net productivity due to power plant effects.

Under a contract with the U.S. Nuclear Regulatory Commission, Kaluzny et al. (1983) developed a multi-trophic level ecosystem model (LAKONT) to simulate energy flow and population dynamics of Lake Ontario in the vicinity of the Nine-Mile Point and James A. Fitzpatrick nuclear generating stations. The model was constructed using equations from various literature sources to represent system processes; one objective of the program was to evaluate how the model responded using alternative valid equation forms from the literature for specific processes. The model was spatially compartmentalized as a compromise between an assumption of spatial homogeneity or coupling with a fine scale hydrodynamic model. The model simulates populations of multiple species or taxonomic groupings of fish, benthos, zooplankton, and phytoplankton. The biological portion of the model utilizes the dynamic pool concept, following population recruitment among fixed size classes rather than tracking

individual cohorts. All modeled biological processes are combined to simulate changes in weight and number/density of organisms in each size class over time; numbers are influenced by natural mortality and predation mortality while weight is affected by consumption and metabolism. Forcing variables include nutrient concentrations and water temperature. The model is written in AEGIS (Aquatic Ecosystem General Impact Simulator), a language developed at the University of Washington Center for Quantitative Sciences specifically to facilitate switching equation forms within the model. Power plant effects incorporated into the model include entrainment, impingement, and indirect temperature effects on metabolism, food ration, respiration, and primary production.

Haven and Ginn (1978) described general environmental assessment methodology developed by Tetra Tech under contract with EPRI which included five component submodels: a hydrodynamic model, a water quality and ecosystem model, population dynamics models, a planning and system optimization model, and a power plant impact assessment model. The ecosystem model serves as the central integration and impact assessment tool for evaluating thermal chemical and cooling system effects. The assessment sub-component models through plant and nearfield effects of power plant operation including submodels for cooling system characterization, the intake (impingement), plant passage (thermal, mechanical, and chemical effects), and the discharge plume. The generic model was developed using available information from a number of sites, but the individual submodels are constructed to be modified with site-specific data. Such local information includes data for phytoplankton, zooplankton, ichthyoplankton, and fish distribution, abundance, and behavior; organism and population growth rates; impingement and entrainment mortality; population dynamics; intake and cooling system design, technology, and operation; and discharge plume dynamics.

ECOIMP is a model described by Logan and Kleinstreuer (1981) that uses population dynamics and community interactions (predator-prey associations) to estimate impingement losses for a power plant sited on a reservoir. This model uses what is described as a lumped parameter matrix (LPM) which integrates survival probabilities from an age-structured Leslie matrix (Section 3.4.2) with predicted natural oscillatory behavior associated with predator-prey systems from classical Lotka-Volterra equations. The three-dimensional matrix incorporates multispecies interactions into the two-dimensional Leslie matrix and assumes no compensatory survival. The impingement model uses simplified hydrological equations, reservoir fish distribution, intake velocity field, and fish swimming capacity modified by swimming duration and temperature. Eight species were used to describe the ecosystem of Dardanelle Reservoir exposed to Arkansas Nuclear One Station. The population LPM and impingement models were combined for the impingement simulation model in the algorithm summarized in Figure 2-11. Agreement between the model projections over four years and actual impingement varied among the species tested. The authors suggest that overestimates of impingement resulted from underestimates of swimming

capacity of selected species and underestimates of impingement resulted from underestimates of fish density from the reservoir sampling program; lack of compensatory mechanisms also affect model accuracy.

Summers (1989) describes the Patuxent Estuarine Trophic Model (PETS) developed with funding support from the Maryland Power Plant Research Program (PPRP) to evaluate the potential indirect effects on predator biomass associated with reduction of forage fish populations as a result of entrainment losses at the Chalk Point Steam Electric Station. The PETS model describes the average steady-state annual condition of predator and prey populations when a significant number of juvenile recruits are lost to the forage fish population. Indirect losses to the predator populations are in the form of lost production or growth, that is, a reduction in biomass of the predator population rather than in abundance. The model used data collected between 1975 and 1980 to characterize densities and seasonal abundance of the selected populations, and forcing functions (annual biomass cycles of phytoplankton, zooplankton, and benthos, seasonal water temperature cycle, and detrital carbon). Summers characterized the data upon which PETS was based as, "scarce [but] incorporating all known information concerning dietary preference of upper-trophic level fish species in the Patuxent River estuary." Indirect effects were modeled for four top predators (striped bass, weakfish, bluefish, and white perch) in the system (Figure 2-12). Direct effects of entrainment losses on recruitment of forage fish was incorporated for five forage groups (naked goby, bay anchovy, silversides, menhaden, and other forage fish). Densities of fish populations were characterized as a function of trophic transfer (predator-prey interaction), recruitment, natural mortality, respiration, egestion, excretion, and reproduction. Two feeding scenarios and three rates of recruitment reduction associated with entrainment were simulated. In the one feeding scenario, feeding by predators was proportional to prey abundance; the second scenario was based on limited information available on feeding preferences of predator species in the Patuxent and other estuaries. Summers concludes that, but for a lack of necessary information, "a more mechanistic model which includes migratory phenomena, search and capture energetics, prey switching algorithms, and feedback mechanisms between the forage populations and their prey would more clearly address the long-term indirect consequences of forage fish entrainment losses."

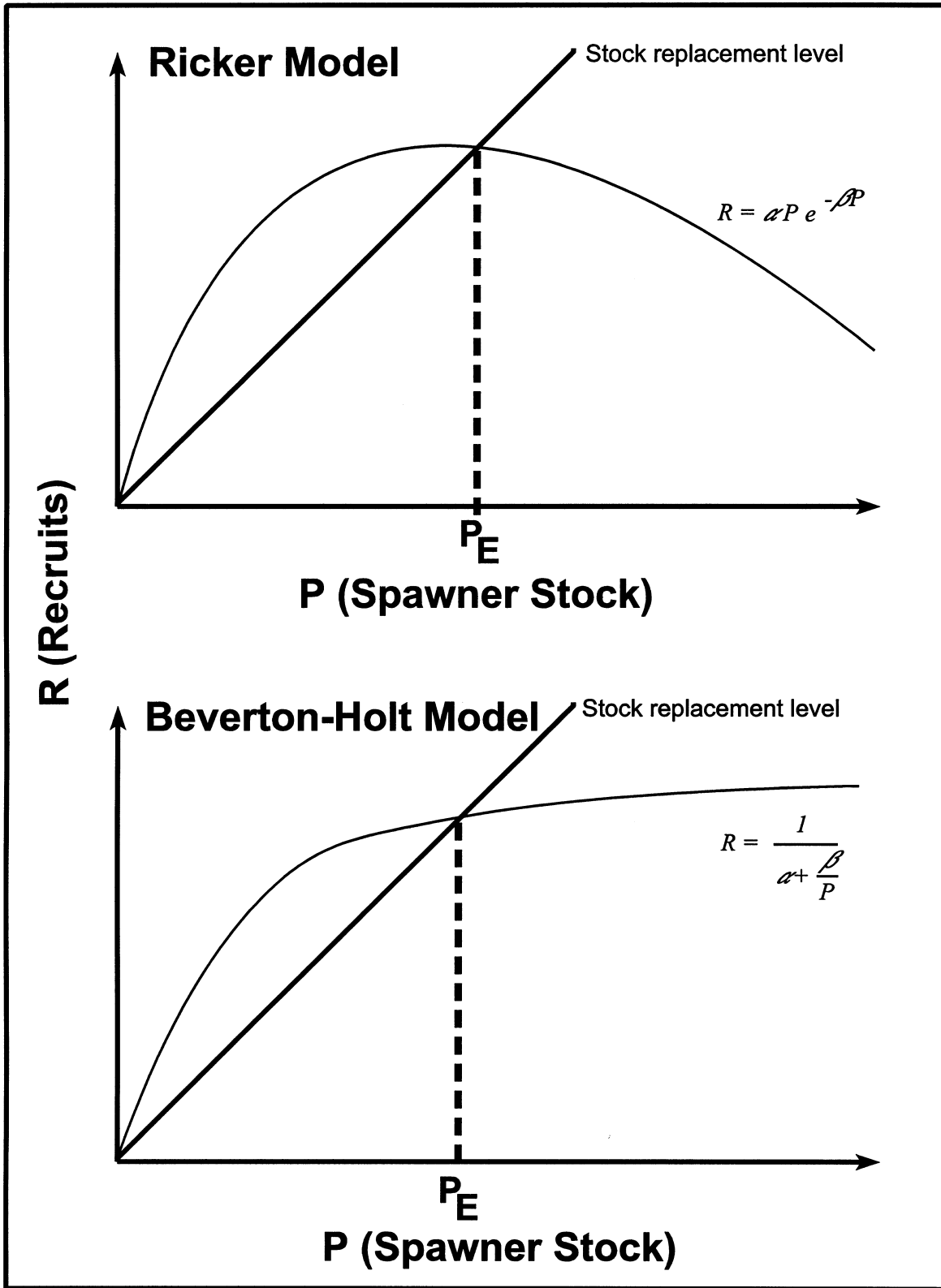
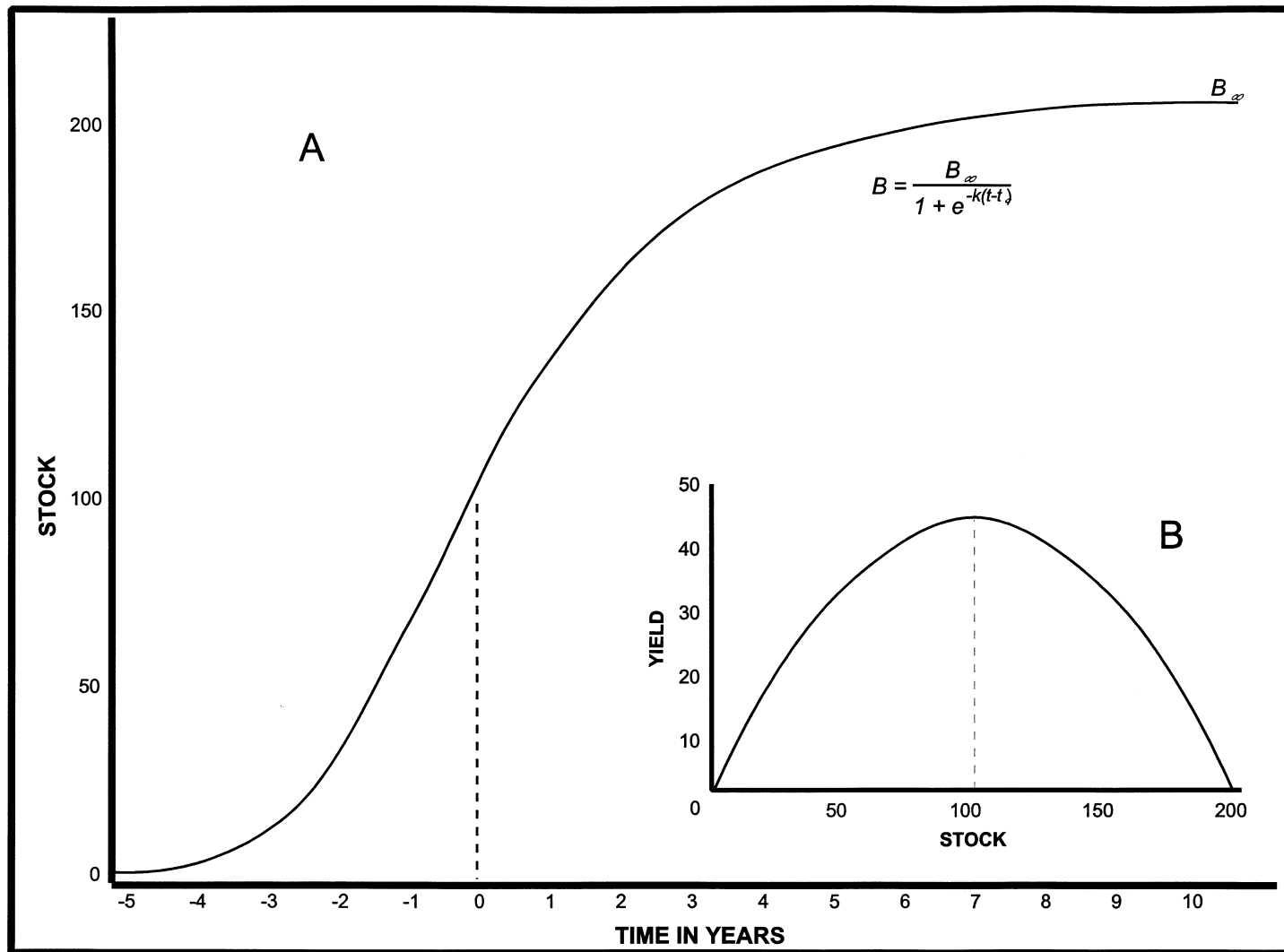

Figure 2-1  
Generic examples of Ricker and Beverton-Holt type stock recruitment curves.





**Figure 2-2**  
 Generic example of logistical growth curve (A) and associated parabolic relationship (B) between yield (effort) and stock size.

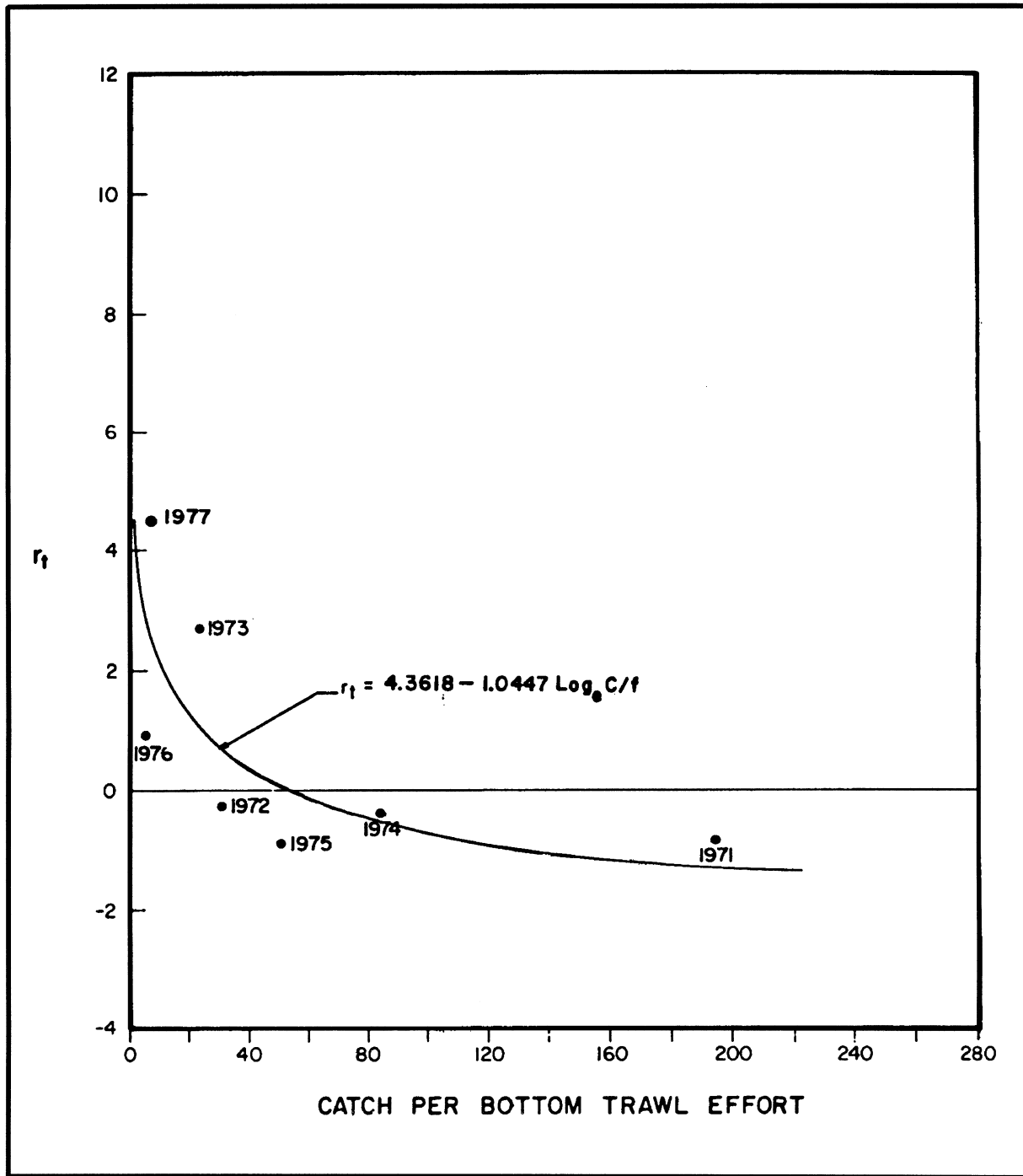

Figure 2-3  
Relationship between population growth rate of young of the year Hudson River striped bass and catch per unit of sampling effort. (From LMS 1980a)

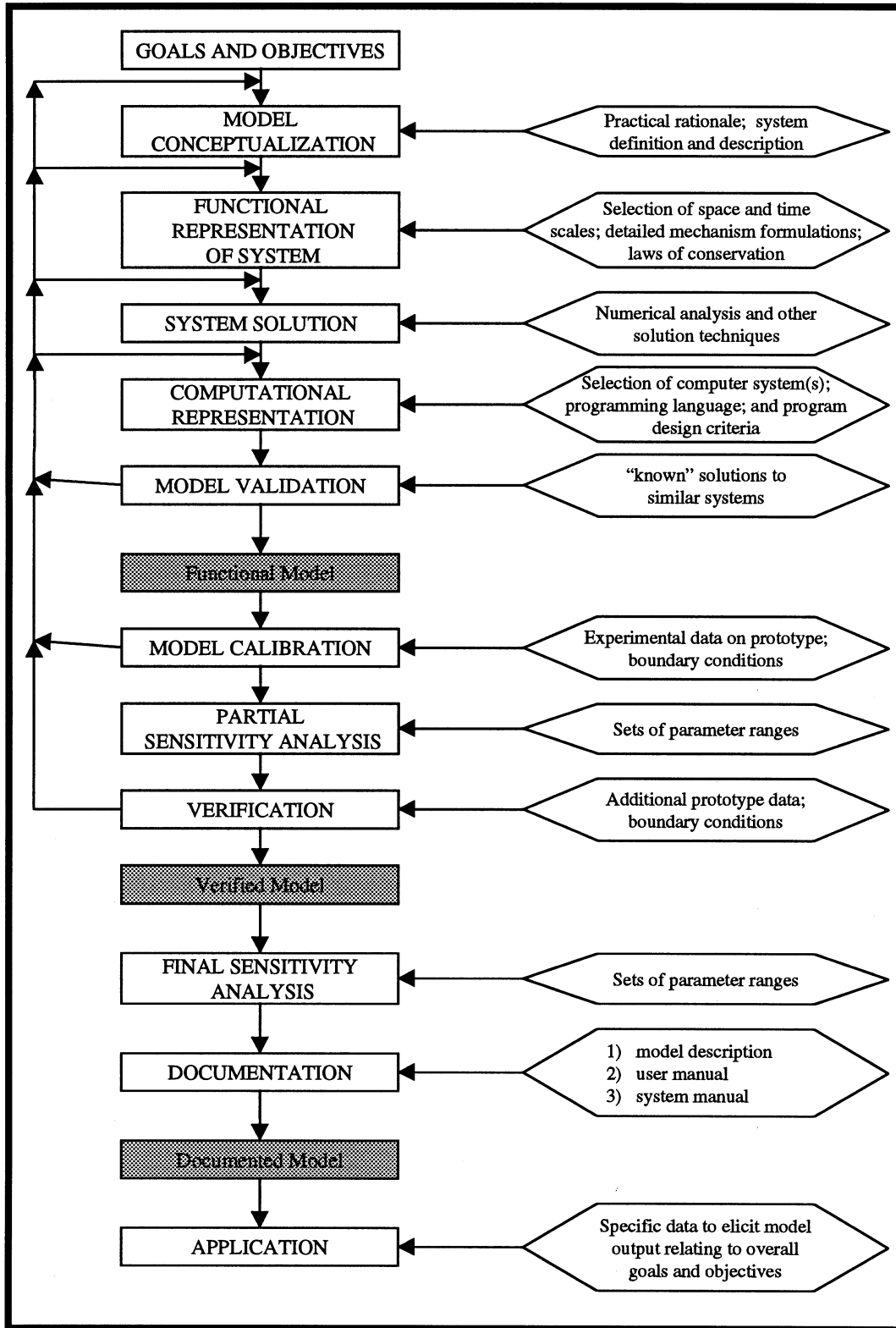

Figure 2-4  
Developmental steps involved in model construction. (Adapted from LMS 1980b)

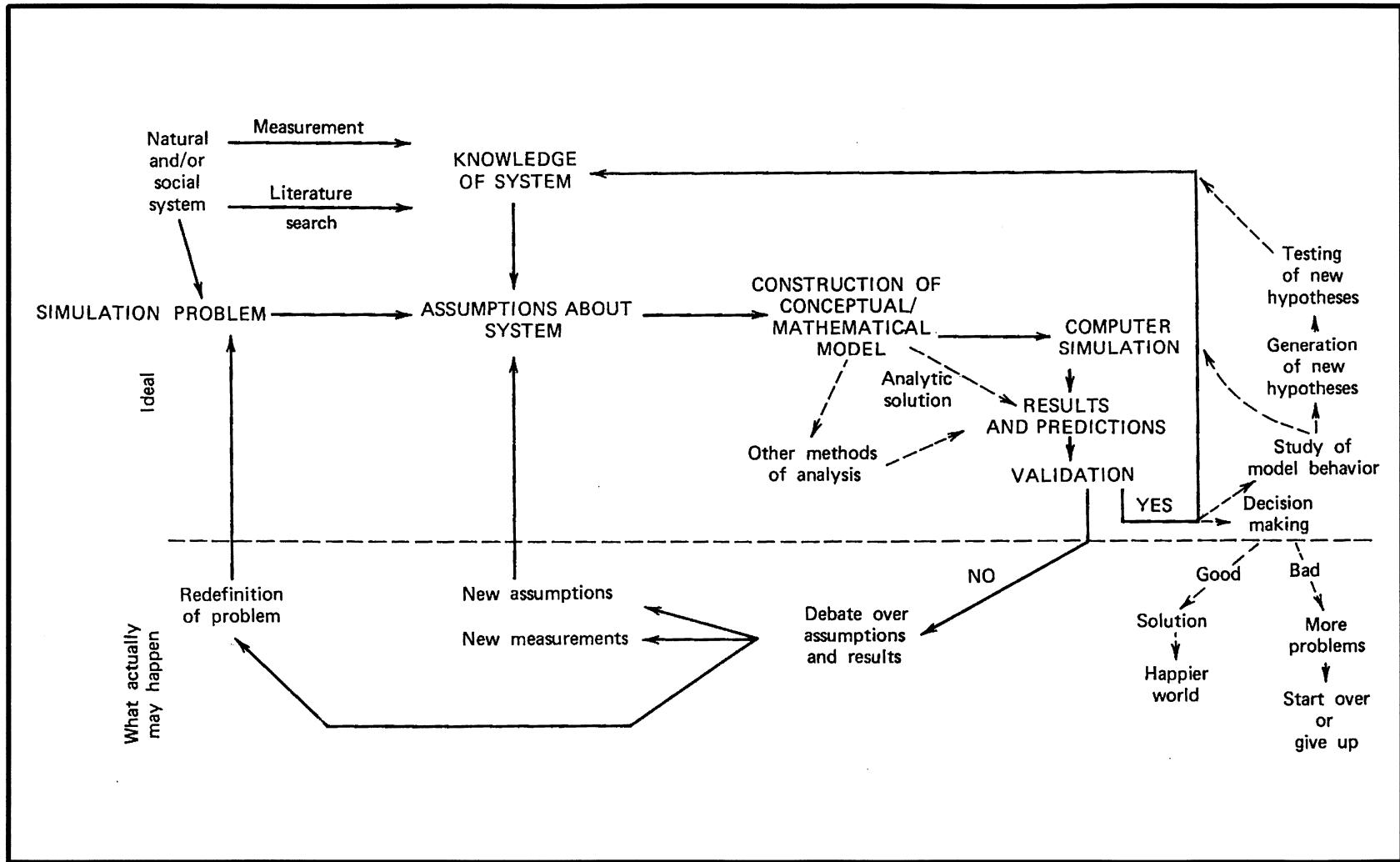

Figure 2-5  
Diagram of the model-building process. (From Hall and Day 1977)

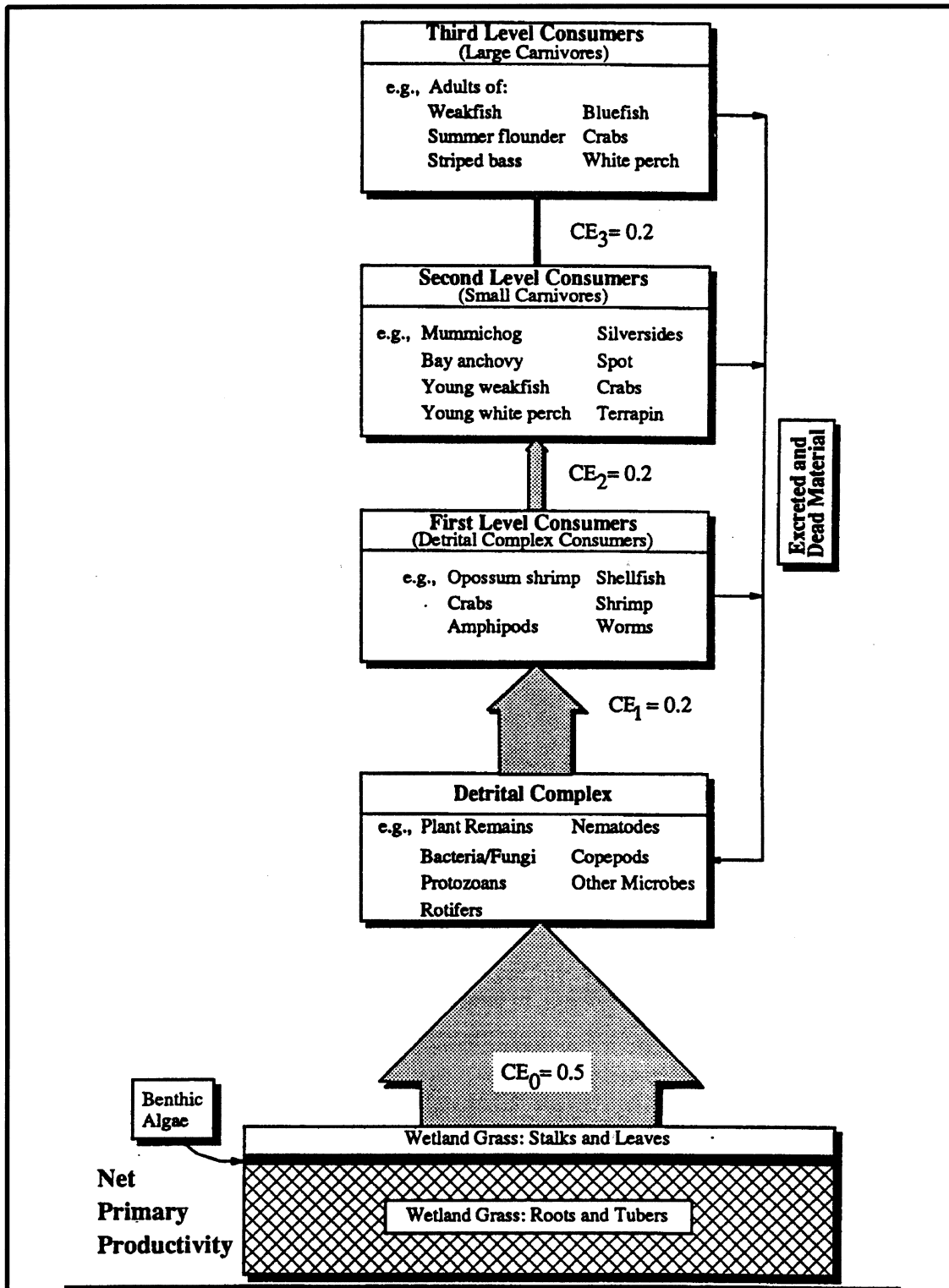

Figure 2-6  
 Aggregated food chain model for wetland-based aquatic food chain in the Delaware Estuary. (From PSE&G 1993a)

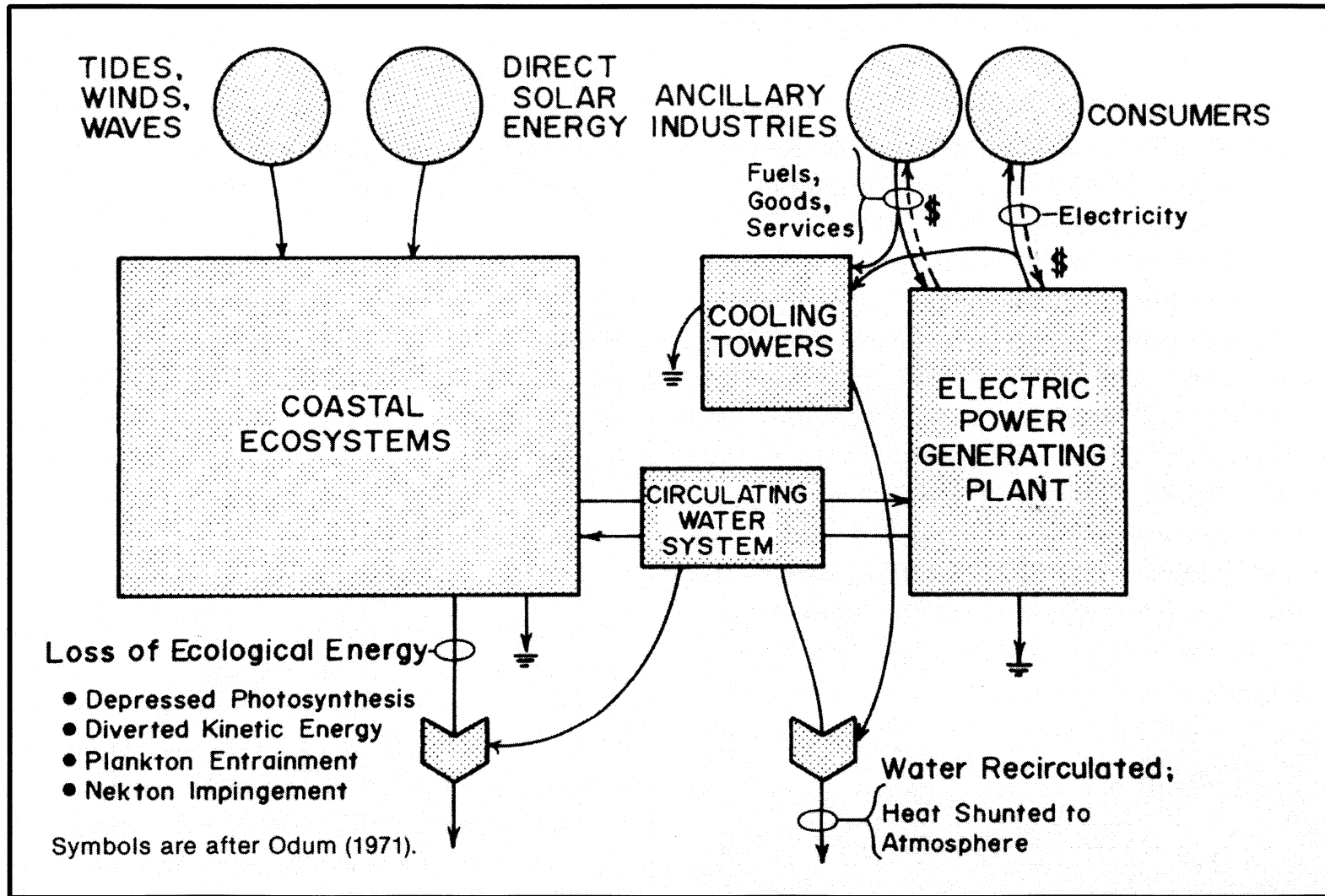

Figure 2-7  
 Conceptual interaction between a power plant and coastal ecosystem, including the economic and energy costs associated with cooling towers. (From Kemp 1981)

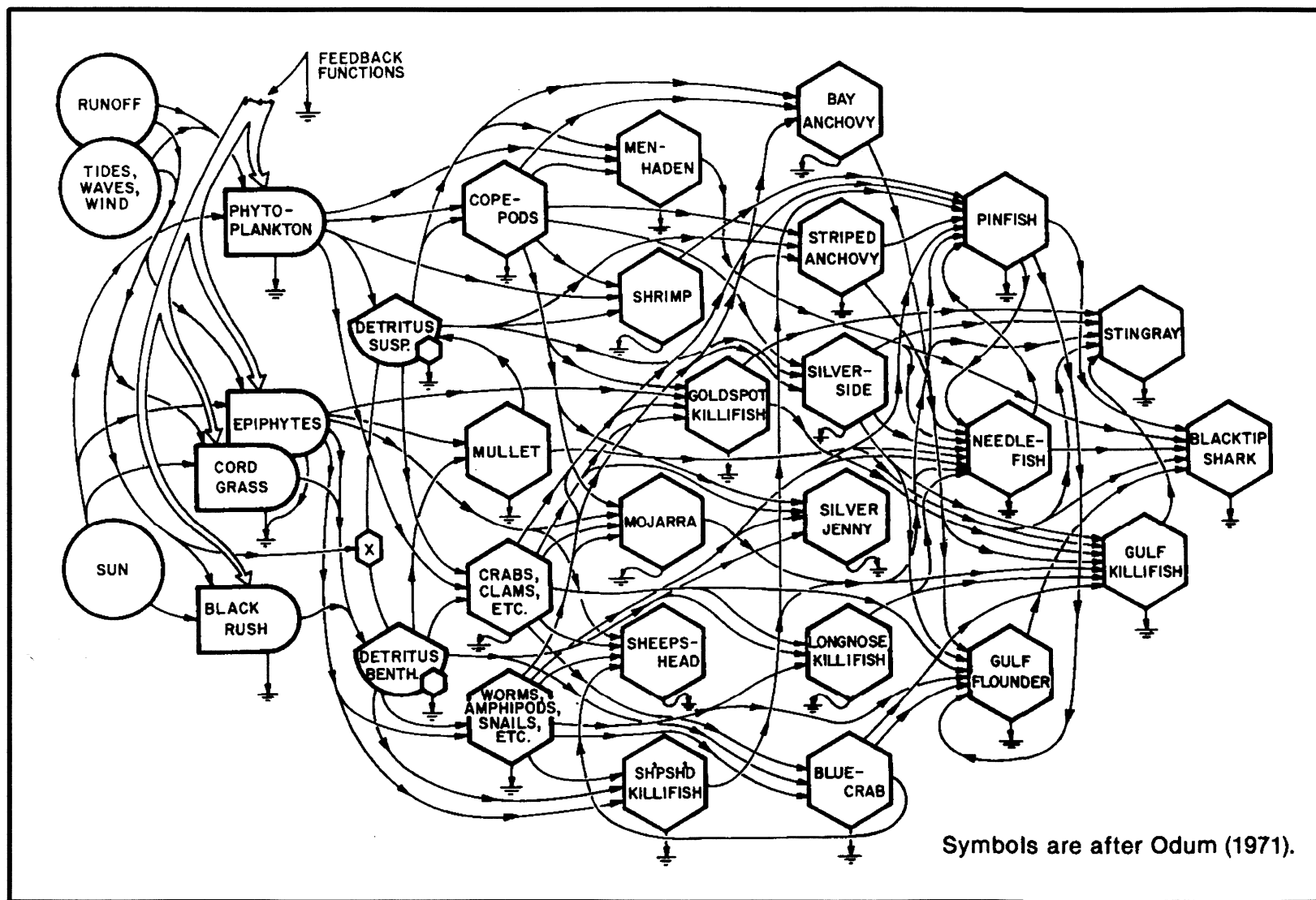

Figure 2-8  
 Conceptual diagram of trophic web in an estuarine ecosystem near Crystal River power plant. (From Kemp 1981)

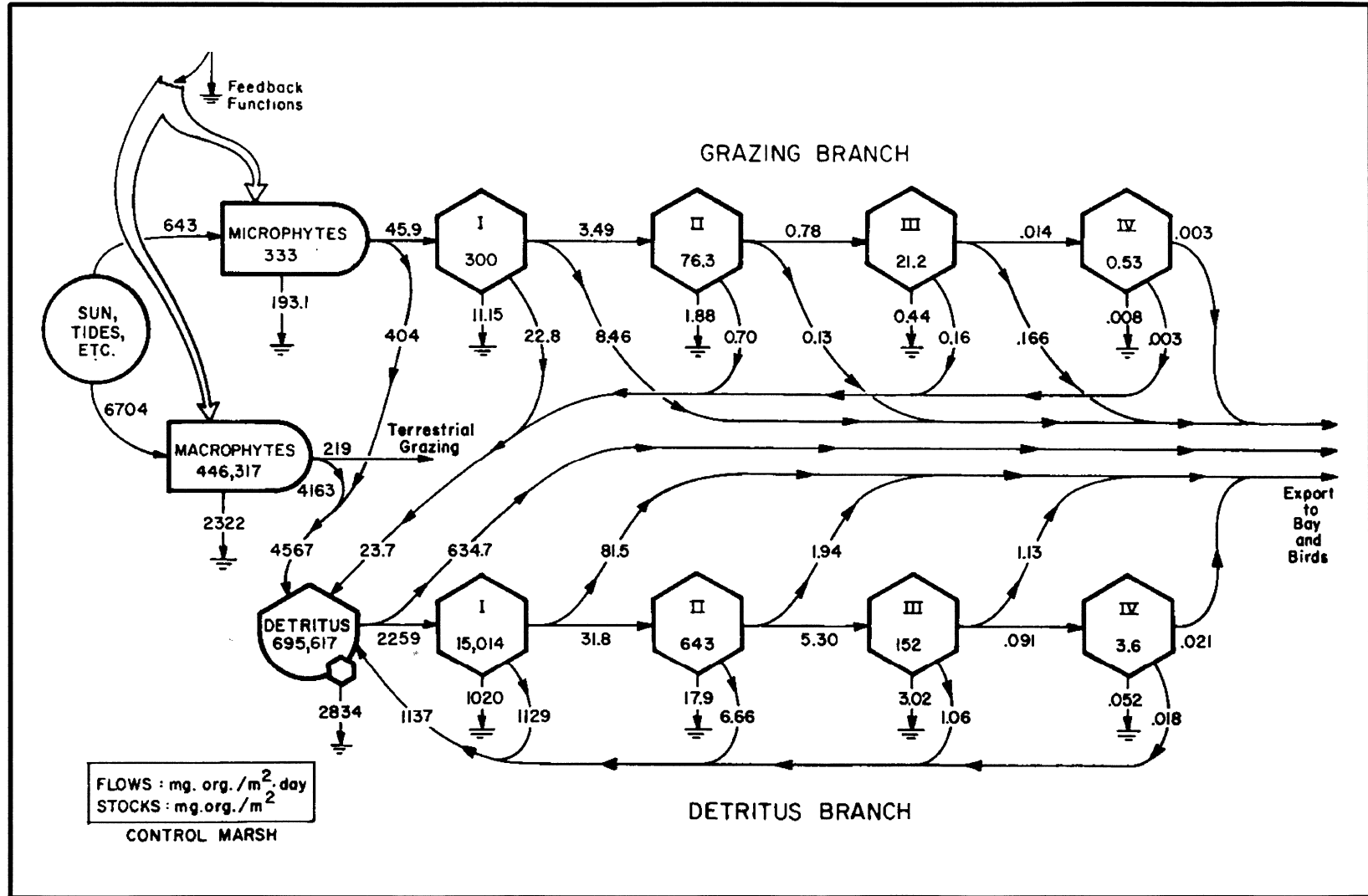
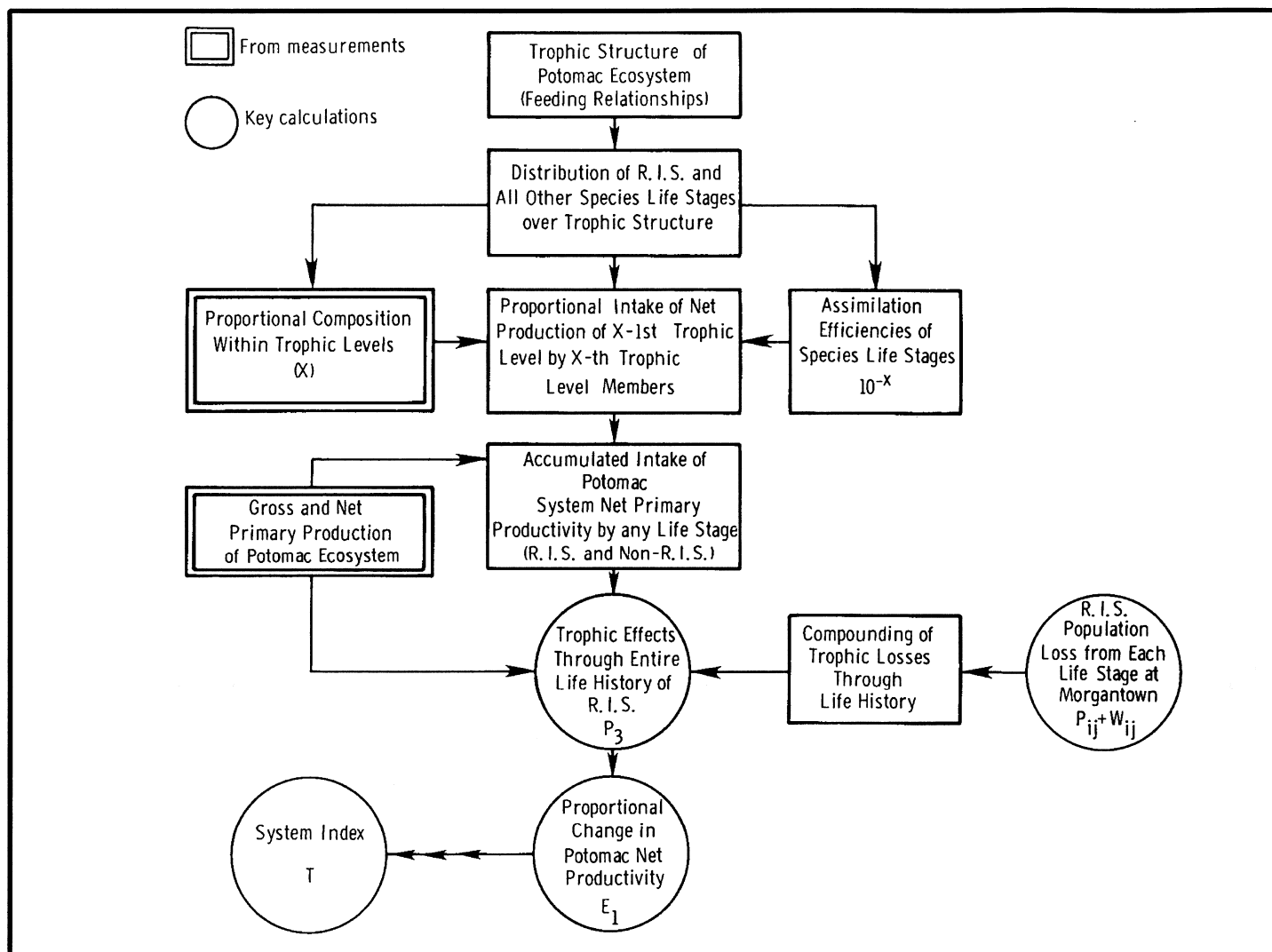

Figure 2-9  
 Trophic-level diagram derived by transforming quantitative data associated with food-web model depicted in Figure 2-8.  
 (From Kemp 1981)





**Figure 2-10**  
**Model for estimation of the ecosystem effects associated with population losses due to entrainment at Morgantown power plant. (From Polgar et al. 1981)**

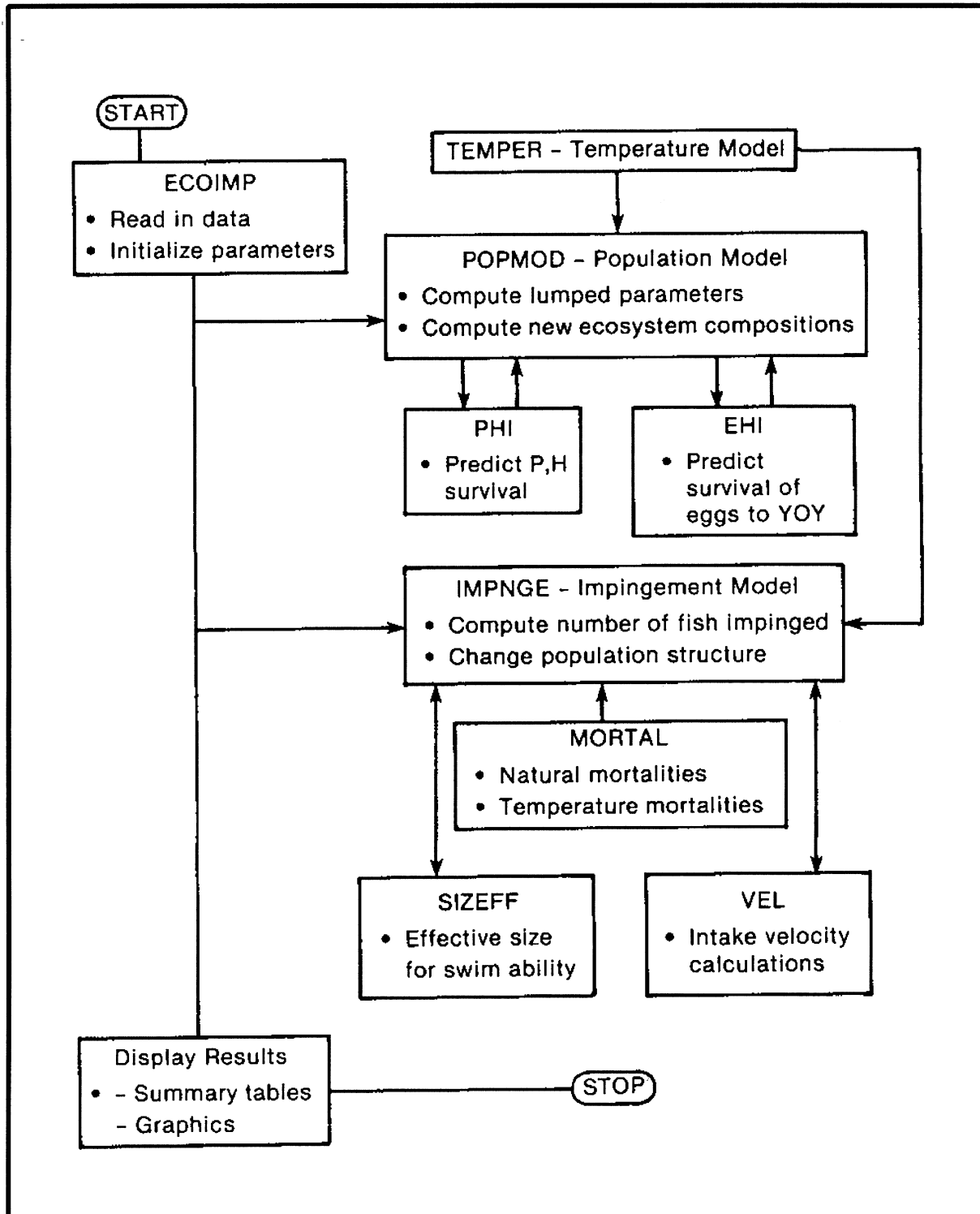

Figure 2-11  
 Diagram of ECOIMP model showing various components and their relationships.  
 (From Logan and Kleinstreuer 1981)

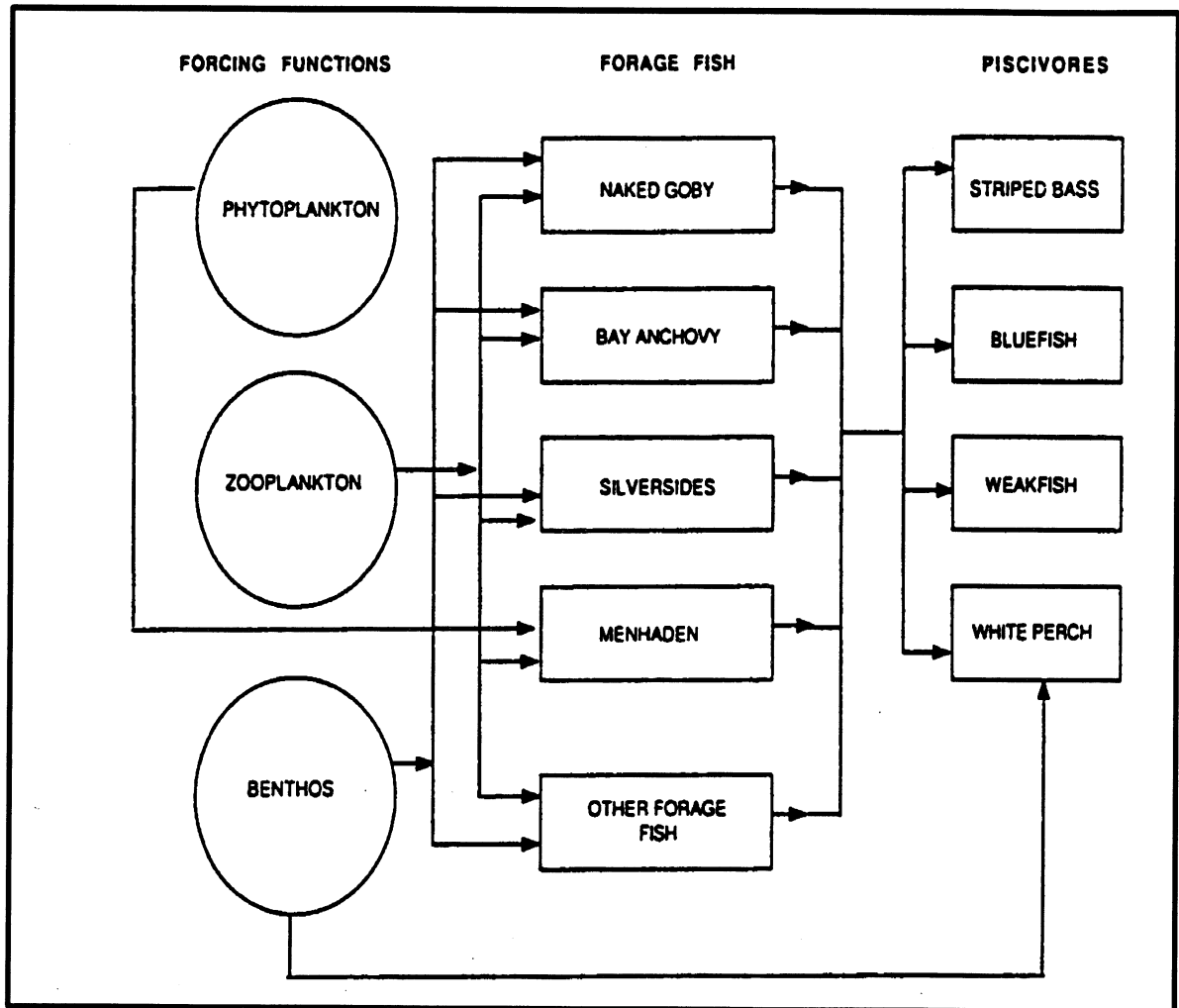

Figure 2-12  
Schematic conceptual foreview of the Patuxent Estuarine Trophic Simulation (PETS) model. (From Summers 1989)

**Table 2-1  
Summary of Method Characteristics: Equivalent Adult Model**

Type of Questions/Issues Addressed	Provides estimates of equivalent numbers lost owing to power plant operation. Results often compared to “acceptable” losses such as commercial and/or recreational fishing harvests.
Data Input Requirements	Annual estimates of power plant-related loss for each life stage/age; total mortality rate from each life stage/age to age of equivalency; life stage/age durations.
Inherent Assumptions	Total mortality constant within life stage/age and across entire geographic range; total mortality instantaneously changes between life stages/ages; no compensatory mortality.
Scope of Method	Estimation of equivalent numbers of individuals lost as a result of power plant-related losses across several life stages/ages.
Taxa Applicability	Most aquatic plant, invertebrate and vertebrate populations.
Habitat Applicability	Most freshwater, estuarine, and marine aquatic habitat
Peer Review /Use in Regulatory Setting	Method described peer reviewed scientific literature and in official publication of U.S. Fish and Wildlife Service. It has been one of the most commonly used methods in predictive 316 (b) assessments.
Level of Expertise required	Requires experienced aquatic/fisheries biologist knowledgeable in population dynamics of target taxa
Relative Cost to Use	Low - moderate; requires empirically-based power plant-related losses; total mortality inputs could be based on information from scientific literature.
Nature of Results	Results are quantitative within the limits of data available and model assumptions
Relationship to Other Methods	Similar in concept to the production forgone model.

**Table 2-2**  
**Summary of Method Characteristics: Lost Reproductive Potential Model**

Type of Questions/Issues Addressed	Provides estimates of annual reproductive effort lost owing to power plant operation.
Data Input Requirements	Abundance for each life stage/age; total mortality rate for each life stage/age with and without power plant operations; life stage/age durations; life stage/age specific maturity and young production rates.
Inherent Assumptions	Life history parameters constant within life stage/age and across entire geographic range; parameters instantaneously changes between life stages/ages; no compensatory mortality.
Scope of Method	Estimation of annual production of young not realized as a result of power plant-related losses across several life stages/ages.
Taxa Applicability	Most aquatic plant, invertebrate and vertebrate populations.
Habitat Applicability	Most freshwater, estuarine, and marine aquatic habitat
Peer Review/Use in Regulatory Setting	Method has been used in a limited number of predictive 316 (b) assessments. Conceptually similar approach has been used to assess population effects of chronic toxicity.
Level of Expertise required	Requires experienced aquatic/fisheries biologist knowledgeable in population dynamics of target taxa
Relative Cost to Use	Moderate-high; requires total mortality rates with and without power plant operation and total abundance; other parameters could be based on information from scientific literature.
Nature of Results	Results are quantitative within the limits of data available and model assumptions

**Table 2-3**  
**Summary of Method Characteristics: Production Foregone Model**

Type of Questions/Issues Addressed	Provides estimates of production forgone owing to power plant operation. Results can be compared ecosystem productivity and to "acceptable" harvests such as through commercial and/or recreational fishing.
Data Input Requirements	Annual estimates of power plant-related loss for each life stage/age; total mortality rate from each life stage/age to age of equivalency; life stage/age durations life stage/age specific production.
Inherent Assumptions	Total mortality and mean production constant within life stage/age and across entire geographic range; total mortality instantaneously changes between life stages/ages; no compensatory mortality.
Scope of Method	Estimation of annual production not realized (forgone) as a result of power plant-related losses across several life stages/ages.
Taxa Applicability	Most aquatic plant, invertebrate and vertebrate populations.
Habitat Applicability	Most freshwater, estuarine, and marine aquatic habitat
Peer Review/Use in Regulatory Setting	Method described peer reviewed scientific literature and has been used in several predictive 316 (b) assessments.
Level of Expertise required	Requires experienced aquatic/fisheries biologist knowledgeable in population dynamics and bioenergetics of target taxa
Relative Cost to Use	Low - moderate; requires empirically-based power plant-related losses; total mortality inputs and production could be based on information from scientific literature.
Nature of Results	Results are quantitative within the limits of data available and model assumptions
Relationship to Other Methods	Similar in concept to the equivalent adult model.

**Table 2-4**  
**Summary of Method Characteristics: Water Ratio**

Type of Questions/Issues Addressed	Estimates the fractional losses of planktonic taxa/lifestages due to entrainment based on the ratio of cooling water flow to river flow; often a preliminary analysis performed to evaluate the need for further, more complex analyses
Data Input Requirements	Cooling water flow, source river flow data, plankton densities at cooling water intake/discharge, plankton densities in nearfield river segment, through-plant entrainment mortality, proportion dead in river population
Inherent Assumptions	Homogeneous distribution of planktonic stages within river cross-section, sampling/gear biases are comparable/quantified in river and in plant, active migration or behavioral movements of organisms do not significantly affect distribution
Scope of Method	Provides estimate of losses relative to organisms of species/lifestage passing the intake
Taxa Applicability	Planktonic species and/or lifestages
Habitat Applicability	Tidal and non-tidal rivers
Peer Review/Use in Regulatory Setting	Several examples published in proceedings of technical meetings
Level of Expertise required	Basic fisheries biologist training
Relative Cost to Use	Moderate; requires labor-intensive field work and laboratory processing of biological samples
Nature of Results	Quantitative results with a recognition of potential biases related to sampling/data assumptions
Relationship to Other Methods	Simplistic variation of exploitation rate methods

**Table 2-5  
Summary of Method Characteristics: Habitat Area/Volume Ratio**

Type of Questions/Issues Addressed	Provide estimates of areas/cross-sections/volumes of exclusion or organism losses relative to available habitat for selected taxa/lifestages
Data Input Requirements	Estimate of area/volume of target habitat within near field, far field, population range; area/volume of discharge plume within specified parameter isopleths
Inherent Assumptions	All specific habitat types are equally utilized within the region being evaluated
Scope of Method	Application of individual level dose-response data to assess population effects based on discharge plume characteristics
Taxa Applicability	Most populations/lifestages of aquatic plants, invertebrates and vertebrates
Habitat Applicability	Most freshwater, estuarine, and marine aquatic habitat
Peer Review/Use in Regulatory Setting	Has been used extensively in predictive 316 (a) Demonstrations
Level of Expertise Required	Requires experienced hydrologist for plume mapping and analyses and aquatic/fisheries biologist knowledgeable in ecotoxicology, biothermal literature, and habitat requirements of target taxa
Relative Cost to Use	Moderate; requires mapping/modeling of discharge plume distribution characteristics depending on hydrodynamic complexity of system; habitat quantification may require only generalized characterization of habitat extent or more intensive mapping of specific habitat
Nature of Results	Results are quantitative within the limits and assumptions of the plume and habitat mapping



**Table 2-6**  
**Summary of Method Characteristics: Exploitation Rates**

Type of Questions/Issues Addressed	Relative estimate of losses may be used for direct assessment of power plant effects or serve as input to interim steps of more complex population/community modeling
Data Input Requirements	Measurement of cropping (entrainment/impingement) at the power plant; measurement/estimation of the taxa standing crop in the source waterbody
Inherent Assumptions	Any assumption inherent in the sampling design and procedures used for estimation of numbers entrained/impinged or the size of the initial population
Scope of Method	Estimates the fraction of the initial population size that is lost as a result of power plant operations
Taxa Applicability	Aquatic invertebrate and vertebrate taxa
Habitat Applicability	Most freshwater, estuarine, and marine habitats
Peer Review/Use in Regulatory Setting	Descriptions and applications common in peer reviewed literature related to fisheries management
Level of Expertise required	Basic fisheries biologist training
Relative Cost to Use	Moderate to expensive depending on complexity and duration of studies required to quantify population standing crop and number of individual taxa to be analyzed
Nature of Results	Quantitative estimation of losses relative to population standing crop
Relationship to Other Methods	More complex development of Habitat Ratio methods

**Table 2-7  
Summary of Method Characteristics: Abundance Weighted Affected Area/Volume Ratio**

Type of Questions/Issues Addressed	Provides estimates of annual conditional mortality for the population as a whole.
Data Input Requirements	Volume of cooling water withdrawn from each vertical stratum; volume of nearfield and farfield areas; life stage-specific distribution patterns; life stage durations and period of total entrainment vulnerability; estimated entrainment mortality.
Inherent Assumptions	Data inputs are constant within each model time step; natural mortality constant within time step across entire geographic range; data inputs instantaneously change between model time steps; no compensatory mortality.
Scope of Method	Estimation of fractional loss to population as a result of entrainment in cooling water withdrawals.
Taxa Applicability	Most planktonic lifestages of aquatic plant, invertebrate and vertebrate populations.
Habitat Applicability	Most freshwater, estuarine, and marine aquatic habitat
Peer Review /Use in Regulatory Setting	Method used as screening tool for predictive 316 (b) Assessments.
Level of Expertise required	Requires hydrologist for estimation of volumes and an experienced aquatic/fisheries biologist knowledgeable in early life stage population dynamics and distribution patterns of target taxa
Relative Cost to Use	Moderate; requires empirically-based distribution information on each vulnerable life stage; data inputs could be based on general life history information with coincident loss of precision.
Nature of Results	Results are quantitative within the limits of data available and model assumptions
Relationship to Other Methods	Generally similar in approach to Empirical Transport Model although data requirements and hence, precision are lower.

**Table 2-8  
Summary of Method Characteristics: Empirical Transport Model**

Type of Questions/Issues Addressed	Provides estimates of annual conditional mortality for the population as a whole.
Data Input Requirements	Volume of cooling water withdrawn; volume of nearfield area; life stage-specific distribution patterns; life stage durations and period of total entrainment vulnerability; estimated entrainment mortality; ratio of density of organisms in cooling water to density in nearfield area.
Inherent Assumptions	Data inputs are constant within each model time step; natural mortality constant within time step across entire geographic range; data inputs instantaneously change between model time steps; no compensatory mortality.
Scope of Method	Estimation of fractional loss to population as a result of entrainment in cooling water withdrawals.
Taxa Applicability	Most planktonic lifestages of aquatic plant, invertebrate and vertebrate populations.
Habitat Applicability	Most freshwater, estuarine, and marine aquatic habitat
Peer Review/Use in Regulatory Setting	Method published in peer reviewed scientific literature and has been used extensively in predictive 316 (b) Assessments.
Level of Expertise required	Requires hydrologist for estimation of volumes and an experienced aquatic/fisheries biologist knowledgeable in early life stage population dynamics and distribution patterns of target taxa
Relative Cost to Use	Moderate - high; requires empirically-based distribution information on each vulnerable life stage; data inputs could be based on general life history information with coincident loss of precision.
Nature of Results	Results are quantitative within the limits of data available and model assumptions
Relationship to Other Methods	Similar in concept although inclusive of more information than density-weighted habitat ratio method.

**Table 2-9  
Summary of Method Characteristics: Empirical Impingement Model**

Type of Questions/Issues Addressed	Provides estimates of annual conditional mortality for the population as a whole.
Data Input Requirements	Estimates of impingement loss of each life stage/age for each model time step; natural mortality rates for each life stage/age for each model time step; total population size at the beginning of each model time step.
Inherent Assumptions	Data inputs are constant within each model time step; natural mortality constant within time step across entire geographic range; data inputs instantaneously change between model time steps; no compensatory mortality.
Scope of Method	Estimation of fractional loss to population as a result of impingement against intake screens.
Taxa Applicability	Most aquatic invertebrate and vertebrate populations.
Habitat Applicability	Most freshwater, estuarine, and marine aquatic habitat
Peer Review/Use in Regulatory Setting	Method described in official publication of Oak Ridge National Laboratories and has been used in heavily litigated predictive 316 (b) assessments.
Level of Expertise required	Requires experienced aquatic/fisheries biologist knowledgeable in population dynamics of target taxa
Relative Cost to Use	Moderate - high; requires empirically-based population estimates; data inputs could be based on general life history information with coincident loss of precision.
Nature of Results	Results are quantitative within the limits of data available and model assumptions
Relationship to Other Methods	Allows conversion of exploitation rate to conditional mortality rate.

**Table 2-10**  
**Summary of Method Characteristics: Hydrodynamic Models**

Type of Questions/Issues Addressed	Estimation of fractional losses to population/stock due to power plant entrainment
Data Input Requirements	Independent data sets for calibration and verification of the model. Requires data on morphometry, flows (freshwater and tidal as appropriate), currents (velocity and patterns), stratification, mixing (dispersion and convection), general and site-specific organism life history information (e.g., egg production, survival rates, migration and characteristics of spawning stock)
Inherent Assumptions	Distribution of the taxa/lifestage is primarily a function of water currents
Scope of Method	Integrates physical and biological processes for impact assessment. Uses model of source waterbody hydrodynamic processes to predict distribution of planktonic organisms and their vulnerability to cooling water system entrainment.
Taxa Applicability	Lifestages which are planktonic with limited mobility
Habitat Applicability	Most commonly used in tidal situations to simulate the effect of tide reversal on organism movement and distribution, but have been developed for most open water aquatic habitat
Peer Review/Use in Regulatory Setting	A number of models have appeared in peer reviewed literature and have undergone extensive scrutiny by regulatory and resource agencies and in adjudicatory hearings
Level of Expertise required	Experienced hydrologist or physical oceanographer, and fisheries scientist
Relative Cost to Use	Historically these models have been relatively expensive with need for independent data sets and access to mainframe computers. With increase in capacity of desktop computers the cost to run complex hydrodynamic models will continue to decrease.
Nature of Results	Distribution and population size at the end of specified lifestages/time periods, fractional reduction for each lifestage, cumulative reduction over all lifestages
Relationship to Other Methods	Conceptual extension of ratio models with considerable increase in data requirements, model complexity, and output detail

**Table 2-11**  
**Summary of Method Characteristics: Stock Recruitment Models**

Type of Questions/Issues Addressed	Incremental entrainment and impingement effects on populations
Data Input Requirements	Long-term annual population survey database for calculation of recruit and spawner abundance indices
Inherent Assumptions	The population is at equilibrium, that is, reproduction and mortality are balanced. Density dependent and density-independent factors interact to maintain this equilibrium. Population has a stable age distribution
Scope of Method	Stock/population level assessment method providing estimate of equilibrium population percent reduction.
Taxa Applicability	Can be applied to most taxa which do not have multiple overlapping generations completed within a single spawning season
Habitat Applicability	Any aquatic habitat in which spawner and recruit segments of the population can be readily sampled and sampling biases are understood and can be estimated for both groups
Peer Review /Use in Regulatory Setting	Numerous applications in fisheries management and well represented in fisheries scientific literature. SRR models have been key component of power plant impact studies and regulatory reviews including the Hudson River case (Barnthouse et al. 1988)
Level of Expertise required	Experienced quantitative fisheries scientist
Relative Cost to Use	Can be expensive if long-term data adequate to estimate annual population abundance indices is not pre-existing and must be collected
Nature of Results	Estimate of fractional reduction in equilibrium population due to power plant related losses
Relationship to Other Methods	Has been incorporated to represent population level effects in community/ecosystem models; related to many management-based yield models

**Table 2-12**  
**Summary of Method Characteristics: Logistic Population Growth Model**

Type of Questions/Issues Addressed	Can provide indication of presence of density-dependent mechanisms
Data Input Requirements	Annual catch per unit effort data at a fixed period (e.g., end of the growing season)
Inherent Assumptions	Population assumed to be at equilibrium; population size assumed to be proportional to catch per unit of effort; catch effort data will reflect the effects of mortality from natural sources and human activity
Scope of Method	Provides a measure of effects at the single population or stock level
Taxa Applicability	Can be applied to most taxa which do not have multiple overlapping generations completed within a single spawning season
Habitat Applicability	Any aquatic habitat in which the population can be readily sampled and sampling biases are understood and can be estimated
Peer Review/Use in Regulatory Setting	Numerous applications in fisheries management and well represented in fisheries scientific literature.
Level of Expertise required	Experienced fisheries scientist
Relative Cost to Use	If data from other programs is not available, moderately high cost due to need for multiple years of catch data
Nature of Results	Measure of potential reduced production; reduction measured relative to unimpacted population
Relationship to Other Methods	Management-based yield models

**Table 2-13**  
**Summary of Method Characteristics: Yield-Per-Recruit Model**

Data Input Requirements	Extensive data on losses, catch effort, age and size composition
Inherent Assumptions	Assume equilibrium population and recruitment is independent of adult stock size
Scope of Method	Analysis focused on post recruitment age classes; therefore, most applicable to sites where operational effects are primarily on these age groups or where impingement of yearling and older fish is significant. Instantaneous mortality and growth rates are constant within each age, size, or time interval into which the analysis is segmented
Taxa Applicability	Can be applied to most taxa which do not have multiple overlapping generations completed within a single spawning season
Habitat Applicability	Any aquatic habitat in which post-recruit segments of the population can be readily sampled and sampling biases are understood and can be estimated for both groups
Peer Review/Use in Regulatory Setting	Numerous applications in fisheries management and well represented in fisheries scientific literature. Not commonly used in power plant applications, because application of this method is limited to losses at older age classes, while power plant operations more typically effect yearling or younger age classes
Level of Expertise required	Experienced fisheries scientist
Relative Cost to Use	Moderately expensive due to need for age/size structure data
Nature of Results	Changes in yield (biomass) are expressed as a function of fishing mortality (power plant losses) and the distribution of losses across age/size classes
Relationship to Other Methods	Management-based yield models
Type of Questions/Issues Addressed	Effects of impingement of post-recruitment age classes; evaluation of relative effects of alternative technology or operational modes



**Table 2-14**  
**Summary of Method Characteristics: Age/Cohort Structured Models (Leslie Matrix)**

Type of Questions/Issues Addressed	Assesses change in population abundance with time. Effects of incremental mortality due to power plants can be superimposed and evaluated. Probability of population decline can be investigated.
Data Input Requirements	Basic model requires age-specific abundance, survival, and fecundity data for target species, as well as fraction of females that are sexually mature. Stochastic/density-dependent applications need distributions of life history data plus some density-dependent function.
Inherent Assumptions	Basic model assumes spawning once per year or season over a brief period, and that survival and fecundity rates are constant. The latter assumption is eliminated in stochastic versions.
Scope of Method	Population level analysis. Used to predict the abundance of a population at some future time.
Taxa Applicability	Broadly applicable, providing target species spawn at discrete time periods, and requisite life history data are available, or can be obtained.
Peer Review/Use in Regulatory Setting	Basic method is nearly 60 years old, with many published applications; has been used in a number of power-plant impact assessments.
Level of Expertise required	Requires fisheries science and computer modeling expertise.
Relative Cost to Use	Costs low to moderate if requisite life history data are available. Cost increases substantially if field programs necessary for life history data.
Nature of Results	Basic model results are quantitative. Stochastic versions provide probabilistic results.
Relationship to Other Methods	Analogous to other age/stage-structured models that use mathematical formulations other than matrix algebra.

**Table 2-15**  
**Summary of Method Characteristics: Individual-Based Models**

Type of questions/issues addressed	Assesses change in population abundance with time. Effects of additional mortality due to power plants can be superimposed and evaluated. Probability of population decline can be investigated.
Data input requirements	Varies, but typically data intensive. For individual animals, data are needed on reproduction, growth (size), survival, mortality, and other factors; information derived from field and laboratory data.
Inherent assumptions	The properties of populations derive from properties of individuals. Assessment of individual attributes is more realistic than assessment of attributes of "average" individuals.
Scope of method	Population level analysis; but may be expanded to situations of interspecies interaction.
Taxa applicability	Broadly applicable, providing requisite life history data are available, or can be obtained. EPRI's CompMech key species models may be adapted to other species with similar life histories.
Peer review and/or use in regulatory setting	Numerous peer-review applications in last 10 years; few direct power-plant impact assessment applications to date.
Level of expertise required	Requires fisheries science and computer modeling expertise.
Relative cost to use	Relatively expensive and labor intensive, although can be minimized by iterations of increasing complexity, as necessary.
Nature of results	Population-projection simulations.
Relationship to other methods	Although they deal with the same population parameters as other models, the tracking of individual attributes makes this approach unique.

**Table 2-16**  
**Summary of Method Characteristics: Community/Ecosystem Models**

Type of Questions/Issues Addressed	What are direct and indirect system-wide effects of power plant related losses; effects of alternative technology or operating scenarios at community/ecosystem level
Data Input Requirements	Highly variable among model applications, but generally very extensive across multiple trophic levels
Inherent Assumptions	Essential ecosystem functions, interactions, and characteristics can be reasonably represented in a simplified fashion by an integrated series of mathematical formulations
Scope of Method	Translate the direct losses of organisms to a population(s) to indirect effects on other segments of the biotic community or ecosystem
Taxa Applicability	Any taxa at any trophic level depending on the scope of the questions being evaluated
Habitat Applicability	All aquatic and terrestrial habitat potentially effected by power plant operations
Peer Review/Use in Regulatory Setting	Extensive coverage in scientific literature including several peer reviewed journals dedicated specifically to ecosystem modeling
Level of Expertise required	Experienced systems ecologist and fisheries scientist
Relative Cost to Use	Wide range of cost, rapidly increasing with increase in model complexity with need for independent data sets for validation, calibration, and verification
Nature of Results	Form of results can vary widely among models; examples include changes (at various trophic level or to populations) in growth, production, numbers
Relationship to Other Methods	Takes assessment to highest level of organizational and organism complexity



# 3

## RETROSPECTIVE METHODS

---

### 3.1 Overview

Retrospective methods utilize empirical data collected in the receiving waterbody to evaluate the character, function, quality, and/or integrity of that body, and/or to evaluate whether or not a change in a population/community/ecosystem has occurred that may be related to operation of the power plant. These methods provide a direct look at how the biological entity has responded to the array of environmental stressors (including the power plant). Such methods look at temporal trends or spatial patterns on a long-term basis, or based on before and after datasets. Depending on the characteristics of the database, however, particular care must be exercised to differentiate power plant effects from the effects of other stressors. There are several different approaches available to determine if have occurred as a result of power plants' operations.

Retrospective methods are best applied to assess changes in populations or communities as a result of power plant operation at facilities that have been operating for a period of at least several years. To properly assess potential impacts the facility should have been in operation for at least the number of years equaling the average generation time of key species in the community, and during periods in which at least a representative range of hydrologic and meteorological conditions occurred. (In some cases, extreme hydrologic and meteorological conditions need to have occurred.) Unlike predictive assessments, the population or community of interest has been exposed to the potential power-plant-related stressors and any effects which are likely to occur should be reflected in the existing community. Retrospective methods are also valuable prior to plant operation, for determining the quality, character, or integrity of aquatic communities or populations and/or to establish baseline conditions.

The applications of the methods presented in the following sections are not intended to be exhaustive, but rather representative of the available applications for each method type listed. Each major method category is discussed in the following sections: metric-based methods (Section 3.2), hypothesis-testing statistics (Section 3.3), trend analysis (Section 3.4), and multivariate analysis (Section 3.5). Summary tables for each method are located at the end of each section.

### **3.2 Metric-Based and Index Approaches**

Metric-based ecological evaluations are a class of methods that focus primarily on the structure, the health or quality, integrity or “balance” of the aquatic community, and have played an important role in aquatic impact assessments for many years (Simon 1998, Davis 1995). Although some of the earliest indices focused upon a single factor or “metric” (e.g., a diversity index), the recent indices integrate several different aspects of ecosystem health, such that the community is evaluated through a series of metrics that are integrated into a single index value. For example, the sum of 10 different metrics will yield a composite Invertebrate Community Index (ICI) score for a site, which is then compared to ICI scores for an appropriate “reference” area to determine if the site has been impacted (Ohio EPA [OEPA] 1989).

The most commonly used multi-metric indices have become inextricably linked with “bioassessments” or bioassessment-type protocols. A bioassessment is an evaluation of the biological condition of a water body using direct measurements of resident biota in surface waters (U.S. EPA 1990). Several bioassessment methods are being used in the United States (Karr 1981, U.S. EPA 1996b, U.S. EPA 1997b) and although the community component(s) used in the methods may differ (e.g. fish, invertebrates, algae), each index attempts to measure biological integrity—that is, “The ability to maintain a balanced, integrative, and adaptive community of organisms having a species composition, diversity and functional organization comparable to that of the natural habitat of the region” (Karr and Dudley 1981). An important distinction to make here is the difference between “pristine” and “natural” (or at least disturbed) conditions. There are no pristine areas (without human impacts) in the United States (Omerick 1995). Current “natural” conditions can mean a variety of things. In the context of biological integrity and biocriteria, the “least disturbed” regional areas are most suitable as reference areas (Omerick 1995) and are representative of contemporary natural conditions.

Multi-metric bioassessment protocols have been published by the U.S. EPA for wadeable streams and rivers (U.S. EPA 1989; Revision 1997b). These methodologies were in part developed to detect impacts in aquatic communities caused by water quality perturbations. Consequently, some of the individual metrics focus on pollution tolerance and are predominantly measures of acute or chronic toxicity or eutrophication. Although suitable for the development of biocriteria on water bodies that receive municipal or industrial wastewaters, to date multi-metric approaches have not been widely used or validated for detection of potential impacts associated with the operation of once-through cooling water systems (i.e., thermal and mechanical impacts). Moreover, the guidance currently available for larger systems (lakes, estuaries) is relatively new and/or only draft. There are a number of states that have developed the metrics and scoring criteria necessary to apply the approaches to larger rivers, however, impounded systems must be evaluated separately from free-flowing ones (OEPA 1989). Adaptations of multimetric evaluation approaches are more limited for lakes and

impoundments or estuaries where the majority of power plants are located and, thus far, are more region-specific (e.g., Hickman and McDonough 1996, Thoma 1998).

EPA has released guidance for lakes and reservoirs (U.S. EPA 1998b) and a preliminary update of the guidance for streams and wadeable rivers (U.S. EPA 1997b). EPA will complete technical guidance documents for development of biological assessment methods and criteria for all water bodies:

- Estuaries and near coastal waters (1999)
- Streams and wadeable rivers update (2000)
- Statistical guidance on biological data analysis (2001)
- Coral reefs (2001)
- Large rivers (2002)
- Wetlands (2002)

Metric and index calculations are based upon site-specific field data. Most metrics are numeric descriptions of components of an aquatic community; variability and statistical power have been addressed to varying degrees by different researchers and practitioners. Multi-metric approaches are a combination of qualitative, semi-quantitative, and quantitative techniques, depending upon the field sampling design and the metrics used.

Critical to the conduct and interpretation of biological assessments is the comparison of site data against an appropriate “reference” area. The expected conditions or “biological criteria” that are used as the reference condition are derived from intensive study or knowledge of water bodies within the region. However, establishing ecoregion-specific biocriteria can be a very costly and time-consuming one time task, aided where adequate historical data is available. Moreover, there can be a wide variety of habitat types within each ecoregion that will influence the aquatic community expected to occur (Simon and Lyons 1995), and therefore the interpretation of the data. To be most effective, scoring criteria need to be established for each habitat type within each ecologically significant physiographic region (e.g., coastal plain streams vs. Piedmont streams) (Hughes 1995). Ohio EPA (OEPA 1989), for example, has addressed this problem within each ecoregion by establishing different biological expectations for headwater areas versus larger wadeable and boatable waterways, but the method was derived only after many years of research. One final issue in developing site or ecoregion-specific criteria is that suitable unimpaired sites may not be available in an ecoregion or the only sites available may have some impairment in some metrics. Where some impairment occurs in the reference sites, the analysis loses sensitivity or best professional judgement and/or historical data can be utilized (the latter removing

any loss of sensitivity). When the only available reference site is on a different waterway, issues of comparability of habitat between reference and test locations can arise.

The use of multimetric approaches, therefore, leaves researchers with several important considerations:

1. If only a broader set of community expectations have been published (e.g., a large geographic region versus a specific ecoregion), use of reference criteria may substantially over- or underestimate impacts.
2. Where ecoregion-specific reference conditions and scoring criteria exist, it may be appropriate to use those criteria verbatim in an impact assessment. However, it must be noted that this assumes habitat conditions in the vicinity of a particular plant are properly reflected in the regional reference condition.
3. Where ecoregion-specific expectations are not established, or where regional criteria do not adequately reflect the site-specific habitat characteristics, researchers must decide whether to use the established criteria, or whether site-specific criteria need to be developed.
4. Reference conditions must be established based upon the question being addressed. In some cases, the question is how well the community at "site b" compares to the best obtainable community for that ecoregion and habitat; in other cases, the question is how well the community at "site b" compares to that at a selected control site (known to not be best obtainable).

The latter may be both more costly and complex (on a one time or infrequent basis). Developing a sound database from which regional expectations can be derived is the only way to effectively use biocriteria.

One other consideration for researchers using multimetric (or other retrospective) approaches for impact assessment is sampling design. If a bioassessment needs to measure both near- and far-field effects in the vicinity of an outfall, the sampling design for the biosurvey must be rigorous enough to be able to detect the zone of impact or influence. Stations that are too far apart or in widely variable habitats will make interpretation difficult and potentially result in a poorly defined impact zone. Another consideration is that approaches using fish alone cannot discriminate between multiple perturbations in a relatively small area. It must often be recognized that a measured instream effect could be caused by a variety of influences in addition to the specific source being investigated. Chronic water quality problems within a watershed, other point source or non-point source inputs, commercial fish harvests, and impoundments can all influence aquatic communities, and a community-based approach may not be discriminating enough to distinguish between these influences, particularly in the far-



field. Different multi-metric approaches utilize different sized sampling areas. Some approaches lend themselves to far-field analysis. A given approach cannot evaluate near-field impact areas which are smaller in size than the sample area required. Complex impact assessments in relatively disturbed watersheds can have the added problem of a lack of an appropriate reference site within the same watershed.

The use of biological indices in the regulatory context is a relatively new development and the approach has not yet been adopted in every state (Adler 1995, Southerland and Stribling 1995). State bioassessment programs exist, to some degree, in 41 states, but few of these have developed ecoregion-specific biocriteria and fewer still have quantitative biocriteria in their water quality standards (U.S. EPA 1996b). Most rely upon the existing narrative water quality standard(s) that require a particular water body use(s), or maintenance of a balanced indigenous community. Some states have begun to require the use of biocriteria in the assessment of power plant impacts as a requirement for continuance of thermal variances (e.g., EA 1997b for Allegheny Power). Most states utilize benthic invertebrates for water quality monitoring, although usage of fish assemblages in monitoring programs is increasing (Yoder and Smith 1998). As more states develop biocriteria, it is expected that bioassessments and multi-metric indices will become a more common assessment technique. However, to be a useful tool, these biocriteria must be developed on a sufficient multi-year baseline in order to reflect natural variation due to annual variability in natural aquatic communities (Yoder and Rankin 1995, Reash 1995).

U.S. EPA has recently reviewed the application of biocriteria throughout the United States and published the results in Summary of State Biological Assessment Programs for Streams and Rivers (U.S. EPA 1996). Earlier work by the Agency compiled a fairly comprehensive list of references related to biocriteria development and bioassessment application throughout the United States (Stribling et al. 1996). Although neither document is completely current, both are recommended as a starting point for research into local (regional) bioassessment trends and biocriteria development. U.S. EPA is also in the process of revising its rapid bioassessment guidance for streams and small rivers.

The following sections introduce the concept of multimetric evaluations in detail beginning with description of the "Index of Biotic Integrity." Other fish community indices are described in Section 3.2.2. Because this manual is designed to focus on interpretive techniques, specific field sampling methods and outputs are not included here but are detailed in the primary references.

### **3.2.1 Index of Biotic Integrity (IBI)**

The IBI, as developed and detailed by Karr (1981) and Karr et al. (1986), is a broadly based fish community assessment index firmly grounded in fisheries ecology (Table 3-1). The index was originally developed for low-gradient streams in the Midwestern United States (Karr 1981), but has since been modified and adapted for

other regions throughout the United States (U.S. EPA 1996b) as well as Canada (Steedman 1987) and parts of Europe (Oberdorff and Hughes 1992). Of the available indices of environmental stresses based on fish, Fausch et al. (1990) concluded that Karr's IBI produced the most consistent, reliable, and biologically meaningful results. The IBI is sensitive to various forms of degradation and has been found to produce reliable and accurate assessments of known degradation in water quality and habitat structure. The IBI incorporates the zoogeographic, ecosystem, community, and population aspects of fisheries biology into a single ecologically-based index of the quality of a water resource. The original IBI is a non-tidal freshwater assessment technique. However, coastal states such as New Jersey and Massachusetts are exploring the inclusion of tidal freshwater and brackish species in their adaptations of the IBI. Larger river adaptations have been developed in Ohio, Missouri, and Indiana (Simon and Lyons 1995). Lake and reservoir adaptations are also under development in several areas (e.g., McDonough and Hickman, 1998, Thoma 1998, Jennings et al. 1998, Whittier 1998).

The original IBI includes a range of attributes of fish assemblages and incorporates site-specific data into 12 metrics grouped in 3 categories:

Category	Metric
Species Richness and Composition	Total number of native fish species
	Number and identity of native darter or benthic species
	Number of sunfish or pool species
	Number of sucker or long-lived species
	Proportion of intolerant species
	Proportion of green sunfish or tolerant species
Trophic Composition	Proportion of individuals as omnivores
	Proportion of individuals as insectivores
	Proportion of top carnivores
Fish abundance and condition	Number of individuals in sample
	Proportion of hybrids or exotics
	Proportion with disease/anomalies

Fish community data are collected and the computed values for each of the 12 metrics are evaluated in light of what was found at a control site; or what has been found or what might be expected at an un-impacted (or least disturbed) reference site (i.e., where human influences have been minimal) located on a stream of comparable habitat (including size) within the same or similar geographic region. In the case of the basic IBI calculation, the computations are simply a proportion of the total at the test station in comparison to the reference or control condition(s).

A numeric rating is assigned to each metric based on whether its evaluation (proportion) deviates strongly, deviates somewhat, or approximates expectations. The expectations for each metric vary. Generally, most species richness metrics (except for proportion of green sunfish) and the number of fish in the sample are expected to be >67% of reference for the highest score (5) and <33% of reference for the lowest score (1). Most other metrics have lower expectations for the highest rating: the proportion of insectivores and top carnivores receive scores of 5 if 45% or 5% of the reference conditions (respectively) are measured at any site. Some metrics (proportion of green sunfish, proportion of omnivores, proportion of hybrids/exotics, and proportion with diseases/anomalies) have inverse scales reflecting that lower proportions of individuals in these categories reflect better fish community health. For these metrics, the best scores are received for (respective) values of <10%, <20%, 0%, or <1% of the observed community at a test site (U.S. EPA 1989).

Each metric provides information about a specific community attribute, and collectively the metrics characterize the underlying biotic integrity of a particular station. Karr et al. (1986) emphasize that biotic integrity is not a function of the metrics, but rather the values of the metrics are functions of the underlying biotic integrity. The sum of the 12 metrics yields an overall score for each sampling station. High scores (58-60) indicate stations with balanced fish communities and little or no perturbation and are rated excellent, whereas lower scores (12-22) indicate stations of very poor quality with few fish and poor trophic structure. Between the excellent and poor integrity classes, fish communities can be categorized as good (scores of 48-52), fair (scores of 40-44), and poor (scores of 28-34). Generally, the number of species and the number of intolerant species decreases and the number of tolerant forms increases as the total IBI decreases (U.S. EPA 1989). Therefore, the lower integrity classes generally reflect less community balance and higher numbers of tolerant forms. IBI metrics are meant to assess the health of the naturally occurring communities which, in principle, does not include stocked species. Also, the introduction of exotic species, particularly those that can thrive and reproduce (e.g., common carp), confounds the assessment.

Defining the expectations (or reference conditions) for a region has proved to be the most challenging aspect of utilizing the IBI and other multimetric approaches. In areas where aquatic conditions differ significantly from those of Midwestern streams, the metrics utilized by Karr and his associates may be insensitive or meaningless to local conditions (Leonard and Orth 1986). Ecoregion- and habitat-specific scoring criteria are,

therefore, essential. If determined to be necessary, generating scoring criteria requires that fisheries community data be gathered from a variety of sites within the region and analyzed to establish a series of "expectations" for each metric. Ideally, data should be collected over several years to reflect a range of hydrologic conditions. The expectations (criteria) are derived statistically, which makes this process both data and time intensive.

Once reference conditions and scoring criteria are known, however, the IBI is a hierarchical process that first requires the investigator to identify all fish species that could potentially occur in the study stream or watershed. Each of these species must be assigned to a unique trophic guild (feeding group) and tolerance class based on the literature and/or professional judgment (Table 3-2). The applicability of the metrics must be evaluated based on stream size and/or fish fauna of the region. Any changes to the metrics should be made by an experienced fisheries scientist familiar with the methodology and the local fish fauna, and should retain the ecological basis and intent of the original metrics.

The sample collection and data tabulation phase of the IBI requires the investigator to obtain a representative sample of the fish community at a particular location and to tabulate the values for each metric. Collection methods/gear must ensure the quality of the data, and must be designed to accurately reflect the fish community present in a stream at a specific time. Sampling procedures must be capable of sampling all species in proportion to their relative abundance. Although not without bias, electrofishing is considered to be the most comprehensive and effective single method currently available for collecting stream and river fishes (OEPA 1987; U.S. EPA 1989).

Metric modifications are necessary in some systems because the ichthyofauna of various ecoregions differs from the primary taxonomic groups of fishes and fish assemblage structure in Midwestern streams for which the IBI was developed (i.e., darters, suckers, and sunfish). In regions far from the Midwest, intensive baseline research (e.g., maximum species richness line determinations as per Fausch et al. 1984) is necessary to define expectations (i.e., scoring criteria) for species richness and composition of the study region. The calibration of metric expectations requires a base of fish community data from similar size streams within the same geographic region that represent "minimally-impacted" or "excellent" conditions. Where local scoring criteria do not yet exist in the literature/regulations, individual metrics can still be calculated but metric scores and final integrity classes cannot be assigned. Individual metrics can be compared among stations to make inferences about fish community health; however, a holistic score that can be related to the quality of reference or control conditions is not possible.

The initial step in the IBI data tabulation phase involves the assignment of each fish species encountered to its appropriate trophic guild and tolerance class. Many fish of the United States have been classified by trophic and tolerance group in the literature as

part of previous IBI assessments. Examples include U.S. EPA 1983; Karr et al. 1986; OEPA 1987; Allen 1989; Plafkin et al. 1989; Barbour et al. 1995; Hickman and McDonough, 1996; and Thoma, 1998. In most cases, the literature is in agreement as to trophic and tolerance designations. Some fish species do, however, occupy different trophic levels and display different tolerances in varying ecoregions. Where sources disagree, the classification identified by the majority of sources or the classification taken from the most similar geographic region is generally selected. For examples of sources for metric alternatives, see the newest U.S. EPA Guidance for Streams and Rivers (U.S. EPA 1997b).

The second step in the data tabulation phase requires the evaluation of IBI metric suitability for the study region. Early reviews of the IBI methodology recognized that certain metrics developed for Midwestern streams were poor measures of the intended community attribute where the dominant fish taxa differed substantially from typical Midwest communities (Leonard and Orth 1986). Barbour et al. (1995) provides a comprehensive synopsis of the appropriate metrics in various regions which has been included in Table 3-3.

The third step involves assessing the metric results at various sampling stations with respect to the expectations for that metric and assigning a score of 1, 3, or 5 based upon regional expectations. For example, if the total number of fish species found at a site met the expectations for a stream of that order within the ecoregion, the station would be assigned a score of 5; if the number of species were slightly lower than expectations, the site would be assigned a score of 3; if few species were found, it would like receive a score of 1. After scores are assigned to each metric, the individual scores are summed by site and the site is assigned a standard integrity class (ranging from excellent to very poor) based upon the total score, as described previously.

### **Application**

Multi-metric fish evaluation techniques, like the IBI, currently have limited but growing use in assessing the condition of fish communities in the vicinity of power plants. The current limitations are predominantly driven by a lack of ecoregion-specific scoring criteria and/or suitable reference sites. As more states develop databases of reference conditions, multi-metric approaches such as the IBI will gain wider acceptance as a regulatory tool.

As with any retrospective technique, it may be difficult (or in some cases impossible) to identify the cause of a measured instream response, particularly where biological integrity is compromised throughout a watershed. However, various indices may be sensitive enough to demonstrate whether a particular facility is causing additional impairment relative to control conditions, which may be sufficient to address the Section 316 criteria of “no adverse impact” and “balanced indigenous populations.” In

cases where a limited or patterned number of metrics are affected, there is often indication of cause, and it may be possible to demonstrate cause/effect relationship.

States such as Ohio, which adopted the biocriteria approach to water quality management early, have developed specific biocriteria for various ecoregions, sizes of water bodies, and water use types. Ohio EPA (1989) has divided the state into five ecoregions which reflect the prevailing topography and unique IBI criteria developed for each ecoregion. For each ecoregion, there are three major aquatic life use categories: Modified Warmwater (modified channel, mine affected, or impounded), Warmwater Habitat, and Exceptional Warmwater Habitat. Within each aquatic life use category (and subcategory for modified warmwater) individual IBI criteria have been derived depending on whether the site is a headwater, wadeable (larger) stream, or must be sampled by boat. A similar technique was also used to develop Index of Well Being (Iwb) and Invertebrate Community Index (ICI) criteria. Ohio's work has been viewed as a model for biocriteria development in other states.

### **3.2.2 Other Fish Community and Population Indices**

#### 3.2.2.1 Family Level Ichthyoplankton Index Methods ( $I^2$ )

Similar to the IBI for adult/subadult fish communities, the  $I^2$  focuses on the youngest life stages of (larval) fish (Table 3-4). It utilizes ichthyoplankton data at the family level of identification to assess water quality. Because younger life stages are often more sensitive to pollutants and other habitat degradation (U.S. EPA 1993), the  $I^2$  may be among the most sensitive indices in some areas. The  $I^2$ , as currently proposed by EPA (U.S. EPA 1993), functions as a screening tool to assess habitat degradation, requiring only a single sampling effort. The 11 metrics for  $I^2$  fall into three basic categories:

1. Taxonomic Composition:
  - (1) Total number of Families
  - (2) Number of sensitive species
  - (3) Equitability/Dominance
  - (4) Family Biotic Index
2. Reproductive Guild:
  - (5) Percent Non-Guarding Guild A.1 and A.2
  - (6) Percent Guarding B.1 and B.2
  - (7) Percent Bearers Guild C.1 and C.2
  - (8) Percent Simple Lithophil Mode Reproduction
3. Abundance, Generation Time, and Deformity:
  - (9) Catch per unit effort

- (10) Mean generation time
- (11) Percent Deformity or Teratogenicity (embryonic anomalies/malformations)

Included in the taxonomic composition category is a family biotic index similar to the Hilsenhoff Index (Hilsenhoff 1987) utilized for benthic evaluations. A family biotic index incorporates tolerances to organic enrichment. Tolerance values as well as detailed reproductive style data are included in the guidance for this method (U.S. EPA 1993).

The expectations for most metrics are drainage size and ecoregion dependent, which is one of the largest limitations to this method's use at this time. In addition to a knowledge of ichthyoplankton taxonomy, an advanced knowledge of the reproductive cycles and ecology of the fish community in the area is required to use this methodology. Currently, the  $I^2$  metrics are only developed for freshwater systems.

### 3.2.2.2 Reservoir Fish Assemblage Index (RFAI)

The Tennessee Valley Authority has developed a modification of the IBI to help assess the condition of the water resources in the Tennessee River valley reservoirs (Hickman and McDonough 1996). The researchers developed reference conditions for reservoirs of various size and function (run of river and tributary storage) (Table 3-5) as well as for major habitats within the reservoirs. Factors such as area of reservoir (forebay, inflow, transition area) and ecoregion were also considered in reference condition development. Sampling was conducted in the littoral zone (by electrofishing) and benthic limnetic zone (by gillnetting) and a combination of the two gears was deemed most appropriate for monitoring studies. The authors noted that fairly intensive sampling is necessary for reference condition development. The metrics chosen were based upon those most suitable for a river-reservoir system and need to be tested/validated in other such systems before the method becomes widely applied as a monitoring tool (Hickman and McDonough 1996). Twelve metrics within five basic categories have been proposed for this methodology:

1. Taxon richness and composition:
  - (1) Total number of species
  - (2) Number of *Lepomis* sunfish species
  - (3) Number of sucker species
  - (4) Number of intolerant species
  - (5) Percent individuals as tolerant species
  - (6) Percent dominance (numerical percentage of most common species)
2. Trophic Composition:
  - (7) Number of piscivorous species
  - (8) Percent of individuals as omnivores
  - (9) Percent of individuals as insectivores

3. Reproductive composition:
  - (10) Lithophilic spawning species
4. Abundance:
  - (11) Total number of individuals
5. Fish Health:
  - (12) Percent with diseases, parasites, or anomalies (including natural hybrids)

If this method is found to be useful in other systems, it has the potential to be used in the evaluation of potential power plant impacts because it evaluates one of the large water body-types on which power plants are located.

### 3.2.2.3 Index of Well Being (Iwb)

The Iwb, or Composite Index, is not a multimetric technique, but is discussed in this section because one of its most widely used modifications shares some of the concepts and data of the IBI (Table 3-6). The index was originally developed by Gammon for the Wabash River in Indiana (Gammon 1976, Gammon et al 1981) and subsequently modified for other river systems in Indiana (Gammon 1980, Yoder et al. 1981). It is called a composite index because it incorporates four community measures into a single index: numbers of individuals (N), biomass (W), and Shannon Diversity index (H) (Section 3.2.6) for both numbers and weight.

Modified Index of Well-Being (Iwb):

$$Iwb = 0.5 \ln N + 0.5 \ln B + \bar{H}(\text{no.}) + \bar{H}(\text{wt.}) \quad (\text{eq. 3-1})$$

where:

N= relative numbers of all species excluding species designated "highly tolerant"

B= relative weights of all species excluding species designated "highly tolerant"

$\bar{H}(\text{no.})$  = Shannon diversity index based on numbers.

$\bar{H}(\text{wt.})$  = Shannon diversity index based on weight

Individually, these community measures are inconsistent in the prediction of environmental perturbations (OEPA 1989). When considered together, however, these measures can compensate for each other in the interpretation of community balance. For example: high biomass (W) can be driven by the presence of one or two tolerant



species in very large numbers. However, the Shannon Diversity component ( $H$ ) tends to compensate for this by factoring in the lower diversity at a site (OEPA 1989).

The Iwb can be applied to a variety of fish community data to derive a relative index of fish community balance at each test site. The input data generally come from basic summary statistics from a fisheries biosurvey conducted by electrofishing. Interpretation of the Iwb is qualitative and reference site information is necessary to make judgments regarding the level of perturbation at a site compared to other areas. Regional and habitat-specific criteria for the Iwb are, therefore, necessary to properly use the Iwb as a regulatory tool.

One problem of applying the Iwb is sensitivity to nutrient enrichment. In adversely affected (e.g., nutrient enrichment) areas where fish communities demonstrate high abundance and biomass, but species richness is moderate, the Iwb tends to be relatively high and not reflective of the actual community condition. To compensate for this problem, OEPA (1989) developed a “modified Iwb” (mIwb). Because tolerant species are the last to disappear in a stressed system, and the first to increase disproportionately in impaired conditions, Ohio EPA’s modification uniformly eliminates tolerant species from the calculation. Based upon the same tolerance classifications that were derived for Ohio EPA’s IBI, the numbers and biomass of all tolerant species are eliminated from the calculation. Tolerant species are still considered in the two Shannon Index calculations so the relative species richness is not lost to the interpretation.

Application of both the Iwb and the mIwb on fisheries data from the Ottawa River Basin in Ohio demonstrated the mIwb was more sensitive to a variety of environmental stressors and was, therefore, a better regulatory tool (Ohio EPA 1989). Because Ohio EPA had a large database of fish distribution information, state-specific tolerance values for all fish species were derived. When regional differences in tolerance to perturbations can be factored out in this manner, tolerance-based metrics become much more sensitive and predictable to regional conditions.

The Iwb and mIwb have not gained wide regulatory acceptance outside of Indiana and Ohio, respectively, and their use at utilities would be limited to those states. However, it is possible that other states may develop the index in the future. The IBI has gained wider acceptance within the regulatory community and is the method of choice for most fish community assessments where scoring criteria and reference conditions are available (Simon 1998).

#### 3.2.2.4 Sport Fishing Index

One multi-metric technique currently being utilized by the Tennessee Valley Authority (Hickman 1997) is the Sport Fishing Index (SFI) (Table 3-7). Although the method is unpublished in the peer-reviewed literature, it merits mention here because it extends the multi-metric concept to the population level for use by fishery managers, as

compared to community-level methods that are used almost exclusively by water regulators and the water quality regulated community. The index takes into account quality aspects of game fish populations in reservoirs, as well as creel information on fishermen success. Fish population quantity (catchable-sized fish only) is measured using standard collection techniques: spring electrofishing (bass), fall overnight trapnetting (crappie), or experimental gillnetting (walleye/sauger and channel catfish).

Population quality measurements consist of five community aspects which are standard fisheries management calculations: Proportional Stock Density (PSD), Relative Stock Density of Preferred-sized fish (RSDP), Relative Stock Density of Memorable-sized fish (RSDM), Relative Stock Density of Trophy-sized fish (RSDT), and Relative Weight (Wr). Each aspect makes up 20 percent of the population quality rating and is scored either 1, 2, or 3 (total of up to 15 for population quality), based upon literature-derived scoring criteria for these individual parameters. Species-specific catch-per-unit-effort (CPUE) from fisheries collections and creel surveys are also scored on the 5-15 scale based upon 5 years of multiple agency data. Creel information is supplemented with bass fishing tournament results when measuring black a bass fishing quality. Fishing pressure (hours/acre) is used as a measure of fishing quantity and scored on the same scale. Some of the metrics used to calculate the SFI are detailed in Section 3.6.

The resulting SFI provides a relative measure of fishing quality within a reservoir for each species targeted by anglers. It is expected that the index will be useful to not only anglers and fishery managers, but to water resource managers as a population assessment tool as well.

#### **3.2.2.5 Fish Assessment Protocols for RBP**

The Rapid Bioassessment Protocols (RBP) developed by the US EPA include specific fish biosurvey and data assessment techniques. The original EPA guidance for fish assessments (US EPA 1989) was structured as two Protocols (IV and V) where Protocol IV was a screening-level assessment and Protocol V was a detailed fish community assessment. These techniques, particularly Protocol V, are still widely used and are detailed in Section 3.2.3. The newest guidance for the RBP (U.S. EPA 1998b) still includes fisheries assessments much like the older Protocol V guidance. Details on the new protocol are also included in Section 3.2.3.

### **3.2.3 Rapid Bioassessment Protocols (RBP)**

Rapid bioassessment is a specific bioassessment technique that integrates biosurvey results and metrics calculations with a multi-metric evaluation of the habitat. The purpose is not only to evaluate aquatic community health/balance, but also to make inferences about the role of habitat in the observed condition of the aquatic community. By factoring out habitat constraints, the role of environmental perturbations in the

observed community health can be better defined (U.S. EPA 1989). As originally developed, the RBP provides a rapid, holistic method for assessing aquatic community health and, thereby, assessing the prevailing water quality of a system. The methodology was developed to assess streams and small river systems but is being adapted by various resource agencies for lakes, larger rivers, and even estuaries (OEPA 1989, Weisberg et al. 1997, U.S. EPA 1998b).

The original guidance (U.S. EPA 1989) identified five basic protocols. Protocols I-III were benthic community assessments; Protocols IV and V were fish community assessments. Protocols I and IV are screening tools that generate very limited data compared to Protocols II, III, and V. In the most recent guidance (U.S. EPA 1997b), these protocols have changed somewhat. The following section reflects the proposed updated protocols.

The original RBP Protocols II and III for macroinvertebrates are no longer differentiated under the current proposed system. As currently proposed, there is a single analytical processing protocol that is coupled with two distinct field sampling protocols. The analytical protocol is summarized in Table 3-8.

*Single Habitat (Field Sampling) Approach:* for benthic macroinvertebrates includes qualitative sampling of benthic macroinvertebrates from randomly selected riffle and run areas within a 100 meter sample reach. Two to three kicks into a standard kicknet are made at various velocities within the sampling reach and composited for laboratory processing. This protocol is meant for areas where cobble substrates dominate the instream habitat.

*Multihabitat (Field Sampling) Approach:* for benthic invertebrates is meant to be used in streams where cobble is not the dominant bottom type and/or there is a wide variety of habitat types. The distribution of habitat is grossly mapped in a 100 meter stretch of stream. The number of “kicks” within each reach is proportional to the percentage of that habitat type within the sample reach. All samples are composited to a single sample for processing.

In the laboratory, a standard subsample of the first 100 organisms is processed. Although only the first 100 are identified, the method requires considerable expertise in invertebrate taxonomy. Organisms are, therefore, preserved and returned to the laboratory for identification and enumeration. This more detailed approach (relative to the field sorting conducted previously) provides important information about taxa within families. Although taxonomy can be conducted to any level, genus/species level is recommended. Because not all species within a family are as tolerant or sensitive to water quality degradation, the more detailed taxonomy helps to differentiate the levels of impairment at various sites.

The appropriate metrics for data analysis will be ecoregion-specific and the reader is referred to Table 3-9 or the Draft Revision of the Protocol for the detailed descriptions of the various options. The metrics are basically broken out into four categories:

1. Richness measures
2. Composition measures
3. Tolerance measures
4. Trophic measure

Relevant metrics are chosen based upon the ecoregion and character of the stream. In the newest guidance descriptive statistics are used to characterize metric performance and the most robust metrics are chosen for examination. Once selected, the metrics for each site are compared to those of a reference site or ecoregion-specific criteria and scored based upon the expectations for unimpaired communities in the region. The scoring is metric dependent and scores are summed for a final index to be compared to habitat conditions. Final impairment determinations are made based upon the total possible score. This newer approach makes multimetric determinations much more flexible and robust.

*Biological Reconnaissance (BioRecon)*: replaces the previous RBP I as the preferred method for screening large areas to identify potential problems (Table 3-10). It would be the first step in identifying areas that need more in-depth study/monitoring. Similar to the more in-depth sampling techniques, this method would cover 100 meters of stream. However, fewer “kicks” would be done in each flow regime or habitat type. Samples can be processed in the field or the lab and generally less in-depth taxonomy is sufficient for site screening. Fewer metrics are necessary, and analysis is based predominantly on richness measures.

*Fish Assessments*: utilize a standardized field sampling approach with calculation of a region-specific IBI for data analysis (Table 3-1) (U.S. EPA 1989). Electrofishing is the preferred sampling technique. Standardized electrofishing reaches are established based upon the size of the water body (e.g., 100-200 meters for small streams and 500-1,000 meters for larger rivers). For more rigorous quantification, block nets can be used at the ends of the sampling reach. The field collection is, however, qualitative in that no depletion sampling is performed. The fish community data are analyzed using the IBI approach, described previously. However, the metric selection and application technique recommended for macroinvertebrates is also recommended for IBI assessments under the new RBP guidelines.

The *Habitat Assessment* component of the RBP is also a multi-metric evaluation that came originally from the work of Ball (1982) and Platts et al. (1983). The approach

involves the relative scoring of a variety of instream and near-stream physical features based upon their value as fish or benthic habitat. The method has been updated for the newest guidance to address shortcomings in the original method and acknowledge some regional variations that have been developed since the newest guidance was published. The original method proposed in U.S. EPA (1989) was modified by Barbour and Stribling (1991) to differentiate between high and low gradient streams and was adopted for the newest guidance. The differences between the two acknowledge the importance of pool habitats and channel sinuosity in lower gradient streams. Ohio EPA has also adopted a region-specific modification known as the Qualitative Habitat Evaluation Index (QHEI) which was described by Rankin (1991). As an example, the habitat features recommended for high gradient streams and preferred conditions are outlined below:

<b>Habitat Parameter</b>	<b>Preferred Conditions</b>
1. Epifaunal Substrate and Available Cover	stable, varied features
2. Embeddedness	little accumulation of fine materials
3. Velocity/ Depth Regime	Stream-type dependent. Generally more flow is better as long as it supports a variety of macrohabitat types.
4. Sediment Deposition	little alteration of stream bed
5. Channel Flow Status	water fills most of channel
6. Channel Alteration	minimal channelization
7. Frequency of Riffles	riffles relatively frequent
8. Bank Stability	Minimal evidence of erosion or failure
9. Vegetative Protection	Greater than 90% coverage with native vegetation
10. Riparian Zone Width	Riparian zone > 18 meters

Within each category, habitat quality is assigned a numeric rating based upon a scale that varies to reflect the importance of the category in overall stream habitat quality. Primary features are rated on a scale of 0-20; Secondary from 0-10. General descriptors of habitat quality (poor, marginal, suboptimal, optimal) are assigned to each category depending upon the habitat score. Following this method, the habitat available within

the reach that was sampled for a biosurvey can be evaluated and compared to the observed condition of the aquatic community (U.S. EPA 1989).

The goal of bioassessment is not only to identify sites of impaired biological condition but also to identify the potential stressor that may be causing the impairment. Integrating habitat quality assessments with bioassessment results enables the researcher to factor out potential habitat limitations as a factor for the noted impairment. The integration approach put forth by U.S. EPA (1989) is still recommended. Biological condition plotted against habitat quality is still widely used to differentiate between habitat-driven and pollutant-driven biological impairment. The placement of the data point in proximity to the standard curve indicates whether the biological condition is more likely a result of limited habitat or water quality degradation. An example of this integrated result is provided in Figure 3-1. This graphic is taken from a case study on a coastal New England river where both point source and non-point source perturbations were expected to occur. It demonstrates that, in most cases, poor habitat was the most likely causal factor for poor benthic community health. However, at several stations water or sediment quality was contributing to poor community balance. This integrated approach helped researchers to identify areas where more detailed study of possible contaminant inputs was necessary.

### **RBP Application**

Bioassessment techniques, in general, have been gaining popularity as regulatory tools (Adler 1995, Southerland & Stribling 1995). The newest guidance (USEPA 1997b) is not yet being generally applied in many areas, so discussions of applicability must focus on previous applications of Protocols I-IV. RBP Protocols I and IV were best used to screen a large number of sites for water quality assessment and management but are insufficient for detailed impact assessment. The BioRecon will fill that role for benthics (Protocol I) when the new protocols are more widely utilized. The screening protocols would have limited use for §316 (a) or (b) assessments because they are not robust enough to support detailed impact analysis. RBP Protocols II, III, and V are currently in use throughout the United States for surface water quality monitoring. As mentioned previously, some utilities are being required to assess community balance as a requirement of NPDES permit renewal. Because some of the metrics currently being used in the RBP are based upon pollution (toxicant or nutrient) tolerance, the technique may be limited in situations where thermal inputs are the only known stressor. With suitable reference sites (near field), demonstrations of community balance in proximity of a power plant discharge could be made with this technique or the newly revised benthic and fish protocols.

A management decision involved in the use of all multimetric techniques is the interpretation of impairment. The original Agency guidance (U.S. EPA 1989) implies that communities demonstrate some impairment if study site metric values are not at

least 80% of the reference site score for benthos, and 67% of the reference site score for fish. The newest guidance suggest 75% of the reference condition (U.S. EPA 1997). For use in Clean Water Act (CWA) §303d listings, U.S. EPA has been suggesting 67% as the definition of impaired streams, although some states believe that this is too stringent (West Virginia 1998). Where regional criteria are available, basic statistical comparisons can be made to demonstrate impairment (Bode and Novak 1995).

One consideration with the older higher level (Protocol III and V) evaluations and the newer guidance is that they rely upon correct identification of resident species to the lowest practical taxon for maximum sensitivity (U.S. EPA 1989, U.S. EPA 1997). In some cases, particularly in areas of tremendous benthic or fish diversity, properly qualified experts are, therefore, required to maximize the sensitivity and accuracy of the results. Poor design of the biosurvey for the area (e.g., improper station locations, inappropriate season sampled) can completely negate the results of the study (U.S. EPA 1997). Multi-metric assessment techniques are data interpretation tools and the “rapid” techniques make data interpretation simpler, but any data interpretation technique is only as good as the data on which it is applied. Waterbody conditions and available habitats need to be carefully considered in designing and implementing any sampling program (U.S. EPA 1997).

### **3.2.4 Other Benthic Community Indices**

Benthic communities are good biological indicators of environmental or anthropogenic stress because most species have limited mobility and are unable to avoid many types of adverse conditions (Gray 1979). Many benthic organisms live in sediments which can preferentially accumulate contaminants (depending on the composition). Many benthic species have relatively short life spans, and they include a variety of species with a wide-range of feeding modes, trophic guilds, and physiological tolerances (Pearson and Rosenberg 1978; Rhoads et al. 1978). Environmental and anthropogenic stresses are, therefore, reflected in local community structure. Natural habitat characteristics such as salinity, substrate, and depth also influence benthic community composition (Holland et al. 1987).

In addition to the RBP invertebrate indices (Section 3.2.3), several other indices are worth consideration in this manual. Some are single metric indices that are used in the calculation of multimetric indices (e.g., HBI and CLI) while others are region-specific derivations of the RBP and IBI techniques (e.g., ICI, B-IBI, MACS Workshop Method). Although this manual cannot detail all of the region-specific derivations of the benthic multimetric assessment techniques, the methods chosen demonstrate the wide variety of derivations currently under development for this general method.

#### 3.2.4.1 Hilsenhoff Biotic Index (HBI)

The HBI and modified HBI are widely used to calculate benthic multimetric bioassessments (Table 3-11). The methodology was originally refined by Hilsenhoff (1977) from earlier works by Chutter (1972) and later modified by Hilsenhoff (1987). It was originally conceived as a measurement of organic stream pollution using only arthropods for evaluation. The methodology basically weights the arthropod community based upon the organic pollution tolerance of each genus or species. The earlier methodology utilized a tolerance scale of 0 to 5 and was used primarily in Wisconsin (Hilsenhoff 1987). The modified index expanded the tolerance scale to a range of 0 to 10; this adds additional sensitivity to the index.

Because species tolerance values and the significance of certain species in the measurement of organic pollution varies somewhat regionally, regional adaptation/modifications of tolerance values and the index do exist (e.g., North Carolina Biotic Index, in U.S. EPA 1997b). The HBI, in its original form, is only proven to be sensitive to organic pollutants but can be used as a stand-alone assessment of organic pollution based upon a simple impairment scale detailed by the author in 1987. The scale ranges from 0 to 10.00 with the associated integrity class ranging from excellent to very poor, consecutively. As a stand-alone index, it has no known direct application as a regulatory tool and is best known for its contribution to the bioassessment protocols. Similar biotic indices have been detailed in U.S. EPA 1983.

#### 3.2.4.2 Community Loss Index (CLI)

The CLI is actually one of several similarity indices that can be used as part of a multimetric bioassessment. A detailed description of similarity indices can be found elsewhere in this manual. However, the CLI is also detailed here because it figures significantly in bioassessments. Calculation of the CLI requires a measurement of the reference condition. The technique measures species loss between the test and reference locations and the total scores are inversely related to stream conditions. Therefore, high CLI scores reflect a relatively dissimilar community (in relation to reference conditions).

The CLI and other similarity indices are not, in themselves, used as regulatory tools, but are commonly integrated into larger bioassessments. U.S. EPA 1989 lists a number of other similarity indices that researchers may use to assess similarity to reference conditions and particularly calls out The Jaccard Coefficient of Community and Pinkham and Pearson Community Similarity Index as other useful tools in bioassessments. Some of these have been integrated into region-specific multimetric assessments (Tables 3-3 and 3-9).



### 3.2.4.3 Invertebrate Community Index (ICI)

The ICI is a specific derivation of a benthic multi-metric evaluation that was developed by Ohio EPA (1989) (Table 3-12). The method is more closely related to the IBI than the RBP benthic approach in that it relies less on indices (e.g. HBI, Diversity Indices) and more on percentages of various groups of organisms. The method, therefore, provides two levels of assessment: qualitative/screening and quantitative where statistical confidence can be calculated on various community measures. The 10 metrics used to calculate the ICI are:

1. Total number of taxa
2. Total number of mayfly taxa
3. Number of caddisfly taxa
4. Number of Dipteran taxa
5. Percent mayfly composition
6. Percent caddisfly composition
7. Percent Tribe Tanytarsini midge composition
8. Percent other Dipteran and non-insect composition
9. Percent tolerant organisms
10. Number of qualitative EPT taxa

Scoring for each of these 10 metrics is from 0 to 6 points and is determined by basin drainage area at the sampling location. To support this index and derive the scoring criteria, Ohio EPA has invested substantial resources into developing species-specific tolerance values that are regionally significant (De Shon 1995). Ohio EPA has refined the numerical expectations for many metrics by assigning scoring criteria based upon drainage size. In this way, the scores for percentages of various invertebrate families or tolerance groups can be better adjusted to site-specific conditions.

### 3.2.4.4 Benthic IBI (B-IBI) for Chesapeake Bay

Researchers have struggled with developing a multimetric approach that would be applicable to the variety of physical and chemical conditions found in estuaries. The State of Maryland has monitored benthic communities throughout the Maryland portion of the Chesapeake Bay since 1984. This long-term benthic monitoring program provides a comprehensive dataset that includes communities from a variety of habitats

(Ranasinghe et al. 1994a), and has been used in conjunction with other existing datasets to develop Chesapeake Bay Benthic Community Restoration Goals (Ranasinghe et al. 1994b) and a Benthic Index of Biotic Integrity (B-IBI) (Weisberg et al. 1997) (Table 3-13). The B-IBI was an adaptation of a similar index developed by Kerans and Karr (1994) for rivers in the Tennessee Valley. The B-IBI for the Chesapeake Bay has been peer-reviewed and validated (Weisburg et al. 1997), and uses a multi-metric approach to characterize the condition or “health” of the benthic community. The B-IBI provides researchers with a tool to evaluate relative community health. Attributes of estuarine benthic communities such as diversity, abundance, biomass, proportions of pollution-sensitive and pollution-indicative taxa, and trophic feeding guilds are evaluated based upon a range of expected values derived from reference locations in habitats with similar substrate and salinity characteristics. Metrics (attributes) are salinity- and substrate-specific to minimize variability associated with habitat type. For example, the abundance of carnivores and omnivores was found to be a significant metric in higher salinity (mesohaline and polyhaline) areas, but not for freshwater tidal or oligohaline reaches. Similarly, in areas where mud is the predominant substrate at higher salinities, the biomass at various levels within the mud are evaluated whereas this is not necessary in sandy areas or areas of lower salinity (Weisberg et al. 1997).

Metrics are scored as 5, 3, or 1, depending on whether they approximate, deviate slightly, or deviate strongly from conditions at reference locations (Weisberg et al. 1997). Benthic communities with an average score less than 3 are considered stressed. This approach acknowledges the tremendous differences that salinity and substrate, in combination, can have on benthic distributions. Although regionally specific, it has gained general acceptance within the regulatory community of the Chesapeake Bay.

#### 3.2.4.5 MACS Workshop Method

A specific regional adaptation of the RBP that is currently in development is the “coastal plains” method derived by the Mid-Atlantic Coastal Streams (MACS) Workgroup (U.S. EPA 1997b) (Table 3-14). Because the RBP sampling and data analysis protocols were developed for streams of moderate gradient with hard substrate riffles, use and interpretation in areas with little gradient and sand-mud bottoms was problematic. Recognizing a need for a specific modification for the Atlantic slope coastal plain, a group of scientists and regulators from Delaware to South Carolina collaborated to develop a coastal plain technique that would be uniform over the entire ecoregion.

The assessment area for a MACS assessment is the standard 100 meter reach suggested for most bioassessments, and the reach should be wadeable with a defined channel. Sampling is qualitative, using a D-frame dipnet to jab and sweep over 20 areas, targeting the productive coastal plain habitats: woody snags, banks, and submerged macrophytes. The proportion of each type of habitat sampled should reflect its availability within the reach. Detailed notes on habitat availability and quality are also

made. Habitat assessment differs somewhat from higher gradient areas and, therefore, has a unique set of metrics and scoring scheme. The habitat metrics utilized for this method include:

<b>Metric</b>	<b>Attributes for high score</b>
1. Channel Modification	Frequent bends Natural channel (no alteration)
2. Instream Habitat	Natural variety of instream habitat features (snags, plants, undercut banks, riffles)
3. Pools	Variety of pool habitats both deep and shallow pools present
4. Bank Stability	stable no evidence of erosion
5. Bank vegetation type	dominant vegetation is shrub
6. Shading	A mixture of sun and shade 25-90% of stream shaded
7. Riparian Zone Width	No evidence of human activity within 18 meters.

A standard subsample of 100 organisms is processed in the lab to genus level. Metrics are calculated for each site separately, without utilizing reference conditions in each metric. The MACS workgroup is currently evaluating the most applicable metrics for each state but has already made some preliminary determinations. The metrics deemed most suitable for the region include:

- Taxonomic Richness
- EPT Richness
- Percent EPT Abundance
- Percent Chironomidae
- Percent Dominant Taxon
- Hilsenhoff Biotic Index

- North Carolina Biotic Index
- Community Loss Index
- Percent Non-Insect

Of these, only Taxonomic Richness has been deemed to be universally applicable across the entire region. EPT Richness, for example, may not be suitable for assessments in the southern part of the region. Similarly, the Hilsenhoff Biotic Index may be suitable from Delaware to Virginia, but the North Carolina modification (North Carolina Biotic Index) is probably more suitable for North and South Carolina (U.S. EPA 1997b). Because scoring criteria are not yet derived for this method, it currently has limited regulatory usefulness. At the present time, therefore, it is most useful as an assessment tool to qualitatively determine the magnitude of perturbations with respect to a site-specific reference area.

Many other state or region-specific derivations of multimetric assessments currently exist or are currently in development. To detail all current derivations here would be cumbersome and very likely out of date at the time of publication. It is recommended that state and local resource agencies be contacted prior to use of any of these techniques for information on the current status and appropriate metric and scoring criteria for your region. See U.S. EPA 1996b for a listing of programs and contacts for each state.

### **3.2.5 Fish Health Assessments**

Fish health and condition assessments are multi-parameter examinations of individual fish that can provide an indication of how well fish populations are supported by their habitat and water quality conditions (Table 3-15). Several of the parameters (or metrics) used in the evaluation are derived for standard stock assessment techniques (e.g., total lengths, weight, condition factors). The current U.S. EPA methodology (U.S. EPA 1993) also integrates a blood factor evaluation (hematocrit, leucocrit, plasma protein), necropsy-based organ and tissue evaluation (after Goede 1992 and Goede and Barton 1990), and a systematic cataloguing of external anomalies. Further adaptations of the method were made by Adams et al. (1993) to generate a Health Assessment Index (HAI) that accommodates quantitative comparisons of necropsy factors.

When properly conducted, fish health assessments can provide a direct measurement of the condition of a population. Length, weight, and blood factor data produce numeric results on which simple summary statistics can be run. The external and organ/tissue conditions are scored based upon the expected norms after the original methods of Goede and Barton (1990). The current U.S. EPA method does not include calculation of a single score or index. Instead, the individual condition “metrics” are cataloged individually and tracked through time for a given population. The HAI method

substitutes a value to each necropsy classification made in the field (Adams et al. 1993). By summing the total of the substitute values for individuals then deriving a mean of values for all individuals examined, an HAI value can be derived for a sample population. Because this is done for individual fish, there is enough replication for statistical analyses to be performed.

As with all retrospective methods, without a database of the expected norms or baseline conditions for a population, a health assessment is limited to providing a “snap-shot” of current conditions within a particular drainage or water body. It is often useful as a tool to identify gross problems within a population, but the greater value of the technique is its ability to track fish health over time. Where a database does exist, the HAI can be an effective comparative tool to provide a rapid assessment of general fish health in the field.

Data management of so many environmental “factors” is fairly easily accomplished with a standard spreadsheet or database software. There is a commercially available database software tailored specifically to manage fish health assessment data that is recommended by the U.S. EPA Guidance (U.S. EPA 1993).

The typical sample size for fish health assessments is 20+ individuals of the same species with individuals of the same basic size (age) preferred (U.S. EPA 1993). This provides enough data for summary statistics of reasonable power for those health factors that are directly measured. In cultured populations, obtaining the requisite sample size is relatively easy. In free-ranging wild or stocked populations, obtaining the requisite number of individuals may not be possible in some situations. Also, health assessment results can be confounded by the mobility of many fish species and their variable exposure to various stressors.

### **Fish Health Assessment Application**

Fish health assessments were developed for use in aquaculture and stock management programs (U.S. EPA 1993) but are increasingly being used to assess biological health as part of impact assessments. Recent adaptations have made them more applicable to natural systems (Adams et al. 1993, Adams and Ryon 1994). Use of this technique specifically for power plant impact assessments is only known from one area. Coughlan et al. (1996) applied the fish health assessment index to largemouth bass in the Catawba River (NC/SC). The study involved impounded and main-stem reaches with various anthropogenic influences. The researchers found that the minimally affected locations and locations near the thermal discharges produced the lowest (best) scores. Areas affected by industrialization and hydroelectric facility tailraces produced the highest scores. Fish Health Assessment may, therefore, not be an effective assessment tool in areas where thermal discharges are the only known stressor. They may, however, be effective at detection of stress from toxicants or significant habitat deficiencies.

As part of a holistic approach to power plant evaluations, fish health assessments would provide more detail on a population or “fisheries resource” level. Its greatest potential value is as a part of an integrated stock or community assessment. Adams et al. (1992) correlated the HAI with other measures of fish health for fishes of the Pigeon River. The HAI demonstrated the same patterns of fish health seen in the population and community assessments. The correlation between fish health assessment factors and community/population measures in a Tennessee creek system were not as clear (Adams and Ryon 1994). Many of the health assessment factors measured are biochemical and can indicate short-term stressors but may not be apparent in measurements at the community level. In this way, health assessments may be more sensitive assessment tools than something like an IBI. Although applicable to natural systems, the more simplified health assessment index (HAI) is not meant to be a diagnostic tool but used as a first level assessment of the health of a fish population.

### **3.2.6 Diversity Indices**

Diversity indices are a standard data assessment tool that prorate taxa richness by the number of individuals or the biomass of each taxon. By using both a quantity measure (number of individuals, biomass) and a quality measure (number of taxa), the problem of biomass increase with increasing nutrient inputs can be somewhat overcome for an assessment of diversity. Total taxa richness is, therefore, weighted to reflect the numeric representation in the community. Diversity values of 3.0 and above generally reflect excellent diversity. Diversity values below 1.5 generally reflect poor community balance. Between 1.5 and 3.0, diversity is slightly to moderately impaired, depending upon site-specific conditions (Tetra Tech 1996). Diversity indices generally considered non-statistical assessment techniques.

Diversity indices are most often used as only a single metric or measurement in conjunction with other measures of community health in contemporary bioassessment. Shannon (or Shannon Weiner) Diversity indices are sometimes used as a metric in regional modifications of the IBI and benthic RBP. It is also an integral part of the Iwb and mIwb used by Ohio EPA. Some researchers contend that diversity indices are meaningless (Hurlbert 1984) and should not be used alone for ecological assessments.

Several related indices exist that may be encountered in regional adaptations of biocriteria, depending on the preferences of the research team. For a general synopsis and review of typical diversity indices, please see Tong 1983.

### 3.2.7 Other Metric-Based Approaches

#### 3.2.7.1 Algal Assessments

Algal assessments, particularly periphyton bioassessments, have gained importance in some areas as monitoring tools (Rosen 1995). Although periphyton has been used as an indicator of water quality for years, few attempts have been made to standardize the assessment techniques until recently. Similarity indices, pollution tolerance indices, and diversity indices have been the most widely, used data evaluation techniques for algal assessments. In 1993, the State of Kentucky published a diatom bioassessment index (DBI) which utilized the traditional algal assessment measures and scored them from 1 to 5 based upon deviation from reference conditions. Its use does not appear to be widely known outside of Kentucky. Periphyton assessment can be useful in bioassessments because periphyton growth is dependent upon both nutrient and toxicant levels, and sampling techniques are relatively simple. However, laboratory staff must be trained and proficient in microalgal identification and enumeration to properly use periphyton as an assessment tool. It is, therefore, not among the techniques widely used by resource agencies for surface water evaluations, and would have limited use for utility impact assessments without the appropriate expertise.

The newest U.S. EPA RBP protocols have proposed a standardized protocol for periphyton assessments and data interpretation (Table 3-16). Periphyton can either be collected from natural substrates or collected on artificial (standardized) plates. U.S. EPA is proposing 13 metrics that, together, would constitute a diatom index:

1. Diatom Metrics
  - (1) Total Number of Diatom Taxa
  - (2) Shannon Diversity (for diatoms)
  - (3) Percent Community Similarity (for diatoms)
  - (4) Pollution Tolerance Index for Diatoms
  - (5) Percent Sensitive Diatoms
  - (6) Percent Mobile Diatoms
  - (7) Percent *Achanthes minutissima*
2. Non-Diatom Metrics
  - (8) Taxa Richness of Non-Diatoms
  - (9) Indicator Non-Diatom Taxa
  - (10) Relative Abundance of all Taxa
  - (11) Number of Divisions Represented by all Taxa
  - (12) Chlorophyll a
  - (13) Ash-Free Dry-Mass

The metrics would be scored in such a way that the sum High AI values (>200) would indicate dominance of heterotrophic organisms and community impairment. Extremely high values are indicative of poor water quality.

### **3.3 Hypothesis Testing Statistics**

The assessment of power plant impact frequently involves the comparison of quantitative measurements among groups of data. An example would be the comparison of fish abundance at near-field, far-field, and reference sites. It is widely recognized that these measurements are influenced by factors that are not always identifiable by the investigators and the variation that results from these unknown factors is attributed to chance. When making the comparison among groups, it is important to address the question "Is the observed difference larger than might have occurred by chance?" Mathematical statisticians have developed a large group of hypothesis testing procedures that are designed to address this question and are frequently useful whenever power plant impact assessment entails the comparison of groups.

These hypothesis testing methods can be broadly grouped into: 1) normal theory methods for continuous data (Section 3.3.2), 2) nonparametric methods for continuous data (Section 3.3.3), and 3) methods for discrete data (Section 3.3.4). The discussion for each of these groups begins with a review of the assumptions that are required for that group, for it is the assumptions about the distributional properties of the data that differentiate the three groups. Following the general requirements for each group, the discussion proceeds to specific test methods with their specific design requirements and an example of use in power plant assessment. Before reviewing each of these groups, certain fundamental experimental design requirements for all hypothesis testing methods are reviewed. In most cases it is difficult to meet these design requirements in field ecology studies. This results in a limitation of hypothesis testing methods that should be understood by all practitioners. While strict adherence to the protocol of experiments designed for hypothesis testing methods is difficult when assessing environmental impacts, hypothesis testing methods are widely applied, have been demonstrated to be robust even when some assumptions are not met, and provide useful information about the likelihood that an observed difference might have occurred by chance.

#### **3.3.1 General Discussion of Group Comparison Methods**

##### **3.3.1.1 Statistical Logic**

The inference that results from a statistical hypothesis test is based on an inversion of logic that should be understood by all practitioners. First one assumes that there is no difference between the populations being compared (e.g., the mean production at Site A



is equal to the mean production at Site B). This is called the null hypothesis. A statistic that measures the difference between the populations is computed. The statistical distribution of this statistic assuming the null hypothesis is true must be known. Using this distribution, the probability of observing a statistic as large as the observed difference is computed. This probability is called the p-value. If the p-value is small, it implies that it would be a rare event to observe a difference between the populations if the null hypotheses of no difference is true. Rather than conclude that a rare event has actually occurred, we conclude that the null hypothesis is false (e.g., the mean production at Site A is not equal to the mean production at Site B). Note that if a rare event has occurred, this inference about the null hypothesis is wrong. This is called a “type I error” or a “false positive error.” Under some circumstances, the likelihood of a false positive can be amplified, as discussed in a subsequent section. It is also possible to reach the wrong conclusion that Site A and Site B are not different when in fact they are. This second error is called a “type II error” or a “false negative error.” The relationship of the type I error to the type II error (“false negative error”) is discussed in the context of statistical power in Section 3.3.1.5.

### 3.3.1.2 Study Design Concepts

The standard protocol for running an experiment to generate data for hypothesis testing has the experimenter follow a simple procedure to ensure that the inferences from the hypothesis test are correct. The experimenter should gather experimental units that are uniform in the character to be measured. These experimental units should be randomly assigned to treatments. During the course of the experiment, any unknown factors that can affect the response must have equal probability of affecting any treatment. This last requirement might dictate that, for example, treatments be randomly arranged in a laboratory holding tray during an experiment. The experimenter following this protocol is in a strong position to infer that any difference among the treatments is due to the treatments.

It is clear that an ecologist working in the field does not have the luxury of following this protocol. It would require identifying uniform sampling areas, randomly assigning these to a reference site and a power station site, and then ensuring that any unknown factor has equal probability of affecting each site while populations in the sampling areas stabilize around the mean for the site. In fact, it is nearly impossible to implement any of the steps of the standard design protocol in field studies. How, then, does one justify the application of hypothesis testing techniques to field data?

The rationalization usually goes as follows. Sampling areas are chosen at random within the sites so that small scale spatial factors have equal probability of affecting reference and power station samples. The reference and power station sites are carefully chosen so that the two sites differ only by the influence of the power station. The reference site and the power station site are sufficiently proximate so that during the course of the experiment, any unknown factor that may affect one may also affect

the other. The pitfalls of this rationalization are obvious. Yet, hypothesis testing techniques are widely applied and thought to be useful in power station assessments and other environmental impact studies. For more discussion on the assumptions and approaches, see Wiens and Parker (1995).

### 3.3.1.3 Pseudo-Replication

One of the pitfalls of this rationalization has been identified and called “pseudo-replication” (Hurlbert 1984, Wiens and Parker 1995). Pseudo-replication occurs when some unknown factor differentially affects the treatments but uniformly affects the units within the treatments. It is easy to see how such a factor might be missed when choosing the reference site. If one conducts a statistical test that compares the difference between sites to the variation within sites, it is likely that the difference between sites will appear relatively large as a result of the differential effect of the unknown factor. This will lead to the false conclusion that the power station has an effect. Note that if the experiment were designed so that this unknown random factor could have differentially affected the units within treatments, then the difference between sites would have seemed relatively consistent with the variation within sites. This would result in the correct inference. The replicates or units within treatment are called “pseudo” because they fail to measure all of the random factors that are operative in the experiment. For example, plankton surveys are sometimes conducted using plankton nets that are towed side by side (bongo nets). Because of their proximity when being towed, both nets pass through the same patches of plankton. The difference between the observations obtained for a pair of nets is typically small. On the other hand, the patches of plankton sampled at an impact site will necessarily differ from the patches sampled at a control site. The difference between sites might be completely random and depend only on the unpredictable nature of plankton patchiness. A statistical test that compares sites is likely to lead to the false conclusion that the sites differ because the observed difference between sites is large relative to the observed variation within sites. This false conclusion results because observations from the paired nets do not measure the true variation due to plankton patchiness. The observations from the paired nets are thus termed pseudo-replicates. Patchiness could differentially affect the observations from the two sites but could not differentially affect the paired nets. Before accepting the conclusion from a hypothesis test, it is important to ask, “Does any random factor that can differentially affect the treatments have the opportunity to differentially affect the replicates within the treatments?” If not, then the experiment employs pseudo-replicates and is more likely to lead to false positive conclusions.

### 3.3.1.4 Multiple Comparisons

Another scenario that may lead to false positive conclusions occurs when an investigator conducts a number of statistical tests that relate to one hypothesis. For example, this might occur during the comparison of fish abundance between a power

station site and a reference site. The investigator may individually test 10 species with the idea that if the p-value for any species is less than 0.05, it is concluded that the sites differ. Note that 0.05 is the probability of making a false positive conclusion for any one species. The complement, 0.95, is the probability of not reaching a false positive conclusion which seems like quite acceptable odds. However, the probability of not reaching a false positive conclusion on any one of the 10 species is  $0.95^{10} = 0.60$ . Again, taking the complement, we find that the probability of making at least one false positive conclusion is 0.40 which seems unacceptably high. There are numerous procedures for obtaining an acceptable false positive rate when conducting multiple comparisons (Westfall and Young 1993).

#### 3.3.1.5 Statistical Power

Note that the logic paradigm discussed above (Section 3.3.1.1) leads to a rejection of the null hypothesis when the p-value is small but does not lead to acceptance of the null hypothesis when the p-value is large. This is because when sample sizes are small, it may be unlikely that a statistical test will produce a small p-value even when the true difference between the treatments is large. The probability that a statistical test will reject the null hypothesis by producing a small p-value is called the “power” of the test. Power is determined by many factors. Some statistical tests are more powerful than others. As a rule, more data leads to greater power, and the larger the difference between treatments, the more easily it is detected. Greater power is also obtained from lower variation among units within treatments. Power is also a function of the p-value cutoff for significance which is called the  $\alpha$ -level of the test. The more risk one takes of making a false positive conclusion (type I error), the less risk one has for a false negative conclusion (type II error) (Mapstone 1995). Low risk of type II error implies higher probability of correctly inferring a difference—which is the same as higher power. The important point is that one must demonstrate that a test has sufficient power to detect important differences between the treatments before it can be used as evidence that no important differences exist. For an overview of issues relating to statistical power see Toft and Shea (1983) with more discussion by Rotenberry and Wiens (1985).

#### 3.3.1.6 Statistical Significance vs. Biological Significance

It is a common misconception to assume that any difference that is statistically significant is also biologically important (Wiens and Parker 1995). This can be true if a study has been carefully designed to have sufficient power to detect important differences but not enough power to detect differences that are biologically unimportant. On the other hand, it can happen that a study has a sample size so large that it produces more than adequate power. For example, a fisheries biologist may obtain so many specimens that he or she is able to demonstrate that a mean length of 3-year-old fish at the power station of 29 cm is statistically different from a mean length of 30 cm for same-age fish at the reference site. Does this 1 cm difference appreciably

change the ability of these fish to overwinter from year 3 to year 4? Will it affect the value of these fish in the eyes of fishers? Any demonstration of statistical significance must be followed by an assessment of the biological importance when assessing power station effects.

The issues discussed heretofore under hypothesis testing are issues that must be considered generally when hypothesis testing methods are applied. Methods that have more specific requirements are discussed below.

### **3.3.2 Normal Theory Methods (Parametric Methods)**

The most widely applied methods in statistics are those that assume that the random component of a quantitative observation is distributed according to the normal or the Gaussian distribution. These methods are often collectively called parametric methods, but the term Normal Theory Methods is used here because mathematical statisticians are developing more and more methods that are parametric and assume some distribution other than the normal. This section deals only with the normal theory methods that are designed for comparison of groups. Other normal theory methods such as those designed to detect trends are dealt with elsewhere. The normal theory hypothesis testing methods discussed here are only a subset of a very large family of procedures that are collectively called General Linear Models (Rao 1973) and discussions of these methods can be found in most elementary statistics books.

#### **3.3.2.1 Data Requirement**

The primary requirement of all normal theory methods is replicated observations within the groups to be compared. The statistics generated by these methods (usually t-statistics or F-statistics) have in common the fundamental concept of comparing the differences among groups to the variation within groups. If differences between groups are large compared to the variation within the groups, it leads to the conclusion that the differences between groups are unlikely to occur by chance. That is, the null hypothesis of equality of groups is rejected.

#### **3.3.2.2 Assumptions**

Normal theory tests are based on the premise that data are composed of two parts: a deterministic part that is the result of known factors, and a stochastic part that is the result of random or unknown factors. We usually think of the stochastic part as deviations from the deterministic part. It is assumed that the random parts of the observations are stochastically independent and distributed as if they came from a normal distribution with mean zero and uniform variance, often briefly stated by the short hand "i.i.d  $N(0,s)$ ." In evaluating this assumption, it is helpful to break it into parts:

1. Independence implies that no single unknown factor affects two observations.

Independence can be difficult to assess. If observations have some underlying order such as collection sequentially through time or space, then one may test for autocorrelation using the Durbin-Watson statistic (Draper and Smith 1981) or a nonparametric runs test. Otherwise the investigator should use their knowledge of the system to assess whether unknown factors might affect multiple observations. If in a reference site it is observed that all observations within a subregion of the site are greater than the estimated mean for that site, it would suggest that some unknown local-spatial phenomenon (a local food supply) has affected all of these observations creating a statistical dependence.

2. A mean of zero for the stochastic part implies that the model being used for the deterministic part is capable of predicting the true mean without bias. More simply, it is assumed that the model is correct.

To assess the correctness of the model, estimates of the stochastic part of each observation are computed as the difference between the observation and the prediction for that observation based upon the model. These estimates of the stochastic part are called residuals. The correctness of the model is assessed by examining the residuals for clusters that are associated with some known factor that is not in the model. For example, if on examining the residuals from a t-test to compare a power station site to a reference site, it is discovered that all observations taken in January have negative residuals while observations taken in May have positive residuals, then it is clear that season must be added to the model for these clusters of observations to have mean zero. Note that if the investigator had not known that season was the cause of these clusters of similar residuals, then this result would be viewed as a violation of independence. That is, an unknown factor (season) was affecting more than one observation. Thus, omitting the season from the model yields an invalid analysis whether or not the investigator can identify the cause of the clustered residuals.

3. Uniform variance implies that the probability that a stochastic deviation exceeds a fixed value is equal for all observations. That is, on average, the stochastic deviations are uniform in magnitude. This assumption is important to most normal theory methods because the methods combine information from all groups in the analysis to estimate the effect of random error. If random variation around the mean at a control site is greater than the random variation around the mean at an impact site, it would be a violation of this assumption. For biological measurements such as abundance, random deviations tend to be proportional to the mean. This phenomenon leads to a violation of the equal variances assumption when means differ among groups. As discussed below and in Section 3.4.2.5, data transformations are sometimes useful for rectifying unequal variance problems.

Numerous statistical procedures are available to verify this assumption including the F-test for equal variances (Walpole and Myers 1972), Cochran's test (Walpole and Myers 1972), Hartley's F-max test (Milliken and Johnson 1984), Bartlett's test (Milliken and Johnson 1984), and Levene's test (Milliken and Johnson 1984). In addition, the validity of this assumption may be assessed by graphically displaying the dispersion of the residuals in the groups being compared using scatter plots or box-and-whisker plots (Cleveland 1993). The F-test is only useful for comparing variance of two groups. Bartlett's test is known to produce false positive results if the data are not normal. In some cases, a failure of the equal variances assumption can be rectified using a data transformation. If the variance tends to be proportional to the mean, that is large variance is associated with large values of the response, then a logarithmic or fractional power transformation (square root or cube root) will often yield a response that satisfies the equal variances assumption (Clarke and Green 1988). Percentage data frequently have the property of large variance when the response is near 50 percent and small variance as the response approaches 0 or 100 percent. This pattern of unequal variance is improved by the Arcsine-square root transformation (Govindarajulu 1988).

4. Normality implies that the distribution of the random components follow a distribution defined by a specific "bell shaped curve" that is completely defined by a mathematical expression once the mean and variance are known.

The normality assumption also gets considerable attention even though it is widely agreed that normal theory methods perform well (i.e., they are robust) even when the data are not normal. This assumption can be assessed graphically with a normal-probability plot (Cleveland 1993) and statistical procedures that test for normality such as the Shapiro-Wilks test or the Kolmogorov-Smirnov test (Gilbert 1987) may be applied. The application of these statistical procedures to residuals is not strictly legitimate. Like most statistical procedures, these tests assume that the data are independent. Residuals that are obtained by subtracting a group mean from the individual observations are not independent. To understand the nature of this dependence, omit one observation and recompute the residuals. Omitting an observation will change the group mean and thus change all of the remaining residuals. Clearly all residuals were dependent on that one. Therefore, the Shapiro-Wilks test and the Kolmogorov-Smirnov test should be viewed as benchmarks indicating normality rather than strict hypothesis testing procedures when applied to residuals. Lilliefors's test was designed to surmount this problem for normal and lognormal data (Gilbert 1987).

Like the equal variances assumption, a failure of the normality assumption can often be rectified with an appropriate transformation. If data have a frequency histogram that is skewed to the right (i.e., contains a few large numbers), then a logarithm or fractional power transformation will produce data that are more symmetric in distribution and thus more like the normal distribution. Data that have higher

frequencies in the tails of the distribution than is expected for the normal distribution can be made to appear more normal by an inverse tangent transformation. Data that are defined as proportions can be made to appear more like the normal distribution using the arcsine, logit or probit transformations. Often a transformation that helps resolve a problem with unequal variances also rearranges the data toward a normal distribution. When applying transformations to data, one must be aware that transformations rescale the data. Sometimes effects that are apparent in the original data, such as interaction effects in a factorial analysis of variance (ANOVA) model, will not be apparent in the transformed data (Sampson and Guttorp 1991).

Of these assumptions, it is important for the first three to be satisfied if the inferences based on the hypothesis test are to be correct. Tests have shown that the specific shape of the distribution of the stochastic deviations (assumption # 4) can be very different from that specified by the mathematical formula for the normal distribution and the results of the hypothesis test are reliable. This is especially true if sample sizes are large.

Any program employing normal theory methods should endeavor to demonstrate that these assumptions are satisfied. It is important to remember that these assumptions pertain only to the random part of the data. For example, when using a t-test, it is the deviations about the mean in each group that must satisfy the assumptions. To examine normality, one should compute estimates of these deviations by subtracting the mean of each group from each observation. These residuals are then pooled over groups and subjected to a test of normality. The normality of the raw data is not tested. If the groups have different means, then the raw data will have a bimodal distribution and will certainly fail the normality test even if the conditions required for applying the t-test are satisfied. Graphical methods often provide useful insights on the degree to which these assumptions are satisfied, though proper interpretation of graphics requires experience and is subjective. In some cases formal hypothesis tests are available for confirming each assumption.

### 3.3.2.3 Specific Normal Theory Tests

Several normal theory statistical tests are discussed below, and are summarized in Tables 3-17 through 3-25.

#### **Pooled T-Test**

The pooled t-test (Zar 1984, Walpole et al. 1998) is the simplest of normal theory methods (Table 3-17). It is designed for comparing two groups with independent replication in each group. The comparison of the abundance of a single fish species between a power station site and a reference site might be analyzed by a t-test. It should be noted that an unequal variances version of this test is available for use when

the uniform variances assumption is not satisfied. The use of this test for 'biological effects studies' is discussed in a conceptual way by Clarke and Green (1988).

### **Paired T-Test**

The paired t-test (Zar 1984, Walpole et al. 1998) is also for comparing two groups, but the design is more complex in that observations are paired by some factor. For example intake and discharge larval survival samples might be timed according to transit time through a power station so that the samples are paired in the sense that they are taken from the same water. The paired t-test can also be applied to simple repeated-measures studies such as toxicity of a discharge before and after de-chlorination. Method characteristics are summarized in Table 3-18.

### **Analysis of Variance (ANOVA)**

Analysis of Variance (Walpole et al. 1998) is an extension of the t-test to the comparison of more than two groups (Table 3-19). It tests the null hypothesis that all group means are equal. If this hypothesis is rejected, it does not elucidate how the means differ. Therefore it is usually used in conjunction with a multiple comparison procedure to determine which of the means differ. There is a plethora of multiple comparison procedures in the literature indicating that the statistics community has not reached a consensus on which method performs best. The Duncan's test, Student Neuman Keuls test, and Tukey's test are commonly used.

### **Randomized Block Analysis**

The randomized block analysis is an extension of the paired t-test to the design where more than two groups are paired or blocked (Walpole et al. 1998). A design to which this analysis might be applied is the sampling of an upstream reference, downstream reference, and a power station site all on the same day for several seasons. The three locations would be blocked by season for the analysis. Method characteristics are summarized in Table 3-20. Any factor that causes variance in environmental data, such as temperature, salinity, or water depth, which is not a variable of interest to the investigator, can be treated as a blocking variable in the design and analysis of an experiment.

### **Factorial ANOVA**

Factorial Analysis of Variance (Walpole et al. 1998) (Table 3-21) is an extension of the one-way ANOVA to a design that employs two grouping factors that are applied with a cross classified structure (every level of one factor appears in combination with every level of the other factor). A before-after/control-impact (BACI) design might produce data suitable for factorial ANOVA if the before and after units are chosen within the control and impact sites in a manner that ensures they are independent. One of the



great advantages of factorial ANOVA is the ability to test for interaction effects. An interaction in a factorial ANOVA implies that the effect size of one treatment depends on the level of another treatment. For example, with the BACI design, if there was no difference between control and impact in the before period, and clear difference between the two in the after period, this would be expressed in the analysis as an interaction of site and period. The concept of factorial ANOVA can be extended to more than two grouping factors which covers some very complex experimental designs. A complex example of factorial ANOVA in the assessment of fish larvae distributions relative to plumes of sewage outfalls is found in Gray et al. (1992).

### **Split Plot ANOVA**

Split Plot analysis (Milliken and Johnson 1984) is useful when experimental units within levels of one treatment are partitioned to allow application of another treatment. If zooplankton were being monitored for a power station assessment, one might sample at the surface and at the bottom of the water column at several locations within the reference site and the power station site. In this design the reference vs. station are the whole plot factors, locations within sites are the whole plot units, surface and bottom would be viewed as treatments applied to subplots of the whole plots. The whole plot part of the analysis is similar to ANOVA in that differences between sites would be compared to variance among whole plots units (averaging surface and bottom) within sites. The split plot part of the analysis is like randomized block analysis where the whole plots form the blocks, and surface and bottom are treatments applied within the blocks. Note that the whole plot design and the split plot design can be much more complicated than shown in this example. Method characteristics are summarized in Table 3-22.

### **Repeated Measures ANOVA**

Repeated Measures analysis (Milliken and Johnson 1984) is similar to split plot analysis in that the analysis has two levels (Table 3-23). On one level, treatment differences are compared to variation among units within treatments. On another level the same unit is measured repeatedly under different conditions. The BACI design mentioned above could be implemented as a repeated measures design. During the before period, several locations within each of the control and impact sites could be sampled. If during the after period, these same locations within sites are sampled for comparison to the before period, then the design is a repeated measures design and the data should be analyzed using a repeated measures model. As with the split plot design, both the within unit and the between unit parts of this design could be very complicated. The application of repeated measures analysis to environmental impact and monitoring studies is discussed by Green (1993).

### **Multivariate Analysis of Variance (MANOVA)**

Multivariate Analysis of Variance (Johnson and Wichern 1982) is an extension of ANOVA to experiments that measure more than one response variable within the same design (Table 3-24). For example, in an impact vs. reference site design, the abundance of three species might be monitored by the same collecting gear. MANOVA could be used to analyze these data. Each response in the data set would be a vector of length three. The null hypothesis is that none of the three species and no linear combination of the species differs between the two sites. If the null hypothesis is rejected, some follow up analysis in the univariate dimensions is required to understand which alternative to the null hypothesis is most likely. If the components of the vector are independent, MANOVA offers little advantage over doing separate ANOVA analyses with some adjustment for multiple testing. However, when the components of the vector are correlated, MANOVA can discover differences that might be missed by ANOVA. Consider the bivariate example in the following figure.

It is clear that if the data were projected onto the species 1 axis, the overlap of o's and x's would be considerable. The same is true for a projection onto the species 2 axis. Yet in the Cartesian plane, the x's and o's form distinct groups. For these data, a MANOVA statistic would be significant while the ANOVA statistics would not be. In addition to the usual normal theory assumptions stated above, MANOVA requires that the covariances be uniform among groups. The use of MANOVA for the analysis of benthic community data is discussed in Clarke and Green (1988).

### **Analysis of Covariance (ANCOVA)**

Analysis of Covariance is a combination of regression analysis (Section 3.4.2) and analysis of variance (Table 3-25). It is used in power station assessments in cases where there is a continuous nuisance variable for which one would like to adjust the data before comparing groups. For example, in an estuarine setting, one may wish to compare abundances at reference and power station sites, yet the abundance at both sites is strongly influenced by salinity. Using an ANCOVA model, one can adjust all observations at both sites to the estimated abundance for the mean level of salinity and compare the reference and power station sites on the basis of the adjusted data. In addition to the usual normal theory assumptions stated above, ANCOVA assumes that the relation of the response to the covariate is linear. ANCOVA might also assume that the slopes are parallel among treatments, depending on how the model is implemented and what hypotheses are being tested. Holland et al. (1987) present an example of using ANCOVA to assess seasonal and spatial trends in the benthic community in the vicinity of a nuclear power station. The covariates in the analysis were salinity and silt-clay content of the sediments.

### 3.3.3 Nonparametric Methods

#### 3.3.3.1 Concepts and Assumptions

Nonparametric statistical methods for comparing groups are methods that do not require a specific parametric distribution to describe the random part of the observed data. This freedom from specific distributional assumptions is usually obtained by computing a statistic based on rank order statistics. Thus, most nonparametric methods are invariant to monotonic transformations of the data (e.g., an analysis of the raw data or logarithms of the raw data would yield the same results). As a rule, if the assumptions of a parametric test are satisfied or can be satisfied by transforming the data, the parametric procedure will yield greater power than a nonparametric procedure for the same model. On the other hand, if data clearly do not meet the assumptions of parametric procedures, as would be indicated by the presence of outliers or a skewed distribution if one were considering a normal theory method, then the nonparametric procedure might yield greater power.

When originally introduced, nonparametric methods offered the advantage that computations were easier using integer ranks. With the availability of modern computers and software, this difference is moot. There remain some instances where it is easier to obtain ranks than quantitative data. For example, an investigator might be able to easily rank the degree of fouling on artificial substrates from the greatest to least while obtaining quantitative measures by scraping and weighing would be much more time consuming.

Whereas normal theory methods assume that the random component of each observation is i.i.d Normal(0,s), nonparametric methods relax the normality assumption and therefore apply to a wider range of distributions. Note that the assumptions of 1) independence, 2) identical distribution, and 3) mean (or median) of zero (correctness of model) still apply as described for normal theory methods. Thus, while some practitioners tout nonparametric methods as assumption free, this is incorrect. Nonparametric methods require these three assumptions and sometimes additional assumptions of continuity and symmetry for individual procedures.

#### 3.3.3.2 Individual Nonparametric Procedures

##### Wilcoxon Rank Sum Test

The Wilcoxon Rank Sum Test (Gibbons 1971) is a competitor of the pooled t-test in that the two tests apply to the same design. However, the null hypotheses of the two tests differ. The t-test assesses the equivalence of the means of two populations while the Wilcoxon rank sum test assesses the equivalence of the medians. The Wilcoxon test assumes that data are taken from a continuous distribution so that (theoretically) ties

are impossible (Table 3-26). However, if the number of ties is not great, applications to discrete distributions using midranks for ties seems to be satisfactory. Note that the Wilcoxon Rank Sum test is equivalent to the Mann-Whitney U test.

### **Fisher's Sign Test**

Fisher's sign test is a competitor of the paired t-test in that the data from the two groups being compared must be paired by another criterion (Gibbons 1971). The null hypothesis of the sign test differs from the paired t-test in that the sign test assesses the median difference while the t-test assesses the mean difference. To apply the sign test, the differences between the paired observations should form a distribution that is continuous in the vicinity of zero, so there is no chance that a difference is equal to zero. A summary of method characteristics is presented in Table 3-27.

### **Wilcoxon Signed Rank Test**

The Wilcoxon Signed Rank Test (Table 3-28) is also a competitor of the paired t-test (Gibbons 1971). An assumption important to the signed rank test is that the differences between the paired observations form a continuous distribution that is symmetric about its median. The distribution theory of this test is derived based on a null hypothesis that the median of the differences is zero. However, because the required assumption of symmetry implies that the mean is equal to the median, it may be considered a test for means or medians.

### **Kruskal-Wallis Test**

The Kruskal-Wallis test (Gibbons 1971) is an extension of the Wilcoxon Rank Sum test to a design with more than two groups and is therefore a competitor of the one-way ANOVA (Table 3-29). The null hypothesis of this test is that all of the data from the groups come from a single population with one median. The distribution for this population is assumed to be continuous, but midranks may be applied in case of ties. Karas et al. (1991) illustrate the use of the Kruskal-Wallis test in the analysis of Baltic perch dynamics in a pulp mill effluent area on the Swedish coast. In this study, the treatments were stations.

### **The Friedman Test**

The Friedman test (Gibbons 1971) may be applied to designs where treatments are replicated in blocks, and is thus a competitor of the Randomized Block Analysis. This test assumes that ties are impossible, which implies that the data come from a continuous distribution, but again, practice has shown that midranks can be applied to ties. This test is frequently applied where data are collected at several stations (treatments) on each of several dates (blocks) (Table 3-30).

## ANOVA of Ranks

Exact nonparametric procedures are not available for designs more complicated than a two-way layout which is addressed by Friedman's test. However, one author (Conover 1980) suggests that if an examination of residuals from ANOVA shows that the random part of the data are not normally distributed, then ANOVA on the ranks of the raw data is an approximate nonparametric procedure that can yield satisfactory results (Table 3-31).

## Randomization Tests

An area of recent advancement that is gaining increasing acceptance is methods based on computer intensive permuting of the data (Noreen 1989). These methods (Table 3-32) can be applied to almost any design that will allow reshuffling of the experimental units among groups. The basic tenet is that if there is no difference among the groups, then the null hypothesis distribution of the statistic being used to compare the groups can be approximated by reshuffling the experimental units among groups and recomputing the statistic. This reshuffling is done a large number of times (>500) until it is possible to approximate the null hypothesis distribution of the statistic. The observed statistic is then compared to this approximate distribution to obtain a p-value. If, for example, in 1,000 reshufflings, only 20 of the recomputed statistics exceed the original observed statistic, then this would correspond to a p-value of  $(2 \times 20)/1000 = 0.04$  for a two-tailed test. The null hypothesis for this test is simply that the populations are not related to the grouping.

## Tests Based on Bootstrapping

Another computer intensive method for comparing groups is based on "bootstrapping" (Noreen 1989; Efron 1982). Bootstrapping is a technique based on approximating the distribution of the test statistic by resampling the observed data. For statistical problems where optimal solutions are available, bootstrap methods have been shown to be very good approximations for the optimal solution. Bootstrapping has the tremendous advantage of being capable of approximating the distribution of statistics whose distribution is not obtainable through standard analytical methods. The method is summarized in Table 3-33.

### **3.3.4 Tests for Frequencies and Proportions**

The methods for comparing groups presented thus far are focused primarily on quantitative measures that are continuous or nearly so. Many studies, however, produce data that are clearly discrete. Examples include: counts of live and dead organisms in survival studies, frequencies based on length intervals in length-frequency studies, and presence or absence of species whose abundance is not large enough to be analyzed by continuous data methods. The statistical properties of discrete data differ

from those of continuous data and numerous analytical methods to accommodate the unique properties of discrete data are available (McCullagh and Nelder 1989, Bishop et al. 1975, and Fleiss 1981).

### 3.3.4.1 General Concepts and Assumptions

In general these discrete data methods assume that the distribution of the data is well approximated by one of the discrete distributions such as the binomial, the multinomial, or the Poisson. The data within each group must meet the independence and identical-distribution assumptions (as discussed for normal theory methods) for whichever distribution is assumed. Frequently, the p-values for these methods are obtained from a density function which approximates the distribution of the test statistic when sample sizes are large. This is called the asymptotic distribution of the test statistic (Cox and Hinkley 1974). Methods that rely on asymptotic distributions have sample size requirements.

### 3.3.4.2 Examples of Tests for Discrete Data

#### **Tests for Proportions**

Test for proportions (Table 3-34) are typically based on using the normal distribution to approximate the binomial distribution (Fleiss 1981). For small sample sizes, Yate's continuity correction is frequently applied. However, this has been shown to yield a conservative test (rejects the null hypothesis less often than it should). In power station studies, test for proportions might be applied whenever binomial random variables must be compared between groups. For example, to determine the effect of entrainment on larval survival, one might compare survival of larvae at the intake to survival of larvae from the discharge.

#### **Fisher's Exact Test**

Fisher's exact test (Fleiss 1981) is designed to test the hypothesis of equality in a two by two table. Note that the comparison of proportions in two groups can be expressed as a comparison of relative frequencies in a two by two table. Fisher's exact test (Table 3-35) produces exact p-values based on the hypergeometric distribution which is derived from the marginal frequencies of a two by two table. However, simulation studies have shown that this test yields conservative results when applied to binomial data.

#### **Chi-Square for 2-Way Table**

A Chi-square analysis is also available for two by two tables and can be applied to 2-way tables with more than two grouping factors in each dimension (Table 3-36). This test is based on the idea that if the frequencies in the rows are independent of the

columns, then the frequencies in the 2-way table should be accurately predicted by the marginal frequencies. The distribution theory derives from using a Poisson distribution of approximately a multinomial and then further using a normal(0,1) distribution to approximate the Poisson. Despite these successive approximations, the Chi-square analysis (originally by Pearson 1900, cited in Fleiss 1981) has been proven very robust whenever the expected cell size for all cells is greater than 5.

In power station studies, this analysis might be applied in the comparison of age structure among fish populations. Assuming that fish grow at comparable rates in reference and power station sites, collections at the two sites can be categorized by length intervals. This creates a 2-way table of frequencies with reference site and power station site on one dimension, and length intervals on the other dimension. Using the chi-square analysis one could test the null hypothesis that the proportions of fish observed in each of the length categories is equal between locations.

### **Chi-Square for Multiway Table**

Chi-square analysis can also be applied to tables with more than two dimensions as for example live/dead by intake/discharge done for each month of the year. There are several methods for applying the chi-square analysis to these higher dimensional tables depending on design features and the null hypothesis to be tested (Table 3-37). If these methods are needed, it is recommended that one seek the advice of experts or carefully study appropriate references (Bishop et al. 1975).

### **Log-Linear Models**

Log-Linear Models (McCullagh and Nelder 1989) offer another analytical technique for analyzing multidimensional tables of frequencies. Like the multiway chi-square described above, the application of log-linear models is complex and professional assistance is recommended if these methods are to be applied. A synopsis of the method is given in Table 3-38.

## **3.4 Trends Analysis**

The effect of the power station may not be a single impact that changes a population from one level to another, but a series of effects that accumulate over time and cause a "trend" For example, repeatedly cropping 10 percent of a population by impingement would result in a decrease over time if this cropping were not compensated by some feature of the population dynamics of the species being cropped. In systems with low flushing, such as lakes, the accumulation of pollutants over time might be studied using trend tests at various levels (e.g., trends in the concentrations of the pollutants). Changing levels in pollutants might result in trends in population standing crop or in population parameters such as fecundity. Trend tests are also useful for establishing the efficacy of mitigation actions. Does a stocking program help to increase standing

stock of a commercially important species? The remainder of this chapter describes a variety of trend assessment procedures and the situations in which they should be applied.

### **3.4.1 Graphical and Nonparametric Techniques**

#### **3.4.1.1 Run-Sequence Plot**

The simplest of all trend assessment procedures is to simply plot the data with time on the abscissa and the response on the ordinate. This graphical display is called a run-sequence plot or a time-series plot. From this plot one can readily assess both the strength of the trend and the degree of variation in the data without resorting to any complex statistical formulae. This makes the run-sequence plot a valuable presentation tool for audiences who are not well versed in quantitative methods. Not only are trend and variance readily apparent, but more subtle features such as the shape of the trend (linear or curvilinear) and the stability of the variance can be assessed from the run-sequence plot. Thus the run-sequence plot is supportive of almost any other analysis that one might conduct on data collected over time. Therefore, it is recommended that the run-sequence plot always be prepared for data that are collected over time regardless of what other assessments might be applied to the data. While the run-sequence plot is elegant in its simplicity, one must be cautious about scaling when interpreting these plots. Scaling can be used to exaggerate or diminish the appearance of trends in data (Huff 1954).

#### **3.4.1.2 Smoothing**

A mathematical tool that is frequently used with run-sequence plots is smoothing. Smoothing is based on the idea that the mean level of the response is a smooth function (no sharp angles or skips) of time. If this is true, then one might reduce the noise in the data while retaining its information about the level of response at a certain time by replacing each datum with an average of that datum and its neighbors. So for example a 3-point moving average smooth would replace point 2 by the average of points 1, 2, and 3; replace point 3 by the average of 2, 3, and 4; and so on. A large variety of smoothing techniques are available including various forms of moving averages (Shumway 1988), LOESS regression (Cleveland 1993), and Spline fitting (see references in Draper and Smith 1981).

#### **3.4.1.3 Nonparametric Trend Test**

Nonparametric trend tests are useful for detecting trends in responses that are influenced by a minimum of outside forces, or when data for modeling these outside forces are not available. A collection of trend tests methods are based on the Mann-



Kendall test for trend (Gilbert 1987) which is a test that applies to a single set of measurements taken over time (Table 3-39). Modifications of this test that allow for ties in time and ties in the response are available. The Mann-Kendall test has been extended to test for long term trends in the presence of seasonal trends and the result is called the Seasonal Kendall test (Gilbert 1987) (Table 3-40). Van Belle and Hughes (1984, cited in Gilbert 1987) provided extensions of the Seasonal Kendall test that allow testing for homogeneity of trend among locations in the presence of seasonal variation (Gilbert 1987) (Table 3-41). Because these tests are based on ranks, they do not provide an estimate of the rate of change of the response with respect to time. However, Sen's slope estimator (Gilbert 1987) does provide a nonparametric estimator of the change in the response over time and is often used as a companion to the series of Kendall tests.

Computer-intensive methods such as randomization tests and the Montecarlo test are useful nonparametric techniques for testing hypotheses concerning the presence of trends. Peterman and Bradford (1987) illustrate the use of Montecarlo methods to assess trends in English sole (*Parophrys vetulus*) off the west coast of North America. In this example, Montecarlo methods allowed assessment of trends with a complex population model that included oceanographic effects, biological and life history effects, and natural and fishing mortality.

### **3.4.2 Regression Analysis**

#### **3.4.2.1 Simple Linear Regression**

Simple regression analysis (Draper and Smith 1981) is a least squares procedure for fitting a straight line model to data that exhibit a trend (Table 3-42). The slope and intercept are the parameters of the optimal fitting line. These parameters are determined by finding that line that has the smallest sum of the squared residuals. In the regression framework, tests of hypotheses can be computed for all parameters in the model. A residual is the difference between an observed data point and its respective estimated value. In a graphical display of the data and the fitted line, the residual is illustrated by the vertical difference between the observed point and the regression line. Like analysis of variance, regression is an estimation technique that is a member of the larger family of general linear models (Rao 1973) and therefore requires all of the normal theory assumptions (see Section 3.3).

The tools for verifying the normality assumption that were described for ANOVA can be applied with regression as well. However, the tools for examining the regression model goodness of fit, the equal variances assumption, and independence differ from those used for ANOVA. The assumption that the model is correct is assessed by plotting the predictions from the model (the straight line) against the observed data. If the observed data show a series of deviations to one side of the fitted line, this indicates lack of fit for this model and model enhancements are needed (see below).

In addition to plotting the observed data against the fitted line, it is also useful to plot the residuals as a run-sequence plot. This graphic is also useful for identifying lack of fit and also can help to identify cases where the equal variances assumption is not met. If the residuals exhibit a pattern of increasing in absolute value in one direction or the other through the run-sequence plot, it suggests that the equal variances assumption is not met. Levene's test for equal variances can be performed to confirm this by subjecting the absolute value of the residuals to the same regression analysis as was performed on the observed data.

Autocorrelation (Draper and Smith 1981) is a special case of dependence among observations that can occur with data collected over time. Dependence occurs when one random event affects more than one observation. For example, when observing phytoplankton populations, a factor that might add variation to the observations is rain events. If a rain event increases flow which dilutes the standing crop of phytoplankton and two observations are taken before the standing crop recovers from this dilution event, then these two observations are dependent or autocorrelated. Autocorrelation is a violation of the independence assumption of regression and special techniques (see Time Series below) must be applied. To identify autocorrelation, one should examine the run-sequence plot of residuals for a tendency of short sequences of residuals with the same sign. A lag plots of the residuals, i.e., a plot of the residual at time  $t$  versus the residual at time  $t-1$ , is also helpful for identifying autocorrelation. The Durbin-Watson test (Draper and Smith 1981) is a formal test for first order autocorrelation.

A frequently overlooked assumption of all regression methods is that the independent variables are measured without error. In the case of a trend test where time is the independent variable, this assumption is usually satisfied. In cases where independent variables are field measurements, the assumption of errorless measurement may not be satisfied. An example of using simple linear regression to test for trends in the abundance of benthic organisms in the vicinity of a nuclear generating station with once through cooling is found in Holland et al. (1987).

#### 3.4.2.2 Multiple Linear Regression

Multiple linear regression (Draper and Smith 1981) is an extension of simple linear regression that accommodates more than one predictor variable in the linear model that predicts a single response (Table 3-43). This is useful in a power station context when one is interested in assessing a trend but knows that another factor such as flow or salinity also affects the response. For example, it may be known that increased flow enhances the benthic invertebrate community in a stream that is also influenced by a power station. The benthic invertebrate population exhibits an increasing trend over time, but 3 of the 5 most recent years have been high flow years. Are the recent high flow years sufficient to explain the increase in the population, or is there some additional factor contributing to the trend. The usual practice for addressing this problem is to first fit a model with flow as the predictor variable, then fit a second

model with flow and time as predictor variables. If the second model yields significantly better statistical fit than the first, it is inferred that some factor other than flow is contributing to the trend in the data. Multiple linear regression requires all of the assumptions of simple linear regression.

In multiple linear regression, there is a property of the predictor variables called multicollinearity (Draper and Smith 1981) that must be addressed. Multi-collinearity occurs when there is association between the predictor variables. In the benthic invertebrate example given above, high values of flow occur with high values of time. This phenomenon makes it difficult to demonstrate statistically which of the two variables is most likely associated with the response. Returning to the benthic invertebrate example, suppose time is added to the model after flow and it is discovered that time does not improve the prediction. Then suppose the variables are reversed so that flow is added after time and it is shown that flow does not improve prediction. And yet individually both flow and time appear to be good predictors. This perplexing result is caused by the multicollinearity or the association of the two variables. The two are so closely associated that one can say that either is a good predictor of the response but one cannot show that one is better than the other.

#### 3.4.2.3 Polynomial Regression

If it is shown that a simple linear regression model (straight line) does not fit the data adequately and yet no other logical predictor variables are available to add to the model, some form of curvilinear regression model may be needed. One way to obtain a curvilinear model is to introduce a nonlinear transformation of either the dependent or the independent variables (see transformations below). A second method is to build a low order polynomial equation in terms of the independent variable. Polynomial regression (Table 3-44) is just a special case of multiple linear regression where the additional variables added to the prediction equation are exponential powers of the first.

The researcher must be cautious in using polynomial regression not to “overfit” the data. If one is fitting a curve to data composed of  $N$  points, then a polynomial of degree  $N-1$  will yield an exact fit to the data. Clearly in a case of exact fit, the curve is not only trying to mimic the underlying trend in the data but also trying to mimic the sampling error. The objective is to use a degree of polynomial that is adequate to mimic the trend in the data and no more. If overfitting occurs, the future predictions based on the model will be unreliable, any hypothesis testing based on the model will be unreliable because the sampling error will be underestimated, and any predictions outside the sampling domain of the independent variables will be unreliable.

Whereas polynomial regression does yield a mathematical function that is nonlinear in the independent variable, it should not be confused with a technique called nonlinear regression. Polynomial regression is in the class of linear models because the

coefficients that are being estimated by least squares (the intercept, the coefficient of  $x$ , the coefficient of  $x^2$ , etc.) appear as linear terms in the predictive equation. Nonlinear regression (not detailed herein) is a technique that is applied when the parameters appear as nonlinear terms in the predictive equation as in the equation  $y = a + x^b + z^m$ . In this model, the parameters  $b$  and  $g$  appear as exponents.

#### 3.4.2.4 Multivariate Regression

Multivariate regression and multiple linear regression are terms that are frequently confused. Multivariate regression refers to a regression model that has two or more dependent variables that are all a function of the same set of independent variables (Table 3-45). Multiple linear regression, as defined above, has only one dependent variable and two or more independent variables. The dependent variables of the multivariate regression model should be thought of as a vector valued response. In a power station assessment, the need for this model might arise when multiple observations on a single experimental unit are made simultaneously. For example, larval fish populations could be measured at surface and bottom for a long sequence of observations. To assess long term trends in the larval fish population, a multivariate regression model could be implemented. The surface and bottom measurements constitute a vector of dimension two that could be modeled as a function of time and any other variables that are known to affect these populations and have data available. The advantage of the multivariate approach over fitting two univariate models is that the multivariate model will properly adjust for any covariance that might exist between the components of the dependent vector.

#### 3.4.2.5 Transformations

Mathematical transformations of both dependent and independent variables can play an important role in all regression analyses. Transformations can be implemented to achieve either linearity of model or improved distributional properties of the residuals. Quite often, the transformation that achieves one goal helps the other as well.

In physical sciences, the choice of transformation to achieve linearity is often dictated by first principals of the process being modeled. Radioactive decay follows a negative exponential model and thus a logarithmic transform will yield a linear model. Choosing a transformation based on first principals is sometimes possible with biological data, but more often the first principals that control the process are not so well known and a different approach is needed. This second approach entails viewing the data plotted on the Cartesian plane and choosing a mathematical function that will have a shape similar to that displayed by the data. This requires the practitioner to have a broad knowledge of mathematical functions and their corresponding graphs. If no transformation will yield a linear model of the mathematical function that mimics the data, then nonlinear regression methods may need to be implemented.

A second goal of transformations is improving the distributional properties of the residuals so that the normality or the equal variances assumption are better satisfied. If data exhibit a trend of increasing variance with increasing response, a logarithm or  $n^{\text{th}}$ -root transformation of the dependent variable may be needed to achieve a homogeneous variance structure. Often the transformation that stabilizes the variance also yields a linear model. If the data appear to be following a linear model before transformation and yet a transformation is needed to stabilize the variance, then the transformation must be applied to the dependent variable and the predictive equation. This manipulation may take a linear model and convert it to an equation that requires nonlinear regression methods. An alternative is to use weighted least squares (Draper and Smith 1980) on the untransformed data to account for the heterogeneous variance.

### **3.4.3 Time Series Analysis**

As indicated in the above section on Simple Linear Regression (Section 3.4.2.1), data collected over time can sometimes be correlated. When this occurs, procedures such as regression are not appropriate because the independence assumption of regression would be violated. Time series analysis (Table 3-46) refers to a group of techniques that have evolved to deal with the lack of independence of observations collected at adjacent time points. It is easy to imagine how this serial, or autocorrelation, arises in nature. For example, in monitoring larval entrainment, the distribution of larvae may be affected by seasonal spawning patterns, and diel behavior patterns. If the investigator is aware of these phenomena, they should design a sampling program to collect data day and night with sufficient frequency to capture the seasonal pattern. When assessing these data, the investigator would employ a model that included the seasonal factor and the diel factor. However, other factors of which the investigator is not aware may also influence the behavior and hence the entrainment rate of the larvae. Suppose that a wind induced seiche periodically created events of high entrainment. The effects of such an event might last for several sampling periods creating correlation in the adjacent observations. That is, several observations in succession that all deviate to the high side of what would be predicted by the model. When data are affected by random events, the effects of which may persist for two or more observations, then time series methods are needed.

Most time series methods require that the data have a property called covariance-stationarity, (Shumway 1988) which means that all pairs of points that are equal distance apart in the time series must have the same correlation. To meet this requirement, points 3 and 5, 7 and 9, and 11 and 13 must all have the same correlation. This does not mean that each pair of these points is affected in the same way by the same kind of random event. It just means that if a random event can affect both members of a pair, it must have equal probability of affecting all pairs. To build on the example above, if the seiche events occur with uniform probability throughout the period of observation, this would induce covariance-stationarity. If the occurrence of

the seiche events are clustered in an interval of time less than the period of observation, then the observations taken during that period will be more likely to be associated. We would say that they have stronger autocorrelation. The requirement of covariance-stationarity usually mandates that data for which time series analysis is planned be collected at equally spaced time intervals.

Time series methods for detecting trends fall into the class of time-domain regression methods (as opposed to frequency domain spectral methods, which are used to evaluate cyclical structure in time series in the absence of trends [Shumway 1988]). The time domain methods are an extension of the regression methods discussed above that incorporate terms to model the autocorrelation in the data. These terms can take the form of autoregressive terms, moving average terms, or differencing terms. Taken altogether, this collection of terms creates the Auto-Regressive Integrated Moving Average (ARIMA) family of models (Shumway 1988). Methods to identify which of these terms are needed for modeling data were given by Box and Jenkins (1970, cited in Shumway 1988) and have become standard procedure. Because the ARIMA models may be composed of two types of terms, some nomenclature is needed to differentiate the two. The autoregressive and moving average terms use deviations from the model at one time period to predict the mean value at the next time period. Structural terms are used to model the influence of outside forces, such as season and diel behavior patterns in the example given above.

Edwards and Coull (1987) described an autoregressive trend analysis of estuarine invertebrate fauna in South Carolina. Their results show that a simple linear regression was inappropriate due to autocorrelation in the data. They implemented a simple ARIMA model to assess trends. Their work describes tests for detecting autocorrelation, and provides a discussion of sampling-design considerations for time series analysis.

One special class of time series model that is likely to be useful in power station assessment is the intervention analysis. Intervention analysis is based on the premise that a time series is affected by a one time event that moves the mean level of the time series from one level to another. Thus, if one has time series data collected before and after the construction of a power station, intervention analysis is a tool that could be used to assess the effect of the power station. Intervention analysis is implemented by adding a binary variable to the suite of predictor variables. The binary variable is assigned a value of 0 for all observations taken prior to the intervention and 1 for all observations taken after the intervention.

Box and Tiao (1975) introduced the concept of intervention analysis with an application that sought to demonstrate that a shift in Los Angeles photochemical smog was coincident with a combination of new traffic patterns and new regulations controlling gasoline consumption. The authors use an ARIMA structure for the stochastic terms of

the model and various forms of intervention for the deterministic part of the model. Estimation by maximum likelihood is discussed.

#### **3.4.4 Other Trend Methods**

While the above discussion focuses on trends over time, it is also feasible to test for trends in a spatial dimension. Many of the same methods can be applied and many of the same modeling and dependence issues must be considered. A thorough discussion of the available methods for the analysis of spatial data is found in Cressie (1993).

Trends may also be assessed without any explicit model of trend by using a control or reference site. The null hypothesis is simply that the trend at the site being assessed is the same as the trend at the reference site. The statistical methods for this trend assessment are covered in the hypothesis testing section (3.3).

### **3.5 Multivariate Analysis**

Multivariate statistics refers to a group of analytical techniques that apply when two or more response measurements are taken from each experimental unit. Examples of multivariate responses that might arise in power plant assessment include:

- Counts for multiple species from a single grab sample or trawl sample,
- Measurements on numerous chemical constituents in a single water sample,
- Assessment of larval density at several depths in the water column, and

Length, weight, and girth measurements taken on individual fish.

The several responses per unit define a point in a vector space. For example, the length and weight of an individual fish define a two dimensional vector and the observations in this two dimensional space can be plotted in the Cartesian (X vs Y) plane. Distance between any two points in the Cartesian plane can be determined using the Pythagorean theorem,  $a^2 + b^2 = c^2$ , as shown in Figure 3-2.

Working in a vector space introduces the possibility of examining features of the data that are not readily available from univariate analyses. In univariate analysis, data are represented on the line of real numbers. Univariate analyses focus on distance between clusters along the line and variance (average distance from a point) within clusters along the line. In the vector space, distance between clusters and variance within clusters are examined, as well as correlation among components of the vectors. Distance is measured in some multivariate sense such as Euclidean distance which is obtained by extending the Pythagorean theorem to vector spaces of dimension greater

than two. At the same time that these distance issues are being assessed, correlation structure can also be assessed. Knowing that high values of one variable tend to associate with high values of another variable would be evidence of positive correlation and may change one's perspective of how groups relate. It is this simultaneous assessment of correlation and distances that make multivariate methods powerful tools.

Note that from a statistics perspective, data become multivariate when there are more than one response variables or more than one random variable. Thus, multiple linear regression, which estimates a prediction equation with one dependent variable and several independent variables (Section 3.4.2.2), is considered univariate because, of the several variables in the equation, only the dependent variable is a random variable.

Multivariate statistical methods can be grouped into three categories. Classification methods are used to identify groups of units according to distance or similarity measures. Principal Component Analysis and Factor Analysis are concerned with identifying groups of variables that covary. Multivariate Analysis of Variance and Multivariate Regression methods are concerned with hypothesis testing in a vector space and are dealt with in previous sections.

### **3.5.1 Classification and Multivariate Proximity**

#### 3.5.1.1 Distance and Similarity Measures

Distance and similarity measures are at the heart of classifying items into groups. While it is difficult to visualize the geometry of distance in vector space of dimension higher than three, mathematics provides a number of algorithms for computing distance. As a general concept, similarity is just the converse of distance. That is, the smaller the distance between two points in a vector space the greater their similarity. Typically, distance measures are bounded below by zero and unbounded above, while similarity measures are most often bounded above and below. Percent similarity for example ranges from 0 to 100. Euclidean distance measures distance along a straight line in the higher dimensional space. Other distance measures may emphasize distance in steps parallel to the defining axes (L1 norm distance) or simply presence and absence of attributes. The number of choices for distance measures is infinite. Similarity measures are also quite diverse. There are eight methods of computing similarity based only on presence/absence and many others that emphasize population features such as percent composition (Boesch 1977).

If the attributes being used to assign items to groups are measured by variables with symmetric distributions, which have roughly the same scale, and have equal variances, then Euclidean distance works well. Chemical constituent data sometimes have these properties but biological count data seldom do. The Bray-Curtis similarity (or distance)



index (Boesch 1977) which emphasizes similarity of species composition is an index that is widely applied for classification of items based on species counts.

### 3.5.1.2 Clustering

Clustering (Table 3-47) is a procedure that assigns items to groups based on distance or similarity between items in a vector space (Johnson and Wichern 1982). In power station assessment, the items are most often stations or zones in the vicinity of the power station while the dimensions of the vector space are defined by counts or densities of different species or taxonomic groups. Items might also be defined by points in time with vector dimensions defined by a number of species.

If a cluster analysis of species composition shows that all impact stations cluster into one group while all reference stations cluster in another group, this result suggests that the impact and reference zones differ in species composition. However, before concluding that the power station has impacted the ecosystem, it is important to verify that species changes from one zone to the other are of a nature that would result from the influences of the power station. For example, if the species whose abundances differ are also species subject to high impingement rates, then the cluster analysis results support the inference that impact has occurred. On the other hand, if the species differences are concurrent with a change in bottom substrate, then the cluster analysis results support the inference that the reference zone was not properly chosen.

Because distance and similarity are inverse concepts, this discussion proceeds in terms of similarity with no loss of generality. There are two fundamental approaches to clustering. One is to start with all items in one group and start dividing the whole into groups based on maximum similarity. The other is to start with individual items and to start building groups based on similarity. The first is called a divisive algorithm and the second is called an agglomerative algorithm. The approach used is often a function of the number of items. Agglomerative algorithms are used when the number of items is small and divisive algorithms are used when the number of items is large. The results of either approach can be presented as a dendrogram (Pielou 1969). However, the dendrogram is better suited to a small number of items.

Another feature of clustering for which there are many choices is the linkage rule. Once the distance measure is chosen, it is clear how to measure distance between two items, but how does one measure distance between one item and a group that has already been clustered? Possibilities include: a) the distance from the item to the center of the group, b) the distance from the item to the nearest member of the group, c) the maximum distance from the item to a member of the group, or d) the average of the distances from the item to all members of the group. This list is by no means exhaustive.

Because of the decisions involved—choosing a distance/similarity measure, choosing a clustering algorithm, and choosing a linkage rule—the number of cluster analyses that can be produced for a single set of data will always exceed the number of items being clustered. This flexibility of analysis provides a ripe venue for that often quoted expression “you can prove anything with statistics.” Because there are few objective rules for identifying the best cluster result, the investigator using cluster analysis is advised to proceed with caution. Cluster analysis should be viewed as a preliminary step to help discover patterns in the data. As a follow up to cluster analysis, it is important to examine the raw data and identify the attributes that form the common factors of a set of items that are grouped by the analysis. In a power station assessment, one must then decide if it is likely that the power station might have affected these attributes and what is the importance of these attributes in the ecological community. It is not sufficient to produce a cluster analysis where all impact stations are in one group and control stations are in another group and infer that adverse impact has occurred.

For example, some species are attracted to the heated effluent of power stations during some seasons of the year. It would not be unusual to observe data that showed high abundance of the attracted species at the effluent-affected stations and low abundance at the reference stations while other species had nearly equal abundance at both locations. If a cluster analysis was performed using an index that measured the similarity of percent composition, then impact and reference stations would appear dissimilar because the high abundance of the attracted species at the effluent-affected stations would make the percentages of the remaining species appear low. A conclusion of adverse impact is clearly not justified because all species save one have near equal abundance between impact zone and reference zone, and that one species has enhanced abundance in the impact zone.

Cluster analysis has been applied to assess changes in benthic fauna in the vicinity of oil platforms in the North Sea (Gray et al. 1990). Using this multivariate technique, the authors were able to demonstrate that the influence of the oil platform perturbation changed the species composition of the benthic fauna for a radius of 2 to 3 km from the platform. This result showed that clustering had greater sensitivity as an impact diagnostic than previously applied methods for this site.

### 3.5.1.3 Graphical Methods

Parallel axis plots and star plots are two graphical tools for illustrating multivariate data. Parallel axis plots orient axes parallel to one another and therefore there is no limit to the number of variables that can be displayed on one graph. Star plots have axes that emanate as radii from a central point. Again many axes can appear in one figure. These two graphical techniques are illustrated for the following table of data.

	Species					
Station	1	2	3	4	5	6
1	10	2	9	1	12	3
2	15	3	10	3	11	0
3	4	5	4	6	5	6
4	1	12	0	9	2	13
5	0	9	1	15	3	10
6	2	8	2	11	1	11

In the parallel axis graph (Figure 3-3), the first axis is for station and the remaining six axes display species abundance. The dot on each species axis shows the abundance of that species. All species abundances for a single station and the station code are connected by a trace across the graph. Beginning on the left at station 1 on the first axis, the line can be followed first to the abundance of species 2 at station 1 on the second axis, then to the abundance of species 4 at station 1 on the third axis, and so on across the figure.

When the data in the table are displayed in the parallel axis graph, some patterns are immediately apparent. Stations 1 and 2 have low abundances of species 2, 4, and 6 and high abundances of species 1, 3, and 5. Stations 4, 5, and 6 have high abundances of species 1, 3, and 6 and low abundances of species 2, 4, and 5. Station 3 does not conform to either pattern and is unusual in that it has intermediate abundances of all species.

In the more traditional Cartesian plane graphs (with perpendicular axes) we usually seek to find positive or negative correlation. With some practice, the viewer can learn to interpret patterns of positive and negative correlation in the parallel axis graph. Positive correlation can be inferred for the abundances of species 2 and 4. The lines connecting the abundances make few crossovers which implies that high values connect to high values and low values connect to low values. Negative correlation can be inferred for the abundances of species 6 and 1. There is a strong pattern of crossovers between these two stations which shows that high values at one station associate with low values at the other. One limitation of the parallel axis format is that these correlations are easy to interpret only for those axes that are adjacent in the plot. Numerous plots are required to have all axes appear adjacent to all other axes. It should be noted that the position of the species axes in this figure have been arranged to enhance interpretation.

Star graphs are another graphical technique for multivariate data. In the star graph, multiple axes radiate from a midpoint. The length of the axes depicts the value of the variable. The data from the table are plotted with one star for each station (Figure 3-4).

Each star has six axes, one for each species. As with the parallel axis plot, it is easy to see that stations 1 and 2 have similar species abundance patterns as do stations 4, 5, and 6. Again Station 3 stands out as unusual in that it has intermediate abundance for all species.

A summary of multivariate graphical techniques is provided in Table 3-48.

### **3.5.2 Correlation and Linear Structure**

While cluster analysis is concerned with the similarity of items, correlation analysis is concerned with the similarity of variables. If, when looking across stations, one sees that high densities of species X always co-occur with high densities of species Y and that low densities also co-occur with these species, then the two species are said to have positive correlation. Conversely, if high densities of one species occur with low densities of the other, then the two are said to be negatively correlated. There are several mathematical measures of correlation. The Pearson product-moment correlation and the Spearman rank correlation are most often used. It is not always easy to understand the full nature of relations among variables in a high dimensional data set when working with just these simple correlation coefficients that assess correlation between each pair of variables.

#### **3.5.2.1 Principal Components Analysis**

Principal Component Analysis (PCA) is concerned with assessing the linear relations among a large set of variables (Johnson and Wichern 1982). The analysis identifies groups of variables that are related in the sense that the variables are pairwise correlated or some linear combination of the variables is correlated. It also can produce scores that are linear combinations of the group of variables that captures a lot of the information content of the group in just one composite variable. Thus PCA can be used for either data interpretation or data reduction (Table 3-49).

It is easy to understand the data reduction principal of PCA when it is illustrated in two dimensions in Figure 3-5. The points plotted in the figure represent abundances of two species. The species have a positive correlation which suggest that one factor gives information about both species. PCA can be thought of as a rotation and translation of the axes used to define the data. The x-axis is rotated until it passes through the body of the data in such a way that when each datum is projected onto the new axis,  $x'$ , the variance is maximized. The origin of  $x'$  is moved to the center of the data. Now  $y'$  is

constructed perpendicular to  $x'$  and has its origin congruent with that of  $x'$ . If one were to project the data onto  $x'$  and use the projected observations instead

of the original data, very little information would be lost. The scores along the  $x'$  axis closely represent in a single dimension the abundances of both species that originally were represented in two dimensions. This illustrates the use of PCA for data reduction.

Using PCA for data interpretation requires more creativity. When there are more than two dimensions in the data, the eigenvalue components that are computed as part of PCA will identify groups of variables that tend to covary. After identifying a group of variables, one must apply expert knowledge or additional data analysis to identify the underlying factor that creates the correlation among these variables. In studies of benthos, particle size is most often the underlying factor that creates correlation among species. In a power station setting, temperature sensitivity may create another principal axis in the data that is related to temperature or some other power station effect.

The success of a PCA analysis is measured in terms of the percent of the total variance that is explained by each individual factor. In the figure, the variance along the original X and Y axes is about equal for the two variables. In the transformed space, there is much more variance along the  $X'$  axis than along the  $Y'$  axis. The factor associated with  $X'$  explains a high percentage of the variance.

While interpreting PCA results, it is important to remember that the PCA analysis is based on either the covariance matrix or the correlation matrix. In either case, only linear association among the variables is being assessed. If nonlinear associations are an important feature of the data, other techniques are needed. An example of a nonlinear association would be species A reaching its highest abundance in association with mid-level abundance of species B and species A having low abundance with both low and high abundance of species B. Swaine and Greig-Smith (1980) use PCA to successfully illustrate the effects of different grazing management strategies while sorting out the effects of soil type and time.

### 3.5.2.2 Factor Analysis

Factor analysis (Johnson and Wichern 1982) is a generic term for a large collection of multivariate techniques of which PCA is a special case (Table 3-50). Like PCA, factor analysis is used for data reduction and interpretation, but the emphasis is on interpretation. While PCA performs a rotation of axes and requires that the new axes be orthogonal (perpendicular) in the new space, factor analysis relaxes this requirement for orthogonality which permits greater flexibility in computing the factor loadings which help to identify which variables group together. For example, factor analysis with varimax rotation computes the factor loadings with as much variance as possible. Having high variance among the factor loadings makes it easier to sort the high

loadings from the low loadings which facilitates the interpretation of the correlations among the variables.

### 3.5.2.3 Ordination

Classification of sites is often made difficult by gradients in the environmental variables that influence species composition. A graphical technique called ordination is helpful for identifying gradients (Pielou 1969). Ordination entails plotting the PCA scores or Factor scores in the Cartesian plane with each point identified by some feature of the data (Table 3-51). To explore this phenomenon with an example of sampling benthos, a simple classification problem results when some sites are clearly mud and others are primarily sand. This difference in substrate is usually reflected in the species composition and a cluster analysis will easily differentiate the two groups. If, on the other hand, the sites represent a gradient of substrate from mud to sand, classification will be difficult because there are no clear groups. However, in this case, there would typically be one group of species that are increasing in abundance with increasing particle size and another group of species that are decreasing in abundance with increasing particle size. Using either PCA or Factor Analysis, these two groups should load on a factor than can be identified as associated with particle size. As was conjectured in the example above, a second factor might associate with temperature sensitivity. If these two factors were plotted on the Cartesian plane using a character to identify each site, one could quickly identify where each station fell along the particle size gradient by its position on the factor 1 axis, and identify the temperature influence by its position on the factor 2 axis.

As indicated, ordination is frequently used to enhance the interpretation of PCA. Swaine and Greig-Smith (1980) illustrate soil and temporal gradients in the species composition of vegetation on grazing plots using ordination. There are many ways to compute the canonical variables for ordination. One method that is gaining in popularity is correspondence analysis (Ter Braak 1988).

### 3.5.2.4 Canonical Variate Analysis

Identifying what variables group onto a single factor in PCA or Factor Analysis can be a first step in exploring data. One might follow this analysis by trying to discover what factors influence that group of variables. For example, the seasonality, linear trend, and relation to freshwater input of the temperature sensitivity factor could be assessed by using the temperature factor score as a dependent variable in a general linear model that used season, flow, and time as independent variables. In this analysis, the factor score is called a Canonical Variable because it is a computed variable that combines information from several observed variables.

Canonical correlation analysis (Johnson and Wichern 1982) is a technique for assessing the association between two sets of data, each composed of several variables (Table 3-52). To compute canonical correlation, a canonical variate is computed from each set of data in a way that maximizes the correlation between the canonical variables. One set of data might be species abundances for several species. The second set of data might be environmental data such as temperature, salinity, flow, and substrate particle size. Canonical correlation finds the linear combination of the species that has maximum correlation with the optimal linear combination of the environmental data.

Dickson et al. (1992) used canonical correlation to demonstrate significant correlations between ambient toxicity responses and changes in instream biological structure to demonstrate that ambient toxicity data are a valid predictor of instream impact.

#### 3.5.2.5 Discriminant Analysis

Discriminant Analysis is a technique that couples classification with computing canonical variables (Johnson and Wichern 1982). It is assumed that a training data set is available for which the groups are already known. Discriminant analysis is applied with one of two goals. One goal would be to devise a rule for classifying new observations as belonging to one of the groups. A second goal would be to discover what variables are useful for differentiating the groups. Using a set of variables observed with each observation, discriminant analysis finds the linear combination of those variables that yields the best separation between groups. Best separation is determined as the greatest difference between groups when compared to the variation within groups.

In power station assessment, it is more likely that discriminant analysis would be applied to discover what variables are important for differentiating groups. An example would be to determine which species are useful for differentiating impact from reference sites. When applied for this purpose, discriminant analysis is usually implemented as a stepwise procedure. That is, select the single variable that best discriminates the groups, then select the next variable that adds the most discriminating power to the discriminant rule, and so on until none of the remaining variables make a significant addition to the discriminant rule as determined by a statistical probability criterion. When applying this stepwise procedure, it is important to know that a variable may be a good discriminator between the groups but may not be chosen by the stepwise procedure because it is redundant (highly correlated) with a variable that has already been chosen.

Larsen et al. (1986) used discriminant analysis to demonstrate that fish abundance data could differentiate eco-regions defined in terms of land use, soil type, and vegetation features. Discriminant analysis method characteristics are summarized in Table 3-53.

### 3.6 Fisheries Management Assessments

Fisheries Management Assessment methods were derived for evaluation and management of fish stocks for the purpose of enhancing the yield of sport fish. The representative applications described below serve to illustrate that certain fisheries management techniques might prove useful in power plant impact assessment. All of the methods are based on the size of fish (typically some index or ratio of length) but one (relative weight) includes both length and weight.

The techniques are focused on measuring the “balance” of fish populations. This concept, devised by Swingle (1950) (as described in Anderson and Neumann 1996), defines the state of a fish population that could sustain a harvest of the larger members, in proportion to the productivity of the water. The methods can provide insight into the ecological state of a population, outside of the fisheries management context. For example, the available prey/predator ratio described below was designed to measure optimum ratios that result in high quality fishing. However, it is clear that the relative abundance of predator and prey is also an ecologically important concept. Ratios that are outside of certain bounds may be evidence of a stressed population or community. Given the potential for power-plant operation to stress aquatic communities in the receiving water bodies, the use of fisheries management assessment methods that focus on population “balance” appears to be an appropriate approach to impact assessment.

There are potential advantages to the use of these methods in assessing power plant impacts. For example, a number of these methods are routinely used by state resource agencies in managing fisheries. These agencies are routinely consulted by state permitting agencies when reviewing power plant effects issues. The use of assessment techniques that these resource agencies (e.g., Fish and Game) are familiar with could help streamline the impact assessment and review process. Also, depending on the location of a given power plant, there may be existing data on, for example, proportional stock density or relative weight, that could be incorporated into the impact assessment and provide potential cost savings.

#### 3.6.1 Available Prey/Predator Ratio (AP/P)

The AP/P index, one of the “weight models” described by Anderson and Neumann (1996), was formulated by Jenkins and Morais (1978) to evaluate the balance of fish populations in reservoirs. The biomass of prey fish small enough to be eaten by a particular size of predator fish is plotted as a function of the cumulative biomass of predators on log-log scales. In typical applications, the largemouth bass has been the primary predator and other predators were equated to the bass (as “largemouth bass equivalents”). A minimum desirable AP/P ratio has been proposed as 1:1, but Noble (1981) indicated that this needed further evaluation. When the 1:1 ratio is included in the log-log plot (as a 45 degree line), any predator length group plotting above the line



(ratio > 1.0) is interpreted as having an excess of forage available, and any predator length group plotting below the line (ratio < 1.0) is said to have a deficiency of forage available (Figure 3-6). Anderson and Neumann (1996) reported successful use of the method for documenting shortages and surpluses of available prey, including on a seasonal basis, based on the work of Jenkins (1979) and Timmons et al. (1980). The AP/P ratio appears to be a useful tool for fish managers with responsibility for monitoring and managing fish populations to optimize sport fishing.

One drawback of the method is that it requires an unbiased estimate of the stock biomass of both prey and predator species. Such estimates can be difficult to produce because all fish sampling methods are size-biased to one extent or another. Because the AP/P ratio is based on size, accurate estimates of the abundance of all available sizes of prey and predator species is required. Typical applications of the method (e.g., Timmons et al. 1980) have used the fish toxicant rotenone to obtain relatively unbiased population samples.

### **Application**

Timmons et al. (1980) employed the AP/P ratio as part of their assessment of differential growth of largemouth bass in a Georgia reservoir. Since reservoir impoundment in 1975, young largemouth bass had consistently presented a bimodal length distribution. Based on AP/P ratios, periods with inadequate prey availability appeared to be related to the bimodal length distribution. That is, a shortage of prey at the time the bass were changing from insect to fish prey, resulted in a slower-growing group of young, and thus the bimodal length distribution.

The originators of the AP/P ratio, Jenkins and Morais (1978) used the technique to evaluate the status of prey availability in 23 southern reservoirs. Nine of the 23 reservoirs were determined to be deficient in prey in both 1972 and 1973. Such information is of value to fishery managers who can use it to set management approaches, stocking plans, and other measures to enhance the fishery.

The AP/P ratio has potential for use in assessing power plant impacts because it is a measure of population "balance," which is a relevant element in impact assessment. If appropriate data are available, the AP/P ratio could be used with other measures/models in a weight-of-evidence assessment approach. However, the requirement for unbiased samples of predator/prey stock sizes may limit applications to special cases, perhaps small cooling water lakes or rivers, where it may be possible to obtain reasonable estimates of stock sizes.

The basic characteristics of the Available Prey/Predator Ratio method are listed in Table 3-54. There is potential for application of the method in power plant impact assessment, although no such applications have been encountered in searches of peer-reviewed literature. There have been relatively few applications published, and those

were either directly or indirectly focused on management of largemouth bass. Broader application of the method would require research into what ratios were optimal or minimum for a given predator species. Conceivably, simple measurement of prey-predator ratios could be done, and compared between impacted and reference areas. This, however, would not be a strict application of the method as described, because results would not be compared to predator-specific optimum or minimum ratios. Perhaps the most advantageous application of the method in power plant impact assessment might be in situations where the data already exist for a receiving water body, e.g., in state resource agency files. Such data might be incorporated into the impact assessment or even augmented to strengthen the assessment of impact to fish populations.

### **3.6.2 Young/Adult Ratio (YAR)**

Another size-based index used by fisheries managers is the Young / Adult Ratio (Anderson and Neumann (1996). The YAR index, proposed by Reynolds and Babb (1978), can provide insight into reproductive success and population structure. The index is calculated by dividing the number of young in a sample or population by the number of adults. For example, for late season largemouth bass, the YAR may be calculated as the number of fish  $\leq 15$  cm divided by the number  $\geq 30$  cm (Anderson and Neumann 1996). The method characteristics are summarized in Table 3-55.

#### **Application**

Anderson and Weithman (1978) calculated YAR for five coolwater fish species including yellow perch and walleye. They recognized YAR as a convenient index for measuring the success of reproduction. The authors presented information indicating that a "favorable" ratio was 1 - 3:1, or between one and three young fish for every adult of "quality" size. They also identified a relationship between YAR and Proportional Stock Density (PSD) (see next section), and pointed out that YAR values less than 1:1 could indicate a weakness or failure of a year class.

As with other techniques discussed in this section, the YAR is a special case of length-frequency analysis. Because it assesses population "balance," it could have application in power plant impact assessment. The method is constrained by the requirement for samples unbiased by size of fish. Such data are not always available, or feasible to obtain. If data are available, the YAR would be a good adjunct to other models and indices in a "weight-of-evidence" approach. The method has not been widely tested in peer-reviewed applications, and applications to power-plant impact assessment are apparently few. EA (1987) used the YAR in conjunction with other methods to evaluate fish populations in a power-plant cooling reservoir in North Dakota. Because the basic fish length and count data required are routinely collected during any field impact assessment, it may be possible to employ this technique at a site with little additional investment of effort and cost.

### 3.6.3 Proportional Stock Density (PSD)

Length-frequency distribution data ( i.e., the proportion of fish in a sample or population in each of a number of size groups) has long been used in fisheries science to gain insight into the structure and condition of fish populations. Johnson and Anderson (1974) and Anderson (1975) employed length-frequency data to evaluate the state of balance of sport fish populations. The term “balance” is central to fishery management practice, and has not only social, but ecological implications. Using desirable growth and mortality rates, Johnson and Anderson (1974) calculated the proportions of largemouth bass and bluegill above certain lengths that should fall into specified length categories. The term Proportional Stock Density was first used by Anderson (1976) to reflect the percentage of “stock length” fish in a population that were equal to or longer than a specified length. For example, a PSD may be calculated as the number of fish equal to or longer than 12 inches, divided by the number equal to or longer than 8 inches. Anderson (1978) refined the PSD index by identifying a size category of “quality length”(rather than “specified length”). Testing and application of the PSD index on species other than largemouth bass and bluegill began with Novinger and Dillard (1978) and Anderson and Weithman (1978). Essentially, the PSD method is a simplified application of traditional length-frequency analyses, that is keyed to specific fisheries management objectives (e.g., “quality” length category). The characteristics of the PSD method are summarized in Table 3-56.

#### Application

PSD goals can be developed for fish stocks using available information on growth, mortality, and an assumed stock biomass or recruitment rate (Anderson 1976). Using such information, Anderson (1975) developed PSDs for largemouth bass in Wisconsin and Oklahoma of 45 and 65 percent, respectively. That is, the percent of fish  $\geq 8$  inches that was also  $\geq 12$  inches in Wisconsin was 45 percent. Based on Missouri pond populations, a PSD of 25 percent was calculated for bluegill (percent of fish  $\geq 3$  inches that was also  $\geq 6$  inches long). Once PSD goals are developed for a stock, that population can be periodically monitored and management measures taken if the PSD varies below or above the goal. Anderson (1976) provided an example of how PSDs can be used to monitor the balance of bass and bluegill stocks in a lake.

There is potential for application of the PSD index for evaluating power plant impacts, but this potential must be qualified, as with all field-derived data. As discussed by Kumar and Adams (1977), using fish monitoring data to evaluate power plant impacts is very difficult due to the nature of open aquatic systems, the mobility of fish, highly variable environmental conditions, and the problem of separating changes in fish stocks due to natural factors from those that may be related to power plant operation. Investigators have attempted to compare various measures of fish communities (e.g., growth, density, diversity) between intake/discharge “impact” areas and control areas,

and between pre-operational and operational periods. Such comparisons are easily and often confounded by the above factors.

By itself, the PSD index has limited usefulness in assessing power plant impacts because its focus is too narrow (e.g., the PSD ignores young fish). Its focus is on the monitoring and management of “catchable” size fish, and any fish less than the designated “stock length” are ignored in the calculation. In an overall sense, and particularly regarding the effects of entrainment and impingement, it is the smaller fish that are generally more vulnerable to power plant effects. However, stress experienced by the young of a population may be reflected in indices like PSD. If the PSD index were combined with a number of other measurements, it may be of some value in a “weight-of-evidence” approach.

EA (1987) employed the PSD index in combination with several other fishery management techniques to evaluate sport fish populations in a North Dakota cooling reservoir. The authors assumed a quality fishing goal for largemouth bass and bluegill, and calculated PSD for these species, plus black and white crappie. The PSD of 41 for the largemouth bass was on the low end of the recommended range (40-60), and that of 41 for the bluegill was in the upper end of the recommended range (20-40). In conjunction with other indices such as Relative Stock Density and Relative Weight, these results suggested an unbalanced community due to overharvest of largemouth bass, and overabundance of bluegill. The crappie PSDs were much higher than expected; this was attributed to a strong 1983 year class in conjunction with poor production of young in 1986 (year of study). It was concluded that community structure, as reflected in several fishery management indices, was reflective of typical midwestern impoundments, and showed no evidence of power-plant operational impacts.

#### **3.6.4 Relative Stock Density (RSD)**

The concept of Relative Stock Density grew out of that of Proportional Stock Density. Defined by Wege and Anderson (1978), the RSD was used by Anderson (1980) in identifying the percentage of stock-length largemouth bass  $\geq 15$  inches in a quality fishery. In contrast to the PSD where the percentage of stock-length fish equaling or exceeding a single specified length is calculated, the RSD allows calculation of more than one index depending on management objectives. Thus, rather than a PSD index based on the proportion of stock-size largemouth bass  $\geq 12$  inches, there may be an RSD-15, the proportion of stock-size fish  $\geq 15$  inches. The use of the term RSD connotes a recognition that there may be more than one length group of interest in the management of a fish population. Gabelhouse (1984) developed a length-categorization system consisting of five length groups: stock, quality, preferred, memorable, and trophy. For largemouth bass in Kansas, the minimum lengths of these groups were 8, 12, 15, 20, and 25 inches, respectively. Thus, for example, a length of 15 inches was the

lower limit of RSD-15 (or RSD-P [preferred]). With the exception of the additional length categories in the RSD, the basic method characteristics (Table 3-57) are similar to those of the PSD (Table 3-56).

### Application

Guy et al. (1996) used the RSD index to evaluate the relative merits of trap nets and gill nets for stock assessment of white crappie in Kansas reservoirs. The minimum total lengths for size categorization were: stock = 13 cm; quality = 20 cm; preferred = 25 cm; and memorable = 30cm. The RSD was then calculated as:  $100(\text{number} \geq \text{quality, preferred, or memorable}) / (\text{number} \geq \text{stock})$ . It was determined that RSD values by length category were significantly correlated between gears, suggesting that size structure indices covaried among samples for the two gears, thus supporting calculation of size structure indices using either gear. Proportional Stock Density (PSD) catch-per-unit-effort data were also evaluated by the authors.

The RSD indexes appear to provide more value and flexibility to fisheries managers than the PSD. However, the value of such indexes in evaluating power plant impacts differs little from that of the PSD. As with the PSD, the RSD is focused on larger fish, and ignores young fish that may be more vulnerable to power plant operations in some settings. To the extent that stress to young fish may be reflected in the proportions of larger length groups, the method may allow some insight into power plant effects, particularly when used in conjunction with other methods in a weight-of-evidence approach. EA (1987) utilized the RSD index along with the PSD index in their evaluation of a North Dakota cooling lake.

#### 3.6.5 Relative Weight (*Wr*)

Relative Weight (*Wr*) is a special form of condition factor, or “ponderal index,” that is used in the “assessment of the plumpness and physiological well-being of fishes” (Carlander 1969; Murphy et al. 1991) (Table 3-58). Murphy et al. (1991) described an evolution of condition indices, starting with the Fulton condition factor which, in its metric form, is described as

$$K = W/L^3 \quad (\text{eq. 3-2})$$

where *W* is weight in grams and *L* is length in millimeters.

The *Wr* index has been used by fisheries managers to compare samples of fish to determine relative health, or well-being. Because the *K*-value varies with length, comparisons were restricted to similar length-groups of the same species. Le Cren’s (1951) relative condition factor offered an improvement whereby fish of different lengths could be compared. This relative condition factor is calculated as

$$K_n = W/W' \times 100 \quad (\text{eq. 3-3})$$

where  $W$  is the observed weight and  $W'$  is the length-specific expected weight based on a weight-length regression equation for the population. The relative condition factor could be used to compare fish of different lengths, but the comparisons were restricted to the population for which the weight-length regression was calculated.

Wege and Anderson (1978) proposed a relative weight index ( $W_r$ ) that was said to allow comparison of not only different length fish, but fish from different populations or species. This was calculated as

$$W_r = W/W_s \times 100 \quad (\text{eq. 3-4})$$

where  $W_s$  is the length-specific standard weight predicted by a weight-length regression developed for the species as a whole. Thus, whereas earlier investigators employing the Fulton condition factor were restricted to comparing similar-length fish from the same population,  $W_r$  theoretically allows valid comparisons of weight among different size groups between and among populations of a species. This offered distinct advantages for fisheries managers, and the technique has become widely used. However, Marwitz and Hubert (1997) demonstrated length-related trends in  $W_r$  in walleye in Wyoming reservoirs apparently related to prey availability. Murphy et al. (1991) pointed out that the rapid proliferation of the technique has led to some confusion as regards the important underpinning parameter  $W_s$ . These authors reviewed existing  $W_s$  equations, and made recommendations for developing standardized equations.

An additional advantage of  $W_r$  is that it appears to reflect proximate body composition of individual fish (e.g., fat content, etc.) (Murphy et al. 1991). These authors cited several studies wherein strong correlations were measured between  $W_r$  and fat reserves. In contrast, Strange and Pelton (1987) found little relationship between the Fulton-type condition factor ( $K$ ) in fat percentages of forage fish. Consequently, Murphy et al. (1991) thought that  $W_r$  may be a useful indicator of short-term growth potential or possible resistance to nutritional stress.

The use of the  $W_r$  has not been without controversy. Cone (1989) published a critique of  $W_r$  and condition indices in general. He attacked the underlying assumptions of the method, and recommended ordinary least-squares regression as a much better way to compare weight-length relationships. Cone's paper engendered considerable critical response, as evidenced by four "comment" papers by six investigators published in *Transactions of the American Fisheries Society* (Springer et al. 1990). Cone's responses were also included in that publication. Although acknowledging several mistakes in his 1989 paper, Cone reiterated his criticism of the fundamental assumptions

the validity of the  $W_r$  index does not appear to have been satisfactorily resolved, it has gained wide acceptance among fishery managers and the method continues to be used (e.g., Rogers et al. 1996, Guy and Willis 1995). Murphy et al. (1991) reported regular use of the index by 19 states in 1985. This number has very likely increased.

### **Application**

The potential application of the  $W_r$  index is illustrated by the program funded by Commonwealth Edison to monitor a 53-mile reach of the Upper Illinois Waterway (UIW). Six of ComEd's generating stations are located in this reach, and the company has funded annual field studies for some years. Prior to 1993, fish condition was measured by the Fulton condition factor (K), but few spatial or temporal variations were observed (EA 1996b). Because of this, and the fact that most Illinois state agencies had adopted the Relative Weight Index as the most appropriate measure of fish condition, ComEd began employing it in its monitoring program on the UIW. Fish are collected from up to 42 locations in the UIW, and individually measured (mm) and weighed (gm). Mean  $W_r$  by size group was calculated for all species (EA 1996). When sufficient spatial and temporal data were available, the  $W_r$  results were subjected to ANOVA. Although results varied among species, there was a general trend of higher  $W_r$  at upstream locations for most species. Some species exhibited seasonal differences and some did not. It is anticipated that the monitoring program will continue, and that ultimately the  $W_r$  data along with other information may be used to document presence or absence of power plant impacts.

The relative weight index may have a more direct application in a special case such as fish overwintering in a power plant discharge canal. Some investigators have hypothesized that fish can be "trapped" in the warmer discharge waters for extended periods, and be subject to unnatural stresses. To investigate this possibility at a Connecticut power plant, Marcy (1976) used the Fulton-type condition factor (K) to compare catfish overwintering in the discharge canal with fish in a nearby reference area. He found condition of brown bullheads that overwintered in the discharge canal to be significantly lower than condition of bullheads from a reference area. Other investigators (e.g., Bennett 1972) have found fish condition to be enhanced in fish overwintering in power plant discharge canals. The relative weight index could conceivably be applicable in such investigations.

In addition to theoretical concerns regarding its applicability described above, application of the index for assessing power plant impacts is subject to most of the above-described limitations for the PSD and other indices. Discriminating power plant impacts from other biotic and abiotic factors in the environment can be problematic. If one is investigating either discharge or intake effects, there has to be a way to reasonably ensure that the "impacted" population has actually had significant contact with the discharge or intake. The mobility of fishes can confound this. As with other indices described earlier, and given reasonable discrimination of impacted and

“control” portions of the population or community, the  $W_r$  index may provide some added value in a weight-of-evidence approach that includes other impact assessment methods.

### **3.6.6 Other Fisheries Management Techniques**

There are other techniques traditionally used by fisheries biologists that could conceivably be used in the assessment of power plant impacts. Examples of these measurements or calculations include:

- Fish growth rates
- Fish population or stock size
- Catch per unit effort
- Fish movement
- Reproductive capacity (e.g., fecundity, gonadosomatic index)
- Sport or commercial harvest
- Diet (food habits)
- Community structure

These and other fisheries techniques are described in various compendia, e.g., U.S. EPA (1993), Gulland (1989), Gunderson (1993), Hilborn and Walters (1992), Murphy and Willis (1996), Ricker (1975), Ross (1996), Rothschild (1986), and Schreck and Moyle (1990). All of these parameters have been evaluated by fisheries managers to enhance their understanding of, and increase their ability to manage fish populations and communities for optimum sport or commercial yield. It is intuitive that any one of these aspects could be affected—either positively or negatively—by the operation of a power plant. Consequently, any one or a combination could conceivably be used as an impact assessment technique. For example, Marcy (1976) used a number of these techniques in a weight-of-evidence approach to impact assessment at the Connecticut Yankee Atomic Plant. He compared catch-per-effort statistics between pre-operational and operational periods. After the plant began operation, Marcy (1976) compared age and growth, fecundity, ovary weight, ova size, and sport harvest among upstream and downstream areas of the Connecticut River, and the plant discharge canal. EA (1979c) employed catch-per-effort data in upstream-downstream comparisons at a Pennsylvania power plant, and also measured age and growth, fecundity, movement, and food habits of key species to generally characterize the community in the vicinity of the plant. EA (1979c) studied movement of fishes via tag-recapture techniques to



confirm a “zone of passage” past the plant thermal discharge, pursuant to Section 316(a) regulations (U.S. EPA 1977).

Employment of any or all of these fisheries techniques in the assessment of power plant effects is subject to the same constraints described above. Because of the mobility of fish, an investigator must be able to ensure that what is being measured as “impacted” has actually been influenced by the plant, and what is said to be “control” has in fact not been influenced by plant operations. For example, the demonstration of a reduced growth rate of a fish species near a power plant relative to “far field” does not confirm a plant impact unless it can be established that the nearfield portion of the population has been in extended contact with the plant (intake or discharge or both) to the exclusion of other areas. This can be difficult to document. Consequently, fisheries management techniques may more effectively be employed in power plant impact assessment as multiple, overlapping techniques, as was done by Marcy (1976).

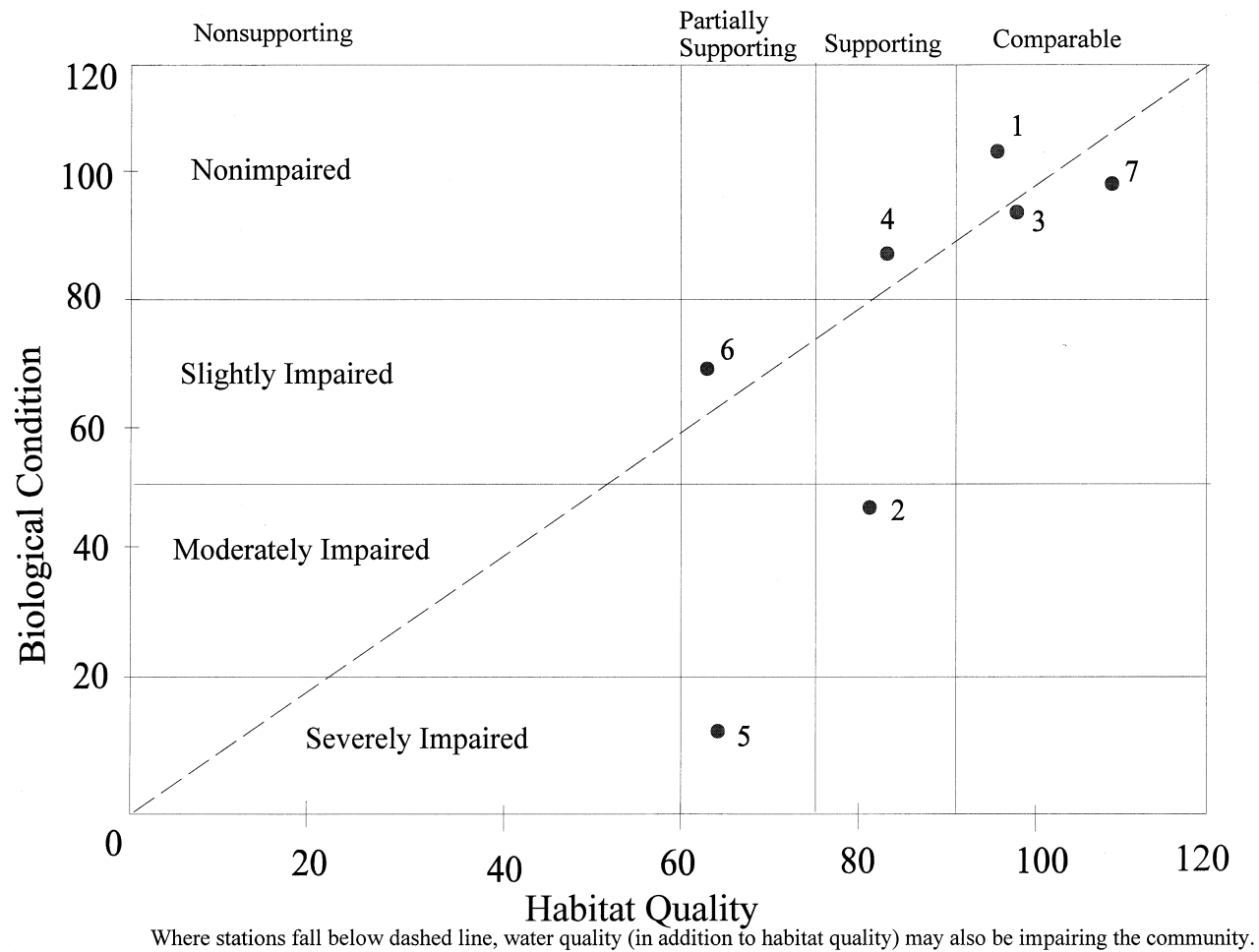

**Figure 3-1**  
Relationship between habitat quality and biological condition.

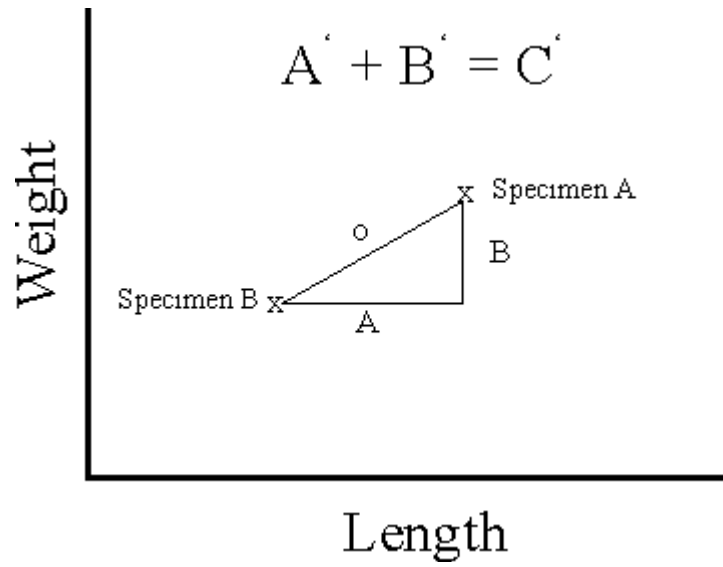

**Figure 3-2**  
The Pythagorean theorem provides a tool for measuring distance in two dimensional space.

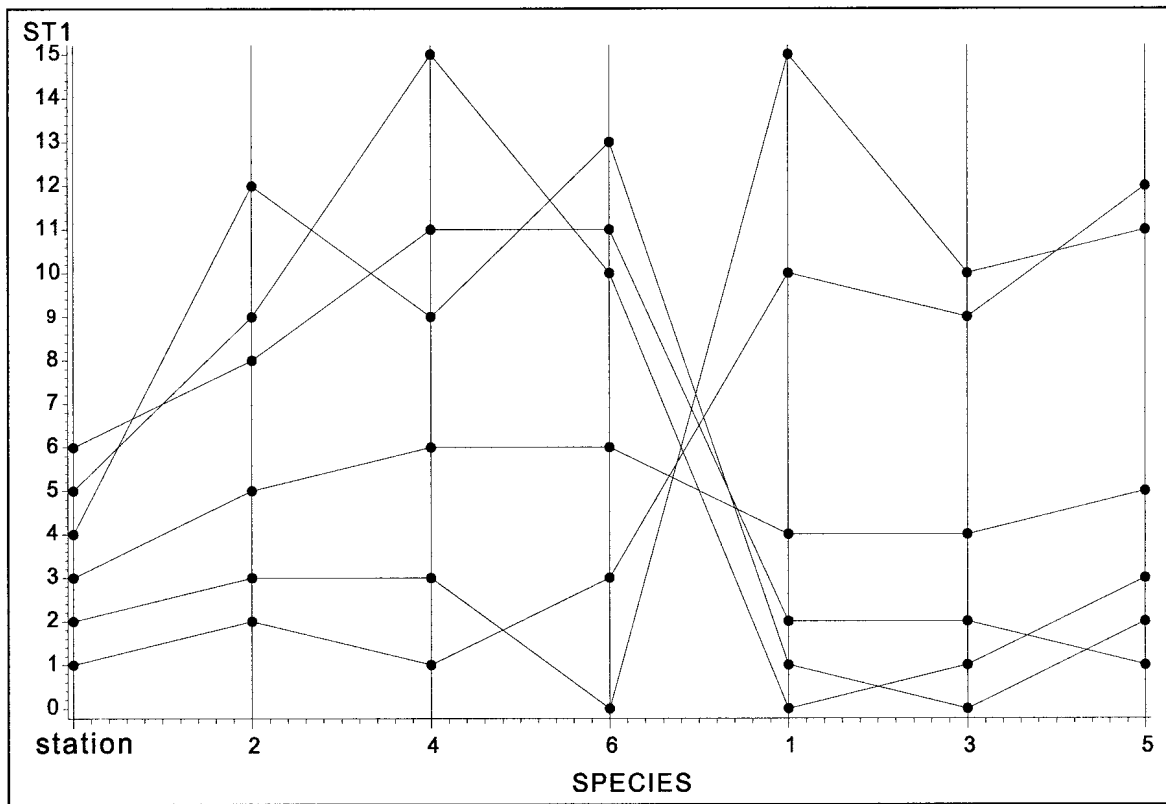

**Figure 3-3**  
Multivariate data displayed in parallel axis graph.

FREQUENCY of SPECIES

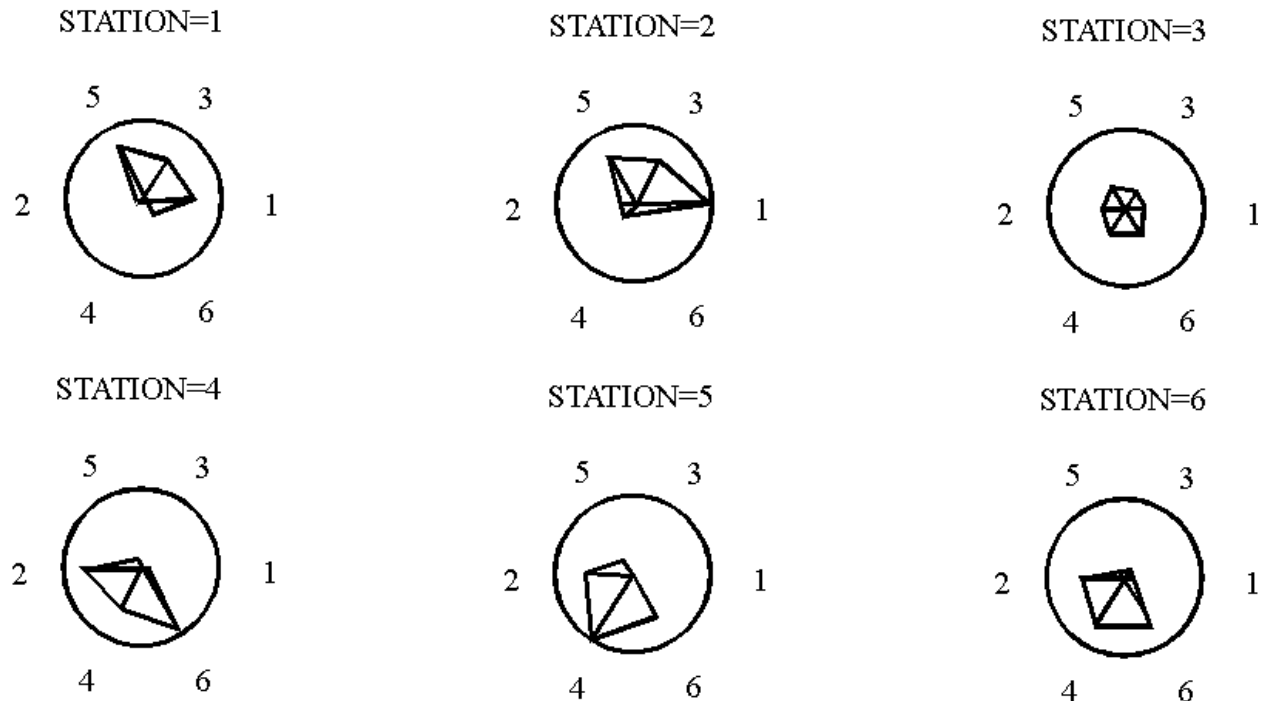
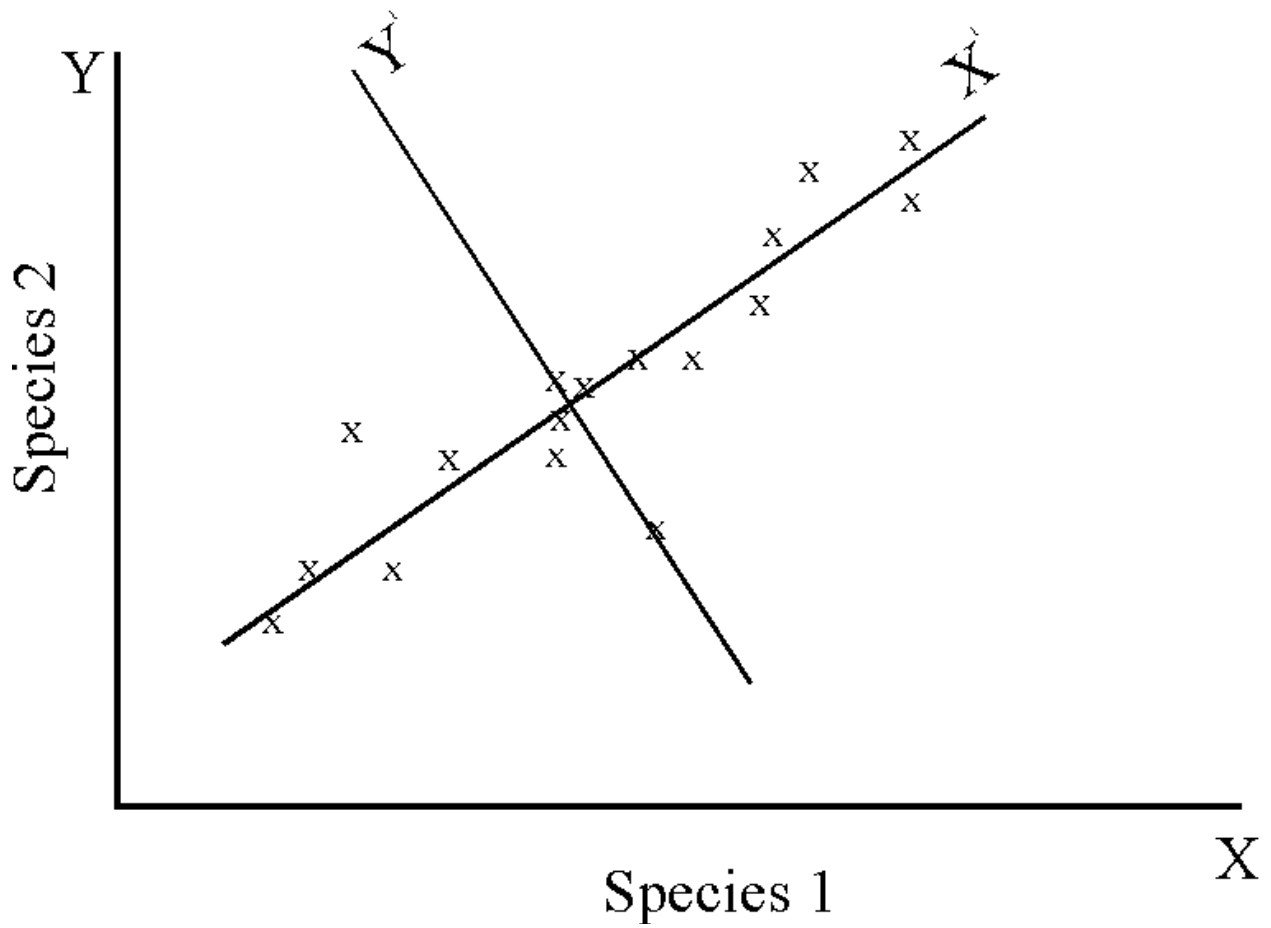

Figure 3-4  
Multivariate data displayed in star graph.



**Figure 3-5**  
Illustration of the concept of principle component analysis for a two dimensional data set.

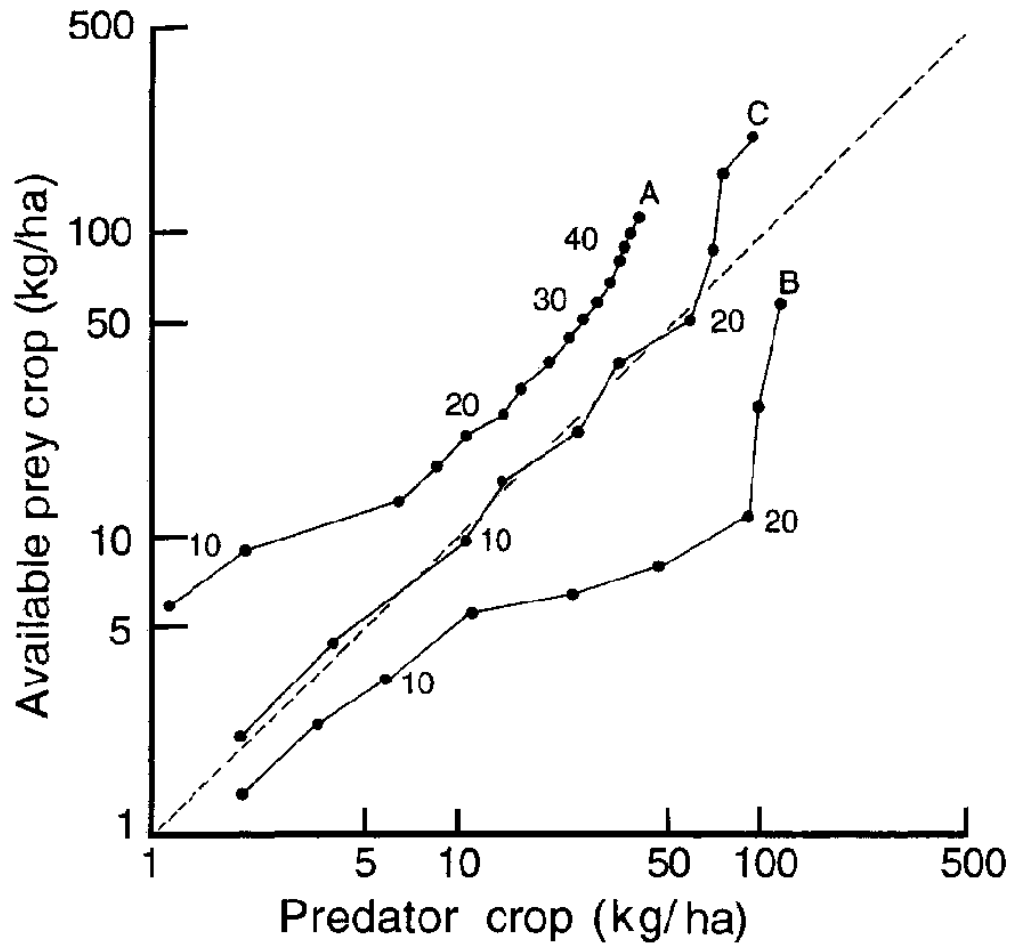

Figure 3-6  
 Logarithmic plots of available prey:predator (AP/P) for three general conditions: (A) excess prey for all lengths of predators; (B) prey deficiencies for all lengths of predators; and (C) prey adequacy for small predators but excess for large predators (>20 cm). Diagonal dashed line indicates the minimum desirable AP/P ratio. Numbers along the curves are predator lengths (cm), and points represent 2.5-cm length increments. From Anderson and Neuman (1996) based upon Jenkins and Morais (1978) and Noble (1981).

**Table 3-1  
Index of Biotic Integrity (IBI) (also RBP Fish Assessments)**

Type of question/issue addressed	(1) Is the waterbody healthy, of good quality and integrity; (2) To what (relative) degree; (3) What kind of stressors are indicated (if any)?
Data input requirements	Fish community sampling data for test sites and reference conditions for a minimum of one season
Inherent assumptions	An acceptable reference condition, or control site, and regional scoring criteria are available. (Acceptable reference assumes that habitat is generally similar among sites or that scoring criteria can compensate for the differences).
Scope of methods	Method measures the balance and integrity of the fish community at a single point in time, but can make inferences about long-term water quality stressors. Far-field or near-field analysis.
Taxa applicability	This is a fish community technique, predominantly for wadeable freshwater rivers/streams.
Peer review and/or use in regulatory setting	The original methods of Karr (1981) and Karr et al. (1986) have been widely reviewed and applied. Region-specific modifications have been or are being developed all the time. Biocriteria for fish are just beginning to be used in state water quality criteria.
Level of expertise required	Advanced knowledge of freshwater fisheries
Relative cost to use	A relatively inexpensive technique if regional expectations (scoring criteria) have already been defined. If required, regional criteria development is costly and time consuming.
Nature of results	Results are a combination of qualitative and quantitative metrics. The index yields a value for the fish community at a particular site that can be evaluated against habitat and/or reference conditions to make an assessment about the degree of impairment.
Relationship to other methods	The IBI is an integral part of the RBP. It has also provided the basis of other multi-metric fish assessment techniques such as I <sup>2</sup> and RAIF.



**Table 3-2**  
**Example of Trophic Group and Tolerance Designation of Selected Fish Species**

Species	Trophic Group(a)	References(b)	Tolerance Group(c)	References(b)
Carp and Minnows				
Central stoneroller	Herbivore	1,2,3,4,5	--	1,2,3,4,5
Spotfin shiner	Insectivore	1,2,3,5	--	1,2,3,5
Common shiner	Insectivore	1,2,3,5	--	1,2,3,5
River chub	Insectivore	1,3,5	Intolerant	1,3,5
Golden shiner	Omnivore	1,2,4,5	Tolerant	3,5
Suckers				
White sucker	Omnivore	3,4,5	--	1,2,4
Creek chubsucker	Insectivore	2,3,5	--	2,3,5
Bullhead catfishes				
Yellow bullhead	Insectivore	1,2,3,4,5	Tolerant	3,5
Brown bullhead	Insectivore	1,2,3,4,5	Tolerant	3,5
Trouts				
Brown trout	Insectivore/piscivore	1,5	--	3,5
Brook trout	Insectivore/piscivore	1,5	--	3,5

- (a) Category definitions as described by Karr et al. (1986): herbivore or planktivore = 75 percent of the diet is plant material or plankton; insectivore = 75 percent of the diet is insects and insect larvae; omnivore = at least 25 percent of the diet is plant material and 25 percent is animal material; piscivore = diet is primarily fish.
- (b) 1 = U.S. EPA (1983); 2 = Karr et al. (1986); 3 = Ohio EPA (1987); 4 = Allen (1989); 5 = U.S. EPA (1989).
- (c) Intolerant classification: restricted to those species that are most susceptible/sensitive to major types of degradation or perturbation (i.e., habitat or water quality degradation). Tolerant classification: restricted to species that are least sensitive to habitat and/or water quality degradation (often present in moderate numbers, but can become dominant in degraded locations).

**Table 3-3 Fish IBI Metrics Used in Various Regions of North America**

Alternative IBI metrics	A	B	C	D	E	F	G	H
1. Total number of species	X	X		X	X		X	
# Native fish species	X		X			X		X
# Salmonid age classes <sup>a</sup>					X	X		
2. Number of darter species	X			X	X			
# Sculpin species						X		
# Benthic insectivore species								
# Darter and sculpin species	X	X						
# Salmonid yearlings (individuals) <sup>a</sup>		X				X	X	
% Round-bodied suckers	X							
# Sculpins (individuals)							X	
3. Number of sunfish species	X				X			X
# Cyprinid species						X		
# Water column species		X						
# Sunfish and trout species			X					
# Salmonid species							X	
# Headwater species	X							
4. Number of sucker species	X	X				X		X
# Adult trout species <sup>a</sup>						X	X	
# Minnow species	X				X			
# Sucker and catfish species			X					
5. Number of intolerant species	X	X			X	X		X
# Sensitive species	X							
# Amphibian species							X	
Presence of brook trout			X					
6. % Green sunfish	X							
% Common carp						X		
% White sucker		X			X			
% Tolerant species	X							X
% Creek chub				X				
% Dace species			X					
7. % Omnivores	X	X	X	X	X			X
% Yearling salmonids <sup>a</sup>					X	X		
8. % Insectivorous cyprinids	X							
% Insectivores		X				X		X
% Specialized insectivores				X	X			
# Juvenile trout							X	
% Insectivorous species	X							
9. % Top Carnivores	X	X	X					X
% Catchable salmonids						X		
% Catchable trout							X	
% Pioneering species	X							
Density catchable wild trout							X	
10. Number of individuals	X		X	X	X	X	X	X <sup>b</sup>
Density of individuals		X						
11. % Hybrids	X	X						
% Introduced species					X	X		
% Simple lithophills	X							X
# Simple lithophills species	X							
% Native species							X	
% Native wild individuals							X	
12. % Diseased individuals	X	X	X	X	X	X		X

Note: X = metric used in region. Many of these variations are applicable elsewhere.

Key: A, Midwest; B, New England; C, Ontario; D, Central Appalachia; E, Colorado Front Range; F, Western Oregon; G, Sacramento-San Joaquin; H, Wisconsin.

<sup>a</sup> Metric suggested by Moyle or Hughes as a provisional replacement metric in small western salmonid streams.

<sup>b</sup> Excluding individuals of tolerant species.

Taken from Karr et al. (1986), Hughes and Gammon (1987), Ohio EPA (1987a,b), Miller et al. (1988), Steedman (1988), and Lyons (1992).

**Table 3-4**  
**Family Level Ichthyoplankton Index Methods (I<sup>2</sup>)**

Type of question/issue addressed	Does a known or suspected water quality stressor impact the quality and integrity of the larval fish community? To what (relative) degree?
Data input requirements	Ichthyoplankton sampling data for test sites and reference conditions for a minimum of one season (preferably summer).
Inherent assumptions	An acceptable reference site and regional scoring criteria are available. Also assumes that habitat is generally similar among sites or that scoring criteria can compensate for the differences. Larval fish are more sensitive to some water quality stressors than adult fish.
Scope of methods	Method screens the balance and integrity of the larval fish community at a single point in time, but can make inferences about long-term water quality stressors.
Taxa applicability	This is a larval fish community technique, exclusive to freshwater.
Peer review and/or use in regulatory setting	The basic method is published in U.S. EPA 1993. It has not been widely used in a regulatory setting.
Level of expertise required	Knowledge of freshwater larval fish taxonomy. Advanced knowledge of fish reproductive cycles and ecology.
Relative cost to use	A moderately expensive technique if regional expectations (scoring criteria) have already been defined. If necessary, regional criteria development is costly and time consuming.
Nature of results	Results are a combination of qualitative and quantitative metrics. The index yields an index for the larval fish community at a particular site that can be evaluated against habitat and/or reference conditions to make an assessment about the degree of impairment.
Relationship to other methods	Similar to the fish IBI.

**Table 3-5  
Reservoir Fish Assemblage Index (RFAI)**

Type of question/issue addressed	(1) Is the waterbody healthy, of good quality and integrity; (2) To what (relative) degree?; (3) What kind of stressors are indicated (if any)?
Data input requirements	Fish community sampling data for test sites and reliable reference conditions.
Inherent assumptions	Reference site or conditions (and scoring criteria). Can be based upon historical data if it includes wide range of conditions. (Acceptable reference assumes that habitat is grossly similar among sites or that scoring criteria can compensate for the differences).
Scope of methods	Method measures the balance and integrity of the fish community at a single point in time, but can make inferences about long-term water quality stressors. Normally far-field, can be near-field.
Taxa applicability	This is a fish community technique for freshwater reservoirs.
Peer review and/or use in regulatory setting	Hickman and McDonough 1996. Developed, tested, and utilized in Tennessee River Valley reservoirs. Currently being evaluated in other systems, including regulatory settings.
Level of expertise required	Basic knowledge of freshwater fisheries.
Relative cost to use	A low cost if regional expectations (scoring criteria) have already been defined. If required, regional criteria development may be costly and time consuming.
Nature of results	Results are a combination of qualitative and quantitative metrics. The index yields a value for the fish community at a particular site that can be evaluated against reference conditions/sites to make an assessment about the degree of impairment or community balance.
Relationship to other methods	This method is a direct adaptation of the fish IBI for wadeable streams.

**Table 3-6**  
**Index of Well-Being (IWB) and Modified IWB**

Type of question/issue addressed	Does a known or suspected water quality stressor impact the quality of the fish community? To what (relative) degree?
Data input requirements	Fish community sampling data for test sites for a minimum of one season (preferably summer). Reference site data preferable, but not required.
Inherent assumptions	High abundances of tolerant species decrease overall taxa richness. Diversity Indices compensate for this difference in most cases. Uniformly excluding tolerant taxa from some calculations does not alter relative ratings among stations.
Scope of methods	Method measures the balance of the fish community at a single point in time, but can make inferences about long-term water quality stressors.
Taxa applicability	This is a fish community technique, predominantly for freshwater rivers/streams.
Peer review and/or use in regulatory setting	The original methods of Gammon 1976 have been modified by Gammon 1980 and Yoder et al. 1981 to compensate for insensitivities in communities with nutrient enrichment and moderate taxa richness. Used in Ohio as a regulatory tool. Not as widely used as the IBI.
Level of expertise required	Basic knowledge of freshwater fisheries.
Relative cost to use	A relatively inexpensive technique which utilizes biosurvey data from other assessments (such as the IBI).
Nature of results	Results are a combination of qualitative and quantitative metrics. The index yields a value for the fish community at a particular site that can be evaluated against habitat and/or reference conditions to make an assessment about the degree of impairment.
Relationship to other methods	Used in conjunction with the fish IBI. Shannon Diversity index is an integral part of the calculation.

**Table 3-7**  
**Sport Fishing Index (SFI)**

Type of question/issue addressed	What is the expected quality of the sportfishing experience at a given reservoir in a particular year?
Data input requirements	Population quality/quantity and creel survey data for the reservoirs and sportfish species of concern
Inherent assumptions	Several years of reference data have been collected in order to develop scoring criteria.
Scope of methods	Method measures the quality of individual species fishing in lakes and reservoirs.
Taxa applicability	This is a sportfish population assessment technique for freshwater lakes and reservoirs.
Peer review and/or use in regulatory setting	Draft TVA (Hickman 1997) methodology. Not yet peer reviewed. Has been used in a regulatory setting in Tennessee Valley.
Level of expertise required	Advanced knowledge of freshwater fisheries, fisheries management.
Relative cost to use	Inexpensive if fishery management data available, otherwise somewhat expensive during development of regional expectations (scoring criteria).
Nature of results	Based upon basic fisheries statistics. The index yields a value for a given sport fish population for a given year. Results geared toward the resource manager and angler.
Relationship to other methods	Basic multi-metric technique that derives many of it's metrics from fisheries population assessment techniques (e.g. PSD, RSD)

**Table 3-8**  
**Rapid Bioassessment: Invertebrate Protocols (Single and Multihabitat Approaches)**

Type of question/issue addressed	(1) Is the waterbody healthy, of good quality and integrity; (2) To what (relative) degree; (3) What kind of stressors are indicated (if any)?
Data input requirements	Qualitative benthic community sampling data for test sites and reference conditions for a minimum of one season (preferably spring/summer).
Inherent assumptions	Acceptable regional reference conditions and scoring criteria are available. (Acceptable reference assumes that habitat is grossly similar among sites or that scoring criteria can compensate for the differences).
Scope of methods	Method measures the balance and integrity of the benthic community at a single point in time, but can make inferences about long-term water quality stressors.
Taxa applicability	This is a benthic invertebrate community technique, predominantly for freshwater rivers/streams.
Peer review and/or use in regulatory setting	The original methods of U.S. EPA 1989 have been widely reviewed and applied. Region-specific modifications have been or are being developed all the time. The current protocol is draft but has been applied in various forms throughout the country for years.
Level of expertise required	Basic knowledge of freshwater benthic identification and ecology plus some mathematics.
Relative cost to use	A relatively inexpensive technique if regional reference conditions have already been defined. If required, reference conditions development is costly and time consuming.
Nature of results	Results are a combination of qualitative and quantitative metrics which yield a total value for the benthic community at a particular site that can be evaluated against habitat and/or reference conditions to make an assessment about the degree of impairment.
Relationship to other methods	The benthic RBP Protocol is the basis for other multi-metric benthic and algal assessment approaches.

**Table 3-8 (continued)**

Type of question/issue addressed	Does a known or suspected water quality stressor have an impact on the quality and integrity of the benthic community? To what (relative) degree?
----------------------------------	---



**Table 3-9**  
**Examples of Metric Suites Used for Analysis of Macroinvertebrate Assemblages**

Alternative benthic metrics	ICI <sup>a</sup>	RBP <sup>b</sup>	RBP <sup>c</sup>	RBP <sup>d</sup>			B-IBI <sup>e</sup>
				ID	OR	WA	
1. Total No. Taxa	X	X	X	X	X	X	X
% Change in Total Taxa Richness				X	X	X	
2. No. EPT Taxa	X	X		X	X	X	
No. Mayfly Taxa	X						X
No. Caddisfly Taxa	X						X
No. Stonefly Taxa							X
Missing Taxa (EPT)			X				
3. No. Diptera Taxa	X						
No. of Chironomidae Taxa				X		X	
4. No. Intolerant Snail and Mussel Species							X
5. Ratio EPT/Chironomidae Abund				X	X	X	
Indicator Assemblage Index			X	X	X		
% EPT Taxa				X			
% Mayfly Composition	X						
% Caddisfly Composition	X						
6. % Tribe Tanytarsini	X						
7. % Other Diptera and Noninsect Composition	X						
8. % Tolerant Organisms	X						
% Corbicula Composition							X
% Oligochaete Composition							X
Ratio Hydropsychidae/Tricoptera		X			X		
9. % Ind. Dominant Taxon		X		X	X	X	
% Ind. Two Dominant Taxa							X
Five Dominant Taxa in Common		X	X		X		
Common Taxa Index			X				
10. Indicator Groups				X		X	
11. % Ind. Omnivores and Scavengers							X
12. % Ind. Collector Gatherers and Filterers							X
% Ind. Filterers				X		X	
13. % Ind. Grazers and Scrapers				X			X
Ratio Scrapers/Filterer Collectors				X	X	X	
Ratio Scrapers/(Scrapers + Filterer Collectors)		X					
14. % Ind. Strict Predators							X
15. Ratio Shredders/Total Ind. (% shredders)		X		X		X	
16. % Similarity Functional Feeding Groups (QSI)		X	X				
17. Total Abundance				X			
18. Pinkham-Pearson Community Similarity Index		X					
Community Loss Index					X	X	
Jaccard Similarity Index				X			
19. Quantitative Similarity Index (Taxa)		X	X				
20. Hilsenhoff Biotic Index		X		X	X	X	
Chandler Biotic Score				X			
21. Shannon-Weiner Diversity Index					X		
Equitability				X			
Index of Community Integrity				X			

<sup>a</sup> Invertebrate Community Index, Ohio EPA (1987b, DeShon (Chapter 15)).

<sup>b</sup> Rapid Bioassessment Protocols, Barbour et al. (1992) revised from Plafkin et al. (1989).

<sup>c</sup> Rapid Bioassessment Protocols, Shackelford (1988).

<sup>d</sup> Rapid Bioassessment Protocols, Hayslip (1993); ID = Idaho, OR = Oregon, WA = Washington.  
 (Note: these metrics in ID, OR, and WA are currently under evaluation).

<sup>e</sup> Benthic Index of Biotic Integrity, Kerans et al. (1992).

**Table 3-10**  
**Rapid Bioassessment: Biological Reconnaissance (BioRecon)**

Type of question/issue addressed	Does a known or suspected water quality stressor impact the quality and integrity of the fish community? Which sites need more intensive investigation?
Data input requirements	Qualitative benthic community sampling data for test sites and reference conditions for a minimum of one season (preferably spring/summer).
Inherent assumptions	The presence/absence of pollution sensitive benthic species is indicative of water quality perturbations. Gross habitat degradations will affect benthic community integrity.
Scope of methods	Method screens the current conditions of the benthic community. Inferences about the degree of stress or impairment can not be made with this level of investigation.
Taxa applicability	This is a benthic invertebrate community screening technique, predominantly for freshwater rivers/streams.
Peer review and/or use in regulatory setting	The original methods of U.S. EPA 1989 have been widely reviewed. The current protocol is draft but have been in use in Florida for several years.
Level of expertise required	Basic knowledge of freshwater benthic identification and ecology.
Relative cost to use	A very inexpensive technique that is best used to screen a large number of sites with potential water quality problems.

**Table 3-11**  
**Hilsenhoff Biotic Index**

Type of question/issue addressed	Is organic pollution (enrichment) among the key stressors to a benthic community? To what (relative) degree?
Data input requirements	Quantitative benthic community sampling data for test sites and reference conditions for a minimum of one season (preferably spring/summer).
Inherent assumptions	Acceptable regional tolerance values are available. Organic pollution is among the key concerns at the test sites.
Scope of methods	Method measures the tolerance of the arthropod component of the benthic community to organic pollution. It is typically a component of multimetric assessment approaches.
Taxa applicability	This is a benthic arthropod assessment technique, for freshwater rivers/streams.
Peer review and/or use in regulatory setting	The methods of Hilsenhoff 1977 have been modified by Hilsenhoff (1987) and used widely. Region-specific tolerance values have been derived and published. It was incorporated into the multimetric approaches of U.S. EPA (1989).
Level of expertise required	Good working knowledge of freshwater benthic identification and ecology.
Relative cost to use	An inexpensive technique if regional tolerance values have been established.
Nature of results	Results are non-statistical and qualitative. The resulting index can give a relative evaluation of the organic pollution tolerance (integrity) of the benthic community.
Relationship to other methods	Used as one of the preferred metrics for RBP Protocol II and III evaluations in some regions.

**Table 3-12  
Invertebrate Community Index (ICI)**

Type of question/issue addressed	(1) Is the waterbody healthy, of good quality and integrity; (2) To what (relative) degree; (3) What kind of stressors are indicated (if any)?
Data input requirements	Quantitative benthic community sampling data for test sites and reference conditions for a minimum of one season.
Inherent assumptions	This technique was developed specifically for streams and rivers in Ohio. As such, reference conditions have been established. Use outside of Ohio would require regional adaptation of the metrics.
Scope of methods	Method measures the balance and integrity of the benthic community at a single point in time, but can make inferences about long-term water quality stressors.
Taxa applicability	This is a benthic invertebrate community technique, predominantly for freshwater rivers/streams.
Peer review and/or use in regulatory setting	Has been used to established water quality-based surface water standards within the state of Ohio.
Level of expertise required	Good working knowledge of freshwater benthic identification and ecology plus.
Relative cost to use	A relatively inexpensive technique if established reference conditions and scoring criteria are applicable to the test site.
Nature of results	Results are largely non-statistical but because field collections include replication, statistical methods can be applied to the data. The resulting metrics yield a value for the benthic community at a particular site that can be evaluated against habitat and/or reference conditions to make an assessment about the degree of impairment.
Relationship to other methods	This is a derivation of the benthic RBP Protocols II & III and the general techniques of the IBI.

**Table 3-13**  
**Benthic IBI for Chesapeake Bay (B-IBI)**

Type of question/issue addressed	Does a known or suspected water quality stressor impact the quality and integrity of the benthic community? To what (relative) degree? Is the naturally occurring benthic community already limited by available habitat quality (e.g. low DO at depth)?
Data input requirements	Quantitative benthic community sampling data for test sites and reference sites for a minimum of one season (preferably spring/summer). Salinity and grain-size data also needed.
Inherent assumptions	This technique was developed specifically for Chesapeake Bay. It assumes that benthic communities throughout the bay are similar in similar salinity and bottom types.
Scope of methods	Method measures the balance and integrity of the benthic community at a single point in time, but can make inferences about long-term water quality stressors.
Taxa applicability	This is a benthic community technique specific to estuarine portions of the Chesapeake Bay.
Peer review and/or use in regulatory setting	The original methods of Ranasinghe et al (1994 a & b) have been revised and published by Weisberg et al. 1997. It is just beginning to be used within the region, but has gained general acceptance by much of the regulatory community.
Level of expertise required	Good working knowledge of estuarine benthic identification and ecology.
Relative cost to use	A moderately inexpensive technique because reference conditions have been developed.
Nature of results	Results are largely non-statistical but because field collections include replication, statistical methods can be applied to the data. The resulting metrics yield a value for the benthic community at a particular site that can be evaluated against reference conditions to make an assessment about the degree of impairment.
Relationship to other methods	This is a derivation of the benthic RBP Protocols II & III and the general techniques of the IBI.

**Table 3-14  
MACS Workshop Method**

Type of question/issue addressed	Does a known or suspected water quality stressor impact the quality and integrity of the benthic community? To what (relative) degree?
Data input requirements	Qualitative benthic community sampling data for test sites and reference conditions for a minimum of one season (preferably spring/summer).
Inherent assumptions	Acceptable regional reference conditions and scoring criteria are available. Also assumes that habitat is grossly similar among sites or that scoring criteria can compensate for the differences.
Scope of methods	Method measures the balance and integrity of the benthic community at a single point in time, but can make inferences about long-term water quality stressors.
Taxa applicability	This is a benthic community technique specifically for coastal plain streams in the mid-Atlantic region.
Peer review and/or use in regulatory setting	This modification of the benthic RBP is in the early stages of development and has not yet been peer reviewed or widely applied. Some specific states participating in development have well established (and reviewed) modifications of the RBP in use within their states.
Level of expertise required	Good working knowledge of freshwater benthic identification and ecology.
Relative cost to use	Will be a moderately inexpensive technique in areas where regional reference conditions have already been defined.
Nature of results	Results are largely non-statistical. The resulting metrics yield a value for the benthic community at a particular site that can be evaluated against habitat and/or reference conditions to make an assessment about the degree of impairment.
Relationship to other methods	Derivation of the benthic RBP Protocol II with region- and state-specific modifications for coastal plain conditions (specifically habitat) from Delaware to South Carolina.

**Table 3-15**  
**Fish Health Assessments**

Type of question/issue addressed	Does a known or suspected water quality stressor impact the quality of a fish population? To what (relative) degree?
Data input requirements	Fish examination data including general condition, blood-factor evaluations, and necropsy-based organ and tissue evaluations.
Inherent assumptions	Fish within the test population respond within the expected norm (for most fish species) to a known or suspected stressor. Expected norms must be established. Stressor is extensive enough to overcome fish mobility.
Scope of methods	Method measures the health and condition of individual fish within a population to make inferences regarding how well a population is supported by habitat conditions. Could be used to measure chronic or subchronic effects of stressors.
Taxa applicability	This is a fisheries population technique, predominantly for freshwater rivers/streams, although it could be generally applied to any fish population where expected norms have been established.
Peer review and/or use in regulatory setting	The original methods of Goede 1992 and Goede and Barton 1990 have been adopted by U.S. EPA (1993). This is predominantly a management technique and no regulatory applications were found.
Level of expertise required	In-depth knowledge of fish anatomy. Specific training required.
Relative cost to use	A moderately expensive technique because a minimum number of fish are necessary for statistical power and the individual assessments are reasonably complex and time consuming.
Nature of results	A single index is not derived. Individual metrics are tracked through time and can be evaluated against the expected norms. Provides a snapshot of current conditions within a drainage area.
Relationship to other methods	Fish Health Assessments metrics utilize some standard stock assessment techniques.

**Table 3-16**  
**Rapid Bioassessment: Algal Assessments (Periphyton)**

Type of question/issue addressed	(1) Is the waterbody healthy, of good quality and integrity; (2) To what (relative) degree; (3) What kind of stressors are indicated (if any)?
Data input requirements	Qualitative periphyton sampling data for test sites and reference conditions for a minimum of one season (preferably spring/summer during stable stream flows).
Inherent assumptions	Acceptable regional reference site. (Acceptable reference assumes that habitat is grossly similar among sites or that scoring criteria can compensate for the differences).
Scope of methods	Method measures the balance and integrity of the periphyton community at a single point in time, but can make inferences about long-term water quality stressors.
Taxa applicability	This is exclusively a freshwater periphyton technique for rivers/streams.
Peer review and/or use in regulatory setting	Several states have included protocols for periphyton monitoring (KY, MT, and OK). Some of the original protocol development was conducted by Rosen (1995).
Level of expertise required	Advanced knowledge of freshwater algae identification and ecology plus some mathematics.
Relative cost to use	A moderately expensive technique due to the lab processing time.
Nature of results	Results are a combination of qualitative and quantitative metrics which yield a total value for the algal index value be evaluated against habitat and/or reference conditions to make an assessment about the degree of impairment.
Relationship to other methods	The periphyton protocol is a modification of the benthic RBP Protocol.
Type of question/issue addressed	Does a known or suspected water quality stressor have an impact on the quality and integrity of the periphyton community? To what (relative) degree?



**Table 3-17**  
**Summary of Method Characteristics: T-Test**

Type of questions/issues addressed	Designed to assess to assess differences in response between two groups such as impact and reference.
Data input requirements	Replicated observations with two groups
Inherent assumptions	Assumes that deviations about the means are i.i.d. $N(0,s)$ (see text for explanation). Full examination of assumptions may be time consuming. If assumptions are satisfied, it is the uniformly most powerful test.
Scope of method	This procedure has power to detect differences in means between groups.
Taxa applicability	This procedure may be applied to all metrics.
Peer review and/or use in regulatory setting	Widely used for comparing means.
Level of expertise required	Basic understanding of hypothesis testing concepts. Easy to implement.
Relative cost to use	Widely available in software packages.
Nature of results	Results are quantitative and support objective comparisons

**Table 3-18**  
**Summary of Method Characteristics: Paired T-Test**

Type of questions/issues addressed	Designed to assess differences in response between two groups such as impact and reference when the observations are paired by another factor such as sample date.
Data input requirements	Replications of paired observations.
Inherent assumptions	Assumes that deviations about the means are i.i.d. $N(0,s)$ (see text for explanation). Full examination of assumptions may be time consuming. If assumptions are satisfied, it is the uniformly most powerful test.
Scope of method	This procedure has power to detect differences in means between groups while eliminating the variation due to the pairing factor.
Taxa applicability	This procedure may be applied to all metrics.
Peer review and/or use in regulatory setting	Widely used for comparing means.
Level of expertise required	Basic understanding of hypothesis testing concepts.
Relative cost to use	Widely available in software packages. Easy to implement.
Nature of results	Results are quantitative and support objective comparisons

**Table 3-19**  
**Summary of Method Characteristics: ANOVA**

Type of questions/issues addressed	Designed to assess differences in response among several groups such as nearfield, farfield, and reference.
Data input requirements	Replicated observations within several groups
Inherent assumptions	Assumes that deviations about the means are i.i.d. $N(0,s)$ (see text for explanation). Full examination of assumptions may be time consuming. If assumptions are satisfied, it is the uniformly most powerful test.
Scope of method	This procedure has power to detect differences in means among groups.
Taxa applicability	This procedure may be applied to all metrics.
Peer review and/or use in regulatory setting	Widely used for comparing means.
Level of expertise required	Basic understanding of hypothesis testing concepts.
Relative cost to use	Widely available in software packages. Easy to implement.
Nature of results	Results are quantitative and support objective comparisons

**Table 3-20**  
**Summary of Method Characteristics: Randomized Block Analysis**

Type of questions/issues addressed	Designed to assess differences in response among groups that are blocked by another factor such as date.
Data input requirements	Replications of three or more treatments in blocks.
Inherent assumptions	Assumes that deviations about the means are i.i.d. $N(0,s)$ (see text for explanation). Full examination of assumptions may be time consuming. If assumptions are satisfied, it is the uniformly most powerful test.
Scope of method	This procedure has power to detect differences in means among groups.
Taxa applicability	This procedure may be applied to all metrics.
Peer review and/or use in regulatory setting	Widely used for comparing means.
Level of expertise required	Basic understanding of hypothesis testing concepts.
Relative cost to use	Widely available in software packages. A full examination of assumptions can be time consuming. Easy to implement.
Nature of results	Results are quantitative and support objective comparisons

**Table 3-21**  
**Summary of Method Characteristics: Factorial ANOVA**

Type of questions/issues addressed	Designed to assess to assess differences in response between two groups such as impact and reference.
Data input requirements	Replicated observations within groups defined by cross classifying two or more factors.
Inherent assumptions	Assumes that deviations about the means are i.i.d. $N(0,s)$ (see text for explanation). Full examination of assumptions may be time consuming. If assumptions are satisfied, it is the uniformly most powerful test.
Scope of method	This procedure has power to detect differences in means among groups.
Taxa applicability	This procedure may be applied to all metrics.
Peer review and/or use in regulatory setting	Widely used for comparing means.
Level of expertise required	Basic understanding of hypothesis testing concepts and full understanding of linear models.
Relative cost to use	Widely available in software packages. A full examination of assumptions can be time consuming. As model grow in complexity, interpretation becomes difficult. Very efficient in that replication is increased by adding treatments if additivity holds. Easy to implement.
Nature of results	Results are quantitative and support objective comparisons

**Table 3-22**  
**Summary of Method Characteristics: Split Plot ANOVA**

Type of questions/issues addressed	Designed to assess differences in response among treatments applied within experimental units on one level and among experimental units on another level.
Data input requirements	One level of treatments applied to experimental unit that are further subdivided and treated by another level of treatments.
Inherent assumptions	Assumes that deviations about the means are i.i.d. $N(0,s)$ (see text for explanation) on the whole unit and the sub unit levels. If assumptions are satisfied, it is the uniformly most powerful test.
Scope of method	This procedure has power to detect differences in means among groups defined by a complex treatment structure.
Taxa applicability	This procedure may be applied to all metrics.
Peer review and/or use in regulatory setting	Use is limited because of sophisticated design requirements.
Level of expertise required	Expert understanding of hypothesis testing and experimental design concepts. Design and execution are complex, but it may be required to correctly model a complex system.
Relative cost to use	Available in better software packages. A full examination of assumptions can be time consuming.
Nature of results	Results are quantitative and support objective comparisons

**Table 3-23**  
**Summary of Method Characteristics: Repeated Measures ANOVA**

Type of questions/issues addressed	Designed to assess differences in response among treatments applied within experimental units on one level and among experimental units on another level.
Data input requirements	One level of treatments applied to experimental units with measurements taken repeatedly (multiple times or multiple locations).
Inherent assumptions	Assumes that deviations about the means are i.i.d. $N(0,s)$ (see text for explanation) on the whole unit and the sub unit levels. If assumptions are satisfied, it is the uniformly most powerful test.
Scope of method	This procedure has power to detect differences in means among groups defined by a complex treatment structure.
Taxa applicability	This procedure may be applied to all metrics.
Peer review and/or use in regulatory setting	Use is limited because of sophisticated design requirements.
Level of expertise required	Expert understanding of hypothesis testing and experimental design concepts. Design and execution are complex, but it may be required to correctly model a complex system.
Relative cost to use	Available in better software packages. A full examination of assumptions can be time consuming.
Nature of results	Results are quantitative and support objective comparisons

**Table 3-24**  
**Summary of Method Characteristics: MANOVA**

Type of questions/issues addressed	Designed to assess differences in responses among several groups such as nearfield, farfield, and reference for vector observations.
Data input requirements	Replicated vector observations within several groups
Inherent assumptions	Assumes that deviations about the means are i.i.d. multivariate $N(0,S)$ (see text for explanation). Full examination of assumptions may be time consuming. If assumptions are satisfied, it is the uniformly most powerful test. May expose differences that are not discernable by univariate analysis.
Scope of method	This procedure has power to detect differences in vector centroids among groups.
Taxa applicability	This procedure may be applied to all multivariate metrics.
Peer review and/or use in regulatory setting	Infrequently used for comparing means because of complexity.
Level of expertise required	Expert understanding of hypothesis testing and multivariate distributions.
Relative cost to use	Available in comprehensive statistics packages. A full examination of assumptions can be time consuming.
Nature of results	Results are quantitative and support objective comparisons



**Table 3-25**  
**Summary of Method Characteristics: ANCOVA**

Type of questions/issues addressed	Designed to assess differences in responses among several groups such as nearfield, farfield, and reference and at the same time adjust for nuisance variables such as salinity.
Data input requirements	Replicated observations within two or more groups. A dependent and a continuous independent variable are measured for each replicate.
Inherent assumptions	Assumes that deviations about the means are i.i.d. $N(0,s)$ (see text for explanation). Typically it is assumed that the dependent variable is a linear function of the independent variable. Full examination of assumptions may be time consuming. If assumptions are satisfied, it is the uniformly most powerful test.
Scope of method	This procedure has power to detect differences in means among groups after adjusting for the variance associated with the covariate.
Taxa applicability	This procedure may be applied to all metrics.
Peer review and/or use in regulatory setting	If assumptions are met then its validity is undisputed.
Level of expertise required	Expert understanding of hypothesis testing concepts and linear models.
Relative cost to use	Available in comprehensive statistics packages. Easy to implement. A full examination of assumptions can be time consuming.
Nature of results	Results are quantitative and support objective comparisons

**Table 3-26**  
**Summary of Method Characteristics: Wilcoxon Rank Sum Test**

Type of questions/issues addressed	Designed to assess differences in response between two groups such as impact, and reference.
Data input requirements	Replicated observations within two groups
Inherent assumptions	Assumes data come from a continuous distribution. If data are not $N(0,s)$ , it may have greater power than normal theory competitor.
Scope of method	This procedure has power to detect differences in median among groups.
Taxa applicability	This procedure may be applied to all metrics.
Peer review and/or use in regulatory setting	Less frequently used than parametric competitors.
Level of expertise required	Basic understanding of hypothesis testing concepts.
Relative cost to use	Available in comprehensive statistics packages. Efficient to use because of limited assumptions. Easy to implement.
Nature of results	Results are quantitative and support objective comparisons

**Table 3-27**  
**Summary of Method Characteristics: Sign Test**

Type of questions/issues addressed	Designed to assess differences in response between two groups such as impact, and reference.
Data input requirements	Replicated observations within two groups
Inherent assumptions	Assumes data come from a continuous distribution.
Scope of method	This procedure has power to detect differences in median between groups.
Taxa applicability	This procedure may be applied to all metrics.
Peer review and/or use in regulatory setting	Infrequently used because of low power.
Level of expertise required	Basic understanding of hypothesis testing concepts. Easy to implement.
Relative cost to use	Easy to compute without electronic computing resources. Efficient to use because of limited assumptions.
Nature of results	Results are quantitative and support objective comparisons

**Table 3-28**  
**Summary of Method Characteristics: Wilcoxon Signed Rank Test**

Type of questions/issues addressed	Designed to assess differences in response between two groups such as impact, and reference when data are paired by another factor such as sample date.
Data input requirements	Replicated pairs of observations
Inherent assumptions	Assumes the difference between members of pair has a continuous and symmetric distribution. If data are not $N(0,s)$ , it may have greater power than normal theory competitor.
Scope of method	This procedure has power to detect differences in median among groups.
Taxa applicability	This procedure may be applied to all metrics.
Peer review and/or use in regulatory setting	Less frequently used than parametric competitors.
Level of expertise required	Basic understanding of hypothesis testing concepts. Easy to implement.
Relative cost to use	Available in comprehensive statistics packages. Efficient to use because of limited assumptions.
Nature of results	Results are quantitative and support objective comparisons

**Table 3-29**  
**Summary of Method Characteristics: Kruskal Wallis Test**

Type of questions/issues addressed	Designed to assess differences in response among groups such as impact, nearfield, farfield, and reference.
Data input requirements	Replicated observations within several groups
Inherent assumptions	Assumes data come from a continuous distribution. If data are not $N(0,s)$ , it may have greater power than normal theory competitor.
Scope of method	This procedure has power to detect differences in median among groups.
Taxa applicability	This procedure may be applied to all metrics.
Peer review and/or use in regulatory setting	Less frequently used than parametric competitors.
Level of expertise required	Basic understanding of hypothesis testing concepts. Easy to implement.
Relative cost to use	Available in comprehensive statistics packages. Efficient to use because of limited assumptions.
Nature of results	Results are quantitative and support objective comparisons

**Table 3-30**  
**Summary of Method Characteristics: Friedman Test**

Type of questions/issues addressed	Designed to assess differences in response between several groups such as impact, nearfield and reference which are blocked by another factor such as sample date.
Data input requirements	Replicates observations of several treatments applied within blocks.
Inherent assumptions	Assumes data come from a continuous distribution. If data are not $N(0,s)$ , it may have greater power than normal theory competitor.
Scope of method	This procedure has power to detect differences in median among groups.
Taxa applicability	This procedure may be applied to all metrics.
Peer review and/or use in regulatory setting	Less frequently used than parametric competitors.
Level of expertise required	Basic understanding of hypothesis testing concepts. Easy to implement.
Relative cost to use	Available in comprehensive statistics packages. Efficient to use because of limited assumptions.
Nature of results	Results are quantitative and support objective comparisons

**Table 3-31**  
**Summary of Method Characteristics: ANOVA of Ranks**

Type of questions/issues addressed	Designed to assess differences in response between several groups such as impact, nearfield, and reference.
Data input requirements	Can be applied for any data that are designed for Analysis of Variance.
Inherent assumptions	An ad hoc procedure for which the assumptions are not completely clear.
Scope of method	This procedure has power to detect differences in median among groups.
Taxa applicability	This procedure may be applied to all metrics.
Peer review and/or use in regulatory setting	Appears to work satisfactorily but its validity for all models is not established.
Level of expertise required	Basic understanding of hypothesis testing concepts. Easy to implement.
Relative cost to use	Available in comprehensive statistics packages. Efficient to use because of limited assumptions.
Nature of results	Results are quantitative and support objective comparisons. Relative power is not known.

**Table 3-32**  
**Summary of Method Characteristics: Randomization Tests**

Type of questions/issues addressed	Designed to assess independence of two variables.
Data input requirements	Can be applied to almost any data where one variable can be randomized with respect to another.
Inherent assumptions	Assumptions are minimal. Even some forms of dependence are tolerated. If data are not $N(0,s)$ , it may have greater power than normal theory competitor.
Scope of method	This procedure has power to detect whether one variable is independent of another.
Taxa applicability	This procedure may be applied to all metrics.
Peer review and/or use in regulatory setting	Less frequently used than parametric competitors.
Level of expertise required	Basic understanding of hypothesis testing concepts.
Relative cost to use	Often requires custom programming. Efficient to use because of limited assumptions. Moderate computing power required (a personal computer). May be difficult to implement.
Nature of results	Results are quantitative and support objective comparisons



**Table 3-33**  
**Summary of Method Characteristics: Bootstrapping**

Type of questions/issues addressed	Designed to for estimating precision.
Data input requirements	Replicated observations
Inherent assumptions	Observations are independent. If data are not $N(0,s)$ , it may have greater power than normal theory competitor.
Scope of method	This procedure is used to compute variance estimated that may subsequently be used for testing hypotheses.
Taxa applicability	This procedure may be applied to all metrics.
Peer review and/or use in regulatory setting	Less frequently used than parametric competitors.
Level of expertise required	Basic understanding of hypothesis testing concepts and sampling with replacement.
Relative cost to use	May require custom programming and moderate computing power. Efficient to use because of limited assumptions. Easy to implement.
Nature of results	Results are quantitative and support objective comparisons

**Table 3-34**  
**Summary of Method Characteristics: Test for Proportions**

Type of questions/issues addressed	Designed to assess differences in a binary response rate between two groups such as survival at impact, and reference sites.
Data input requirements	Replicated observations of a binary event within two groups
Inherent assumptions	Assumes data are independent observations from a binomial distribution. Not effective with small sample sizes.
Scope of method	This procedure has power to detect differences in proportions among groups.
Taxa applicability	This procedure may be applied to binary data.
Peer review and/or use in regulatory setting	Widely used and accepted.
Level of expertise required	Basic understanding of hypothesis testing concepts.
Relative cost to use	Available in comprehensive statistics packages. Easy to implement even without computing power.
Nature of results	Results are quantitative and support objective comparisons

**Table 3-35**  
**Summary of Method Characteristics: Fisher's Exact Test**

Type of questions/issues addressed	Designed to assess differences in a binary response rate between two groups such as survival at impact, and reference sites.
Data input requirements	Replicated observations of a binary event within two groups
Inherent assumptions	Assumes data are independent observations from a binomial distribution. Not effective with small sample sizes and considered prone to type II errors (false negatives).
Scope of method	This procedure has power to detect differences in proportions among groups.
Taxa applicability	This procedure may be applied to binary data.
Peer review and/or use in regulatory setting	Widely used and accepted.
Level of expertise required	Basic understanding of hypothesis testing concepts.
Relative cost to use	Available in comprehensive statistics packages.
Nature of results	Results are quantitative and support objective comparisons

**Table 3-36**  
**Summary of Method Characteristics: 2-Way Chi-Square Test**

Type of questions/issues addressed	Designed to test if responses for one factor are independent of a second factor.
Data input requirements	Replicated observations of items that can be classified in a 2 way table.
Inherent assumptions	Not effective with small sample sizes. This test works well for any frequency distribution when expected cell counts are greater than 5.
Scope of method	This procedure has power to detect independence of two factors forming the table.
Taxa applicability	This procedure may be applied to frequency data.
Peer review and/or use in regulatory setting	Widely used and accepted.
Level of expertise required	Basic understanding of hypothesis testing concepts.
Relative cost to use	Available in comprehensive statistics packages.
Nature of results	Results are quantitative and support objective comparisons

**Table 3-37**  
**Summary of Method Characteristics: Multiway Chi-Square Test**

Type of questions/issues addressed	Designed to test if responses for one factor are independent of a second factor.
Data input requirements	Replicated observations of items that can be classified in a Multiway table.
Inherent assumptions	This test works well for any frequency distribution when expected cell counts are greater than 5. Not effective with small sample sizes.
Scope of method	This procedure has power to detect independence of two factors forming the table.
Taxa applicability	This procedure may be applied to frequency data.
Peer review and/or use in regulatory setting	Widely used and accepted.
Level of expertise required	Basic understanding of hypothesis testing concepts.
Relative cost to use	Available in comprehensive statistics packages.
Nature of results	Results are quantitative and support objective comparisons

**Table 3-38**  
**Summary of Method Characteristics: Log-Linear Models**

Type of questions/issues addressed	Designed to model discrete data by complex linear models.
Data input requirements	Replicated observations of items whose response is thought to be a function of a linear model.
Inherent assumptions	This procedure relies on asymptotic convergence to a Chi-square distribution and therefore requires large sample sizes. Not effective with small sample sizes.
Scope of method	This procedure has power to detect associations between discrete response variables and either continuous or discrete independent variables.
Taxa applicability	This procedure may be applied to frequency data.
Peer review and/or use in regulatory setting	Widely used and accepted.
Level of expertise required	Expert understanding of hypothesis testing concepts, linear modeling, and asymptotic statistics.
Relative cost to use	Available in comprehensive statistics packages.
Nature of results	Results are quantitative and support objective comparisons

**Table 3-39**  
**Summary of Method Characteristics: Mann-Kendall Test**

Type of questions/issues addressed	Designed to assess trends in any continuous data with a minimum of assumptions about the distribution of the data.
Data input requirements	A simple time series of data.
Inherent assumptions	Assumes data are independent observations from a continuous distribution.
Scope of method	This procedure has power to detect monotonic trends, linear and non-linear.
Taxa applicability	Any species for which data are available.
Peer review and/or use in regulatory setting	Widely used by the USGS for assessing trends in water quality data; use in power-plant regulatory settings unknown
Level of expertise required	Basic understanding of hypothesis testing concepts.
Relative cost to use	Once software for this test are acquired, it is easy to execute and interpret. This methodology is not as widely available in software packages as other trend test.
Nature of results	Results are quantitative and support objective comparisons
Relationship to other methods	Relative to other methods, this test is easy to implement because it requires a minimum of assumptions that must be verified. The model includes a term for trend only and is cannot be expanded to include other factors. Can have greater power than normal theory tests if data are not normal.

**Table 3-40**  
**Summary of Method Characteristics: Seasonal Kendall Test**

Type of questions/issues addressed	Designed to assess trends in any continuous data with a minimum of assumptions about the distribution of the data.
Data input requirements	A time series of data with multiple years ( $\geq 3$ ) and a cyclical seasonal component.
Inherent assumptions	Assumes data are independent observations from a continuous distribution and that the trend is the same for each season. The procedure provides a test for the homogeneity of trend assumption.
Scope of method	This procedure has power to detect monotonic trends, linear and non-linear.
Taxa applicability	Any species for which data are available.
Peer review and/or use in regulatory setting	Widely used by the USGS for assessing trends in water quality data; use in power-plant regulatory settings unknown.
Level of expertise required	Basic understanding of hypothesis testing concepts.
Relative cost to use	Once software for this test are acquired, it is easy to execute and interpret. This methodology is not as widely available in software packages as other trend tests.
Nature of results	Results are quantitative and support objective comparisons.
Relationship to other methods	Relative to other methods, this test is easy to implement because it requires a minimum of assumptions that must be verified. The model includes terms for trend and season and it cannot be expanded to include other factors. Can have greater power than normal theory tests if data are not normal.



**Table 3-41**  
**Summary of Method Characteristics: Van Belle and Huges Test**

Type of questions/issues addressed	Designed to assess trends in any continuous data with a minimum of assumptions about the distribution of the data.
Data input requirements	Three or more years of time series data with a seasonal component at multiple locations.
Inherent assumptions	Assumes data are independent observations from a continuous distribution. Procedure will test assumptions of homogeneity of trend among locations and seasons.
Scope of method	This procedure has power to detect monotonic trends, linear and non-linear.
Taxa applicability	Any species for which data are available.
Peer review and/or use in regulatory setting	Widely used by the USGS for assessing trends in water quality data; use in power-plant regulatory settings unknown.
Level of expertise required	Basic understanding of hypothesis testing concepts.
Relative cost to use	Once software for this test are acquired, it is easy to execute and interpret. This methodology is not as widely available in software packages as other trend test.
Nature of results	Results are quantitative and support objective comparisons.
Relationship to other methods	Relative to other methods, this test is easy to implement because it requires a minimum of assumptions that must be verified. The model includes season and location as factors but cannot be extended to include other factors. Can have greater power than normal theory tests if data are not normal.

**Table 3-42**  
**Summary of Method Characteristics: Simple Linear Regression**

Type of questions/issues addressed	Designed to assess trends in any continuous data where the assumptions of independence, linearity, and constant variance can be verified.
Data input requirements	A series of observations on a dependent variable which are considered to be a linear function of an independent variable (e.g., time or space).
Inherent assumptions	Assumes data are independent observations from a normal distribution with constant variance.
Scope of method	This procedure has power to detect linear trends.
Taxa applicability	Any species for which data are available.
Peer review and/or use in regulatory setting	This is a long established method that is widely available and widely used for detecting trends.
Level of expertise required	Basic understanding of linear models and hypothesis testing concepts.
Relative cost to use	Simplest of all trend methods to implement because the method is widely available in software packages. A full examination of the assumptions of this method entails some labor and interpretation.
Nature of results	Results are quantitative and support objective comparisons. Interpretation is enhanced by graphical display.
Relationship to other methods	Relative to other methods, this test is widely available. It is often used without adequate verification of the assumptions. The linear model is easily expanded to include other factors. If the assumptions are met, it is the uniformly most powerful test of the null hypothesis of no trend.

**Table 3-43**  
**Summary of Method Characteristics: Multiple Linear Regression**

Type of questions/issues addressed	Designed to assess trends in any continuous data where the assumptions of independence, linearity, and constant variance can be verified.
Data input requirements	A series of observations on a dependent variable which are considered to be linearly related to several independent variables.
Inherent assumptions	Assumes dependent variable data are independent observations from a normal distribution with constant variance.
Scope of method	This procedure has power to detect linear trends with several variables.
Taxa applicability	Any species for which data are available.
Peer review and/or use in regulatory setting	This is a long established method that is widely available and widely used for detecting trends.
Level of expertise required	Basic understanding of linear models, hypothesis testing concepts, and interpretation of the effects collinear independent variables.
Relative cost to use	An extension of simple linear regression, MLR is also widely available in software packages and easy to implement. A full examination of the assumptions will increase the cost of it's use.
Nature of results	Results are quantitative and support objective comparisons. Interpretation is enhanced by graphical display.
Relationship to other methods	Relative to other methods, this test is widely available. It is often used without adequate verification of the assumptions. If the assumptions are met, it is a powerful test of the null hypothesis of no trend.

**Table 3-44**  
**Summary of Method Characteristics: Polynomial Regression**

Type of questions/issues addressed	Designed to assess trends in any continuous data where the assumptions of independence, model fit, and constant variance can be verified.
Data input requirements	A series of observations on a dependent variable which are considered to be a curvilinear function of an independent variable.
Inherent assumptions	Assumes data are independent observations from a normal distribution with constant variance.
Scope of method	This procedure has power to detect trends that can be approximated by a low order polynomial.
Taxa applicability	Any species for which data are available.
Peer review and/or use in regulatory setting	This is a long established method that is widely available and widely used for detecting trends.
Level of expertise required	Basic understanding of polynomial equations and hypothesis testing concepts.
Relative cost to use	A special case of MLR, this method is widely available in software packages. A full examination of the assumptions will increase the cost of it's use.
Nature of results	Results are quantitative and support objective comparisons. Interpretation is enhanced by graphical display.
Relationship to other methods	Relative to other methods, this test is widely available. If the assumptions are met, it is a powerful test of the null hypothesis of no trend.

**Table 3-45**  
**Summary of Method Characteristics: Multivariate Regression**

Type of questions/issues addressed	Designed to assess trends in any continuous vectors where the assumptions of independence, linearity, and homogeneous variance-covariance can be verified.
Data input requirements	A series of observations on a dependent vector (two or more variables) which are a function of concomitantly measured independent variables.
Inherent assumptions	Assumes data are independent observations from a multivariate normal distribution with constant variance-covariance structure.
Scope of method	This procedure extends other regression methods by allowing for dependence among components of the vector.
Taxa applicability	Any species for which data are available.
Peer review and/or use in regulatory setting	This procedure is available only in well developed statistics packages and no examples of use in power station assessment were found.
Level of expertise required	Understanding of multivariate distribution theory and regression analysis.
Relative cost to use	The method requires extensive interpretation of results and verification of assumptions.
Nature of results	Results are quantitative and support objective comparisons.
Relationship to other methods	This method has the advantage of reducing the risk of type I error that results from a series of univariate analyses. If the assumptions are met, it is a powerful test of the null hypothesis of no trend.

**Table 3-46**  
**Summary of Method Characteristics: Time Series Methods**

Type of questions/issues addressed	Designed to assess trends in any continuous data where the assumptions can be verified.
Data input requirements	A series of observations on a dependent variable which is changing over time and may be influenced by other variables.
Inherent assumptions	Assumes data are from a normal distribution with covariance stationarity. Usually this is taken to mean that data must be equally spaced in time.
Scope of method	This procedure extends other regression methods by relaxing the need for independence.
Taxa applicability	Any species for which data are available.
Peer review and/or use in regulatory setting	Widely used by economists. Less frequently used in environmental venues.
Level of expertise required	Requires specialized training in time series methods.
Relative cost to use	Model development and interpretation are labor intensive.
Nature of results	Results are quantitative and support objective comparisons. Interpretation is enhanced by graphical display.
Relationship to other methods	This method has the advantage that data need not be independent, and is otherwise similar to regression methods.

**Table 3-47**  
**Summary of Method Characteristics: Cluster Analysis**

Type of questions/issues addressed	Useful for assessing the similarity of sites as described by their community structure.
Data input requirements	A collection of items to be grouped according to a vector of variables.
Inherent assumptions	No required assumptions. It is generally desirable for the distance measure to satisfy the triangle inequality.
Scope of method	This procedure will group items according to similarity of associated variables. This procedure has the advantage of simultaneously evaluating many dimensions of a community but the interpretation of the results are subjective.
Taxa applicability	This procedure may be applied to all metrics.
Peer review and/or use in regulatory setting	Widely used by ecologists for community assessment. Use in power-plant regulatory settings unknown
Level of expertise required	Understanding of distance and similarity measures.
Relative cost to use	Interpretation is time consuming.
Nature of results	Results are quantitative but lack specific hypotheses. Therefore the interpretation is subjective. No objective rules for choosing similarity measures or scaling procedures.

**Table 3-48**  
**Summary of Method Characteristics: Multivariate Graphical Methods**

Type of questions/issues addressed	Useful for assessing the similarity of sites as described by their community structure.
Data input requirements	A collection of items to be grouped according to a vector of variables.
Inherent assumptions	No required assumptions.
Scope of method	These procedures allow the user to discern patterns in the data.
Taxa applicability	This procedure may be applied to all metrics.
Peer review and/or use in regulatory setting	Apparently not widely known or used.
Level of expertise required	Understanding of ecological principals that create patterns in data.
Relative cost to use	Interpretation is time consuming.
Nature of results	Interpretation is subjective.
Relationship to other methods	This procedure has the advantage of simultaneously evaluating many dimensions of a community but the interpretation of the results are subjective. More easily understood than complex mathematical multivariate methods.



**Table 3-49**  
**Summary of Method Characteristics: Principal Components Analysis**

Type of questions/issues addressed	Useful for identifying variables that exhibit similar patterns across stations or time.
Data input requirements	A collection of observations each described by a vector of variables.
Inherent assumptions	The analysis is a simple algebraic manipulation and thus no assumptions are required. Interpretation may require that underlying exogenous variables are forcing several responses to vary in concert.
Scope of method	This procedure determines which variables in a data set covary.
Taxa applicability	This procedure may be applied to all metrics.
Peer review and/or use in regulatory setting	Widely used by ecologists for community assessment. Use in power-plant regulatory settings unknown.
Level of expertise required	Understanding of multivariate correlation.
Relative cost to use	Interpretation is time consuming.
Nature of results	Results are quantitative but lack specific hypotheses. Therefore the interpretation is subjective.
Relationship to other methods	This procedure has the advantage of simultaneously evaluating many dimensions of a community but the interpretation of the results are subjective. Often used as a precursor to other methods such as regression or ordination.

**Table 3-50**  
**Summary of Method Characteristics: Factor Analysis**

Type of questions/issues addressed	Useful for identifying variables that exhibit similar patterns across stations or time.
Data input requirements	A collection of observations each described by a vector of variables.
Inherent assumptions	The analysis is a complex algebraic manipulation and no assumptions are required. Interpretation may require that underlying exogenous variables are forcing several responses to vary in concert.
Scope of method	This procedure determines which variables in a data set covary.
Taxa applicability	This procedure may be applied to all metrics.
Peer review and/or use in regulatory setting	Widely used in psychometrics, rarely used by ecologists or in power-plant assessment.
Level of expertise required	Understanding of multivariate correlation and higher dimensional geometry.
Relative cost to use	Interpretation is time consuming.
Nature of results	Results are quantitative lacks of specific hypotheses. Therefore the interpretation is subjective.
Relationship to other methods	This procedure has the advantage of simultaneously evaluating many dimensions of a community but the interpretation of the results are subjective.

**Table 3-51**  
**Summary of Method Characteristics: Ordination**

Type of questions/issues addressed	Useful for identifying variables that exhibit similar patterns across stations or time.
Data input requirements	A collection of observations each described by a vector of variables.
Inherent assumptions	The analysis is an algebraic manipulation and thus no assumptions are required. Interpretation may require that underlying exogenous variables of forcing several response to vary in concert.
Scope of method	This procedure determines which variables in a data set covary to define community structure and examines patterns in the community structure over space or time.
Taxa applicability	This procedure may be applied to all metrics.
Peer review and/or use in regulatory setting	Widely used by ecologists for community assessment. Use in power-plant regulatory settings unknown
Level of expertise required	Understanding of multivariate correlation.
Relative cost to use	Interpretation is time consuming.
Nature of results	Results are quantitative but lack specific hypotheses. Therefore the interpretation is subjective.
Relationship to other methods	This procedure has the advantage of simultaneously evaluating many dimensions of a community but the interpretation of the results are subjective. Useful for identifying a community level response to a gradient.

**Table 3-52**  
**Summary of Method Characteristics: Canonical Correlation**

Type of questions/issues addressed	This procedure is useful for evaluating many dimensions of a community in relation to many dimensions of its physical environment.
Data input requirements	A collection of observations each described by a vector of variables. Typically the variables fall into two groups such as biological and physical.
Inherent assumptions	If used for hypothesis testing, it is assumed that the data are multivariate normal.
Scope of method	Used to determine a multiple correlation coefficient between two sets of variables.
Taxa applicability	This procedure may be applied to all metrics.
Peer review and/or use in regulatory setting	Widely used by ecologists for community assessment. Use in power-plant regulatory settings unknown
Level of expertise required	Understanding of multivariate correlation.
Relative cost to use	Interpretation is time consuming. Method is available in comprehensive statistics packages.
Nature of results	Results are quantitative and test the hypothesis that the variables of set A are associated with the variables of set B. It does not identify specific cause and effect pathways.
Relationship to other methods	Used as a stand alone method or as a precursor to evaluating individual correlations between biological and physical variables.

**Table 3-53**  
**Summary of Method Characteristics: Discriminant Analysis**

Type of questions/issues addressed	This procedure is useful for identifying the important discriminating variables between two sets of observations such as impact and reference.
Data input requirements	A collection of observations each described by a vector of variables. One of the variables identifies groups of observations.
Inherent assumptions	If used for hypothesis testing, it is assumed that the data are multivariate normal.
Scope of method	Used to determine what variables are best for differentiating groups of observations.
Taxa applicability	This procedure may be applied to all metrics.
Peer review and/or use in regulatory setting	Widely used by ecologists for community assessment. Use in power-plant regulatory settings unknown
Level of expertise required	Understanding of multivariate correlation.
Relative cost to use	Interpretation is time consuming. Method is available in comprehensive statistics packages.
Nature of results	Results are quantitative and support objective comparisons
Relationship to other methods	Used as a stand alone assessment or for identifying important metrics for follow up analysis.

**Table 3-54**  
**Summary of Method Characteristics: Available Prey/Predator Ratio (AP/P)**

Type of questions/issues addressed	Designed to assess prey-predator abundance in relation to optima or minima for quality fishing for the predator species
Data input requirements	Accurate assessments of biomass of both prey and predator species; in practice, will require individual lengths and weights of prey specie(s), and individual or batch weight of predator species
Inherent assumptions	Assumes 1:1 AP/P ratio is minimum desirable value
Scope of method	Method directed at evaluating predator population level, typically largemouth bass; could be expanded to fish community assessment
Taxa applicability	Largemouth bass as predator (or other species converted to "largemouth bass equivalents") in existing applications; other predators could be evaluated with additional research
Peer review and/or use in regulatory setting	Several applications published in peer review literature; use in power-plant regulatory settings unknown
Level of expertise required	Basic fishery biologist training
Relative cost to use	Moderate; requires labor-intensive field work, but may be employed with other sampling/analysis programs, thus producing efficiencies
Nature of results	Results are quantitative and support objective comparisons
Relationship to other methods	Generally similar to various other predator-prey fisheries assessments

**Table 3-55**  
**Summary of Method Characteristics: Young/Adult Ratio (YAR)**

Type of questions/issues addressed	Addresses the “balance” of a fish population
Data input requirements	Number of young and adults in a species population (or relative unbiased sample from the population)
Inherent assumptions	YAR outside of 1 - 3:1 range suggest imbalance in population
Scope of method	Method directed at population level; YAR evaluation of multiple species could be expanded to fish community assessment
Taxa applicability	Any species for which unbiased samples of number of young and adult can be obtained
Peer review and/or use in regulatory setting	Peer review publication minimal; use in power-plant regulatory settings apparently few (one example in text)
Level of expertise required	Basic fishery biologist training
Relative cost to use	Moderate; requires labor-intensive field work, but may be employed with other sampling/analysis programs, thus producing efficiencies
Nature of results	Results are quantitative and support objective comparisons
Relationship to other methods	A variation of length-frequency index specific to game fish

**Table 3-56**  
**Summary of Method Characteristics: Proportional Stock Density (PSD)**

Type of questions/issues addressed	Addresses the “balance” of a fish population
Data input requirements	Accurate sampling and length measurements for target species; designation of “stock,” “quality,” and other length categories as appropriate
Inherent assumptions	Length-frequency data are accurate means of describing population “balance”
Scope of method	Method directed at sport fish population level
Taxa applicability	Any game species for which “stock” and “quality” length categories have been designated
Peer review and/or use in regulatory setting	Peer-reviewed applications relatively common over last 20 years; use in power-plant regulatory settings apparently few (one example in text)
Level of expertise required	Basic fishery biologist training
Relative cost to use	Moderate; requires labor-intensive field work, but may be employed with other sampling/analysis programs, thus producing efficiencies
Nature of results	Results are quantitative and support objective comparisons
Relationship to other methods	A variation of length-frequency index specific to game fish



**Table 3-57**  
**Summary of Method Characteristics: Relative Stock Density (RSD)**

Type of questions/issues addressed	Addresses the “balance” of a fish population
Data input requirements	Accurate sampling and determination of length measurements; designation of “stock,” “quality,” and other length categories as appropriate
Inherent assumptions	Length-frequency data are accurate means of describing population “balance”
Scope of method	Method directed at sport fish population level
Taxa applicability	Any game species for which “stock,” “quality,” “preferred,” and/or other appropriate length categories have been designated
Peer review and/or use in regulatory setting	Peer-reviewed applications relatively common over last 20 years; use in power-plant regulatory settings apparently few
Level of expertise required	Basic fishery biologist training
Relative cost to use	Moderate; requires labor-intensive field work, but may be employed with other sampling/analysis programs, thus producing efficiencies
Nature of results	Results are quantitative and support objective comparisons
Relationship to other methods	A variation of length-frequency index specific to game fish

**Table 3-58**  
**Summary of Method Characteristics: Relative Weight**

Type of questions/issues addressed	Assesses the health or well-being of a specific fish population relative to the “standard” length-specific standard weight for that population
Data input requirements	Individual fish length and weight measurements; determination of length-specific standard weights (Ws)
Inherent assumptions	Ws describes the inherent shape of a fish that is in good condition
Scope of method	Data collection at individual level; conclusions drawn to population level
Taxa applicability	All fish taxa for which Ws equations have been published
Peer review and/or use in regulatory setting	Descriptions, applications, and critiques common in peer review literature; text example provided of use by Commonwealth Edison in power-plant monitoring
Level of expertise required	Basic fishery biologist training
Relative cost to use	Moderate; requires labor-intensive field work, but may be employed with other sampling/analysis programs, thus producing efficiencies
Nature of results	Results are quantitative and support objective comparisons
Relationship to other methods	Method is derivation of earlier Condition, or Ponderal Indices

# 4

## REFERENCES

---

- Aber, J. 1997. Why don't we believe the models? *Bull. Ecol. Soc. Amer.* 78:232-233.
- Aber, J. 1998. Mostly a misunderstanding, I believe. *ESA Bulletin* 79(4):256-257.
- Adams, S.M., and M.G. Ryon. 1994. A comparison of health assessment approaches for evaluating the effects of contaminant-related stress on fish populations. *J. Aquat. Ecosystem Health* 3:15-25.
- Adams, S.M., W.D. Crumby, M.S. Greeley, M.G. Ryon, and E.M. Schilling. 1992. Relationships between physiological and fish population responses in a contaminated stream. *Environ. Toxicol. Chem.* 11:1549-1557.
- Adams, S.M., A.M. Brown, and R.W. Goede. 1993. A quantitative health assessment index for rapid evaluation of fish condition in the field. *Trans. Am. Fish. Soc.* 122:63-73.
- Adler, R.W. 1995. Filling the gaps in water quality standards: legal perspectives on biocriteria, in *Biological Assessment and Criteria: Tools for Water Resource Planning and Decision Making* (W.S. Davis and P.P. Simon, eds.), pp. 345-358. Lewis Publishers, Boca Raton, Florida.
- Alevras, R.A., C.B. Dew, E.K. Pikitch, R.L. Wyman, J.P. Lawler, R.A. Norris, and S.L. Weiss. 1980. Methodology for Assessing Population and Ecosystem Level Effects Related to Intake of Cooling Waters. Volume 1: Handbook of Methods, Population Level Techniques. Prepared by Lawler, Matusky and Skelly Engineers, Pearl River, New York. Prepared for Electric Power Research Institute, Palo Alto, California. EPRI Report EA-1402, Volume 1.
- Allan, J.D., and R.E. Daniels. 1982. Life table evaluation of chronic exposure of *Eurytemora affinis* (Copepoda) to kepone. *Mar. Biol.* 66:179-184.
- Allen, S.M. 1989. The Adaptation of an Index of Biotic Integrity to Streams of the Coastal Plain Drainage Basins in North Carolina. M.S. Thesis. Duke University School of Forestry and Environmental Studies.

- Anderson, R.O. 1975. Factors influencing the quality of largemouth bass fishing, *in Black Bass Biology and Management* (R.H. Stroud and H. Clepper, eds.), pp. 183-194. Sport Fishing Institute, Washington, DC.
- Anderson, R.O. 1976. Management of small warmwater impoundments. *Fisheries* 1 (6): 5-7, 26-28.
- Anderson, R.O. 1978. New approaches to recreational fisheries management, *in New Approaches to the Management of Small Impoundments* (G.D. Novinger and J.G. Dillard, eds.), pp. 73-78. Special Publication 5, North Central Division, American Fisheries Society, Bethesda, Maryland.
- Anderson, R.O. 1980. Proportional stock density (PSD) and relative weight ( $W_r$ ): Interpretive indices for fish populations and communities, *in Practical Fisheries Management: More With Less in the 1980's*, pp. 27-33. Workshop Proceedings, New York Chapter, American Fisheries Society, Ithaca, New York.
- Anderson, R.O., and R.M. Neumann. 1996. Length, weight, and associated structural indices, *in Fisheries Techniques*, pp. 447-482. Second Edition. American Fisheries Society, Bethesda, Maryland.
- Anderson, R.O., and A.S. Weithman. 1978. The concept of balance for coolwater fish populations, *in Selected Coolwater Fishes of North America* (R.L. Kendell, ed.), pp. 371-381. Special Publication 11. American Fisheries Society, Bethesda, Maryland.
- Ardisson, P. L., E. Bourget, and P. Legendre. 1990. Multivariate approach to study species assemblages at large spatiotemporal scales: The community structure of the epibenthic fauna of the estuary and gulf of St. Lawrence. *Can. J. Fish. Aquat. Sci.* 47:1364-1377.
- Atomic Industrial Forum, Inc. 1978. A Document Collection of Electric Utility Studies Related to Cooling System Effects on Water Quality and Aquatic Biota. EPRI EA-872, Project 877-1, Special Report. August.
- Ball, J. 1982. Stream Classification Guidelines for Wisconsin. Technical Bulletin A2-A30. Department of Natural Resources, Madison, Wisconsin.
- Barbour, M.T., and J.B. Stribling. 1991. Use of habitat assessment in evaluating the biological integrity of stream communities. *in Biological Criteria: Research and Regulation, Proceedings of a Symposium, 12-13 December 1990, Arlington, Virginia*. EPA-440-5-91-005. Office of Water, U.S. Environmental Protection Agency, Washington, D.C.

- Barbour, M.T., C.G. Graves, and W.L. McCulloch. 1989. Evaluation of the Intrinsic Rate of Increase as an Endpoint for Ceriodaphnia Chronic Tests. American Society for Testing and Materials. pp. 273-288.
- Barbour, M.T., J.B. Stribling, and J.R. Karr. 1995. Multimetric approach for establishing biocriteria and measuring biological condition, *in* *Biological Assessment and Criteria: Tools for Water Resource Planning and Decision Making* (W.S. Davis and T.P. Simon, eds.), pp. 63-77. Lewis Publishers, Boca Raton, Florida.
- Barnthouse, L.W., and W. Van Winkle. 1988. Analysis of impingement impacts on Hudson River fish populations, *in* *Science, Law, and Hudson River Power Plants: A Case Study in Environmental Impact Assessment*, pp. 182-190. American Fisheries Society, Bethesda, Maryland.
- Barnthouse, L.W., D.L. DeAngelis, and S.W. Christensen. 1979. An Empirical Model of Impingement Impact. Environmental Sciences Division Publication No. 1289. Prepared for the U.S. Nuclear Regulatory Commission.
- Barnthouse, L.W., R.J. Klauda, D.S. Vaughan, and R.L. Kendall, eds. 1988. *Science, Law, and Hudson River Power Plants: A Case Study in Environmental Impact Assessment*. American Fisheries Society, Bethesda, Maryland.
- Barnthouse, L.W., G.W. Suter II, and A.E. Rosen. 1990. Risks of toxic contaminants to exploited fish populations: Influence of life history, data uncertainty, and exploitation intensity. *Environ. Toxicol. Chem.* 9:297-311.
- Bartell, S.M., R.H. Gardner, and R.V. O'Neill. 1992. *Ecological Risk Estimation*. Lewis Publishers, Boca Raton.
- Battelle Pacific Northwest Laboratories. 1979. Synthesis and Analysis of Ecological Information From Cooling Impoundments. Prepared for Electric Power Research Institute. EPRI EA-1054, Research Project 880. Final Report. 2 volumes. April.
- Bennett, D.H. 1972. Length-weight relationships and condition factors of fish from a South Carolina reservoir receiving thermal effluent. *Prog. Fish-Culturist* 34(2):85-87.
- Beverton, R.J.H., and S.H. Holt. 1957. *On the Dynamics of Exploited Fish Population*. Her Majesty's Stationery Office, London.
- Bishop, Y.M.M., S.E. Fienberg and P.W. Holland. 1975. *Discrete Multivariate Analysis: Theory and Practice*. MIT Press, Cambridge, Massachusetts. 557 pp.

- Bode, R.W., and M. A. Novak. 1995. Development and application of biological impairment criteria for rivers and streams in New York State. *in Biological Assessment and Criteria: Tools for Water Resource Planning and Decision Making* (W.S. Davis and P.P. Simon, eds.), pp. 97-108. Lewis Publishers, Boca Raton, Florida.
- Boesch, D. F. 1977. Application of Numerical Classification in Ecological Investigations of Water Pollution. Special Scientific Report #77. Virginia Institute of Marine Science.
- Bongers, L.H., T.T. Polgar, A.J. Lippson, G.M. Krainak, L.R. Moran, A.F. Holland, and W.A. Richkus. 1975. The Impact of the Morgantown Power Plant on the Potomac Estuary: An Interpretive Summary of the 1972-1973 Investigations. Prepared by Martin Marietta Corporation, Baltimore Maryland. Sponsored by Power Plant Siting Program of the Maryland Department of Natural Resources. December.
- Boreman, J., and C.P. Goodyear. 1988. Estimates of entrainment mortality for striped bass and other fish species inhabiting the Hudson River Estuary, *in Science, Law, and Hudson River Power Plants: A Case Study of Environmental Impact Assessment*, pp. 152-160. American Fisheries Society, Bethesda, Maryland.
- Boreman, J., C.P. Goodyear, and S.W. Christensen. 1978. An Empirical Transport Model for Evaluating Entrainment of Aquatic Organisms by Power Plants. FWS/OBS-78/90. U.S. Fish and Wildlife Service, Ann Arbor, Michigan. 67 pp. November.
- Boreman, J., C.P. Goodyear, and S.W. Christensen. 1981. An empirical methodology for estimating entrainment losses at power plants sited on estuaries. *Trans. Amer. Fish. Soc.* 110:253-260.
- Boreman, J., L.W. Barnthouse, D.S. Vaughan, C.P. Goodyear, S.W. Christensen, K.D. Kumar, B.L. Kirk, and W. Van Winkle. 1982. The Impact of Entrainment and Impingement on Fish Populations in the Hudson River Estuary. Volumes I (Pub. 1790), II (Pub. 1791), and III (Pub. 1792).
- Botkin, D.B. 1975. Functional groups of organisms in model ecosystems, *in Ecosystem Analysis and Prediction. Proceedings of a Conference on Ecosystems, Alta, Utah, 1-5 July 1974* (S.A. Levin, ed.). Society for Industrial and Applied Mathematics, Philadelphia.
- Box, G.E.P., and G.M. Jenkins. 1970. *Time Series Analysis, Forecasting, and Control*. Holden Day, San Francisco.

- Box, G.E.P., and G.C. Tiao. 1975. Intervention analysis with applications to economic and environmental problems. *JASA* 70:70-79.
- Breck, J.E. 1993. Hurry up and wait: growth of young bluegills in ponds an in simulations with an individual-based model. *Trans. Amer. Fish. Soc.* 122:467-480.
- Brungs, W.A., and B.R. Jones. 1977. Temperature Criteria for Freshwater Fish: Protocol and Procedures. Environmental Research Laboratory, Duluth Office of Research and Development, U.S. Environmental Protection Agency, Duluth, Minnesota.
- Buchak, E.M., and J.E. Edinger. 1982a. Hydrothermal Simulation of Quabbin Reservoir Using Longitudinal-Vertical Hydrodynamics, Interim Report. Prepared for Wallace, Floyd Associates, Inc., Cambridge, Massachusetts.
- Buchak, E.M., and J.E. Edinger. 1982b. User's Guide for LARM2: A Longitudinal-Vertical, Time Varying Hydrodynamic Reservoir Model. Instruction Report E-82-3, U.S. Army Engineer Waterways Experiment Station, Vicksburg, Mississippi.
- Buchak, E.M. and J.E. Edinger. 1984. Generalized Longitudinal-Vertical Hydrodynamics and Transport: Development, Programming and Applications. Contract No. DACW39-84-M-1636. Prepared for U.S. Army Engineer Waterways Experiment Section, Vicksburg, Mississippi.
- Burton, W.H. 1989. Technical Review and Evaluation of Thermal Effects Studies and Cooling Water Intake Structure Demonstration of Impact for the Oyster Creek Nuclear Generating Station. Revised Final Report. Prepared for New Jersey Department of Environmental Protection, Trenton, New Jersey.
- Carlander, K.D. 1969. *Handbook of Freshwater Fishery Biology*. Volume One. The Iowa State University Press, Ames, Iowa.
- Carter, S.R. 1978. Macroinvertebrate Entrainment Study at Fort Calhoun Station, in *Fourth National Workshop on Entrainment and Impingement*, pp. 155-169 (L.D. Jensen, ed.)
- Carter, H.H., J.R. Schubel, R.E. Wilson, and P.M.J. Woodhead. 1977. A Rationale for Evaluating Thermally Induced Biological Effects due to Once-Through Cooling Systems. Marine Sciences Research Center, SUNY, Stony Brook, New York. 65 pp. September.
- Central Hudson Gas and Electric Company (CHG&E), Inc., Consolidated Edison Company of New York, New York Power Authority, and Orange and Rockland Utilities Inc. 1993. Draft Environmental Impact Statement for State Pollutant

- Discharge Elimination System Permits for Bowline Point, Indian Point 2 and 3, and Roseton Steam Electric Generating Stations. 2 volumes. June.
- Chesapeake Bay Research and Monitoring Division. 1995. A Pilot Study to Evaluate Biological, Physical, Chemical, and Land-Use Characteristics in Maryland Coastal Plain Streams. Maryland Agricultural Experiment Station CBRM-AD-95-9.
- Christensen, S.W. and T.L. Englert. 1988. Historical development of entrainment models for Hudson River striped bass, *in Science, Law, and Hudson River Power Plants*, pp. 133-142. American Fisheries Society, Bethesda, Maryland.
- Christensen, S.W. and C.P. Goodyear. 1988. Testing the validity of stock-recruitment curve fits, *in Science, Law, and Hudson River Power Plants: A Case Study in Environmental Impact Assessment*, pp. 219-231. American Fisheries Society, Bethesda, Maryland.
- Christensen, S.W., D.L. DeAngelis, and A.G. Clark. 1977. Development of a Stock-Progeny Model for Assessing Power Plant Effects on Fish Populations, *in Proceedings of the Conference on Assessing the Effect of Power-Plant-Induced Mortality on Fish Populations* (W. Van Winkle, ed.). Pergamon Press, New York.
- Christensen, S.W., D.S. Vaughan, W. Van Winkle, L.W. Barnthouse, D.L. DeAngelis, K.D. Kumar, and R.M. Yoshiyama. 1982a. Methods to Assess Impacts on Hudson River Striped Bass: Final Report. Prepared for Dr. P. Hayes, Project Representative, Office of Nuclear Regulatory Research, USNRC Under Interagency Agreement No. DOE 40-550-75. Prepared by the Oak Ridge National Laboratory.
- Christensen, S.W., C.P. Goodyear, and B.L. Kirk. 1982b. The Impact of Entrainment and Impingement on Fish Populations in the Hudson River Estuary. Volume III: An Analysis of the Validity of the Utilities' Stock-Recruitment Curve-Fitting Exercise and "Prior Estimation of Beta" Technique. Prepared for Office of Nuclear Regulatory Research, USNRC Under Interagency Agreement No. DOE 40-550-75. Prepared by Oak Ridge National Laboratory.
- Chutter, F.M. 1972. A reappraisal of Needham and Usinger's data on the variability of a stream fauna when sampled with a Surber sampler. *Limnology and Oceanography* 17A:138-141.
- Clark, M.E., and K.A. Rose. 1997. An individual-based modeling analysis of management strategies for enhancing brook char populations in southern Appalachian streams. *N. Amer. J. Fish. Manage.* 17:54-76.



- Clarke, K.R., and R.H. Green. 1988. Statistical design and analysis for a 'biological effects' study. *Mar. Ecol.-Prog. Ser.* 46:213-226.
- Cleveland, W. S. 1993. *Visualizing Data*. AT&T Bell Laboratories. Hobart Press, Murray Hill, New Jersey. 360 pp.
- Coastal Environmental Services, Inc. 1991. Assessment of the Mitigative Value of Outages and Flow Reductions, Phase IV. Final Report. Volume 1. Prepared for Central Hudson Gas and Electric on Behalf of CHG&E, Consolidated Edison Company of New York, Inc., New York Power Authority, Niagara Mohawk Power Corporation, and Orange and Rockland.
- Cone, R.S. 1989. The need to reconsider the use of condition indices in fisheries science. *Trans. Amer. Fish. Soc.* 118:510-514.
- Conover, W. J. 1980. *Practical Nonparametric Statistics*. Second Edition. Wiley, New York.
- Coughlan, D.J., B.K. Baker, D.G. Cloutman, and W.M. Rash. 1996. Application and modification of the fish health assessment index used for largemouth bass in the Catawba River North Carolina-South Carolina, *in Multidimensional Approaches to Reservoirs Fisheries Management*. AFS Symposium #16, Miranda and DeVries, Eds.
- Coutant, C.C. 1972. Biological aspects of thermal pollution. II. Scientific basis for water temperature standards at power plants. *CRC Critical Rev. in Environ. Cont.* 3(1):1-24.
- Coutant, C.C. 1992. Regulation of Thermal Discharges: Maturing Perspectives After Two Decades of Field Studies Under Section 316(a). Historical Perspective on the Regulation of Thermal Discharges. 22 pp.
- Cowan, J.H., K.A. Rose, E.S. Rutherford, and E.D. Houde. 1993. Individual-based model of young-of-the-year striped bass population dynamics. II. Factors affecting recruitment in the Potomac River, Maryland. *Trans. Amer. Fish. Soc.* 122:439-458.
- Cox, D.R., and D.V. Hinkley. 1974. *Theoretical Statistics*. Chapman Hall, New York.
- Cressie, N.A.C. 1993. *Statistics for Spatial Data*. John Wiley and Sons, Inc., New York. 900 pp.
- Crowder, L.W., J.A. Rice, T.J. Miller, and E.A. Marschall. 1992. Empirical and theoretical approaches to size-based interactions and recruitment variability in

- fishes, *in* *Individual-Based Models and Approaches in Ecology* (D.L. DeAngelis and L.J. Gross, eds.), pp. 237-255. Chapman and Hall, New York.
- Dale, V.H., and W. Van Winkle. 1998. Models provide understanding, not belief. *Bull. Ecol. Soc. Amer.* 79(2):169-170. April.
- Daniels, R.E., and J.D. Allan. 1981. Life table evaluation of chronic exposure to a pesticide. *Can. J. Fish. Aquat. Sci.* 38:485-494.
- DeAngelis, D.L., and L.J. Gross, eds. 1993. *Individual-Based Models and Approaches in Ecology*. Chapman and Hall, New York.
- DeAngelis, D.L. and K.A. Rose. 1992. Which Individual-Based Approach is Most Appropriate for a Given Problem?, *in* *Individual-Based Models and Approaches in Ecology: Populations, Communities, and Ecosystems* (D.L. DeAngelis and L.J. Gross, eds.), pp. 67-87. Chapman and Hall, New York.
- DeAngelis, D.L., W.M. Post, and G. Sugihara, eds. 1982. *Current Trends in Food Web Theory: Report on a Food Web Workshop*. ORNL5983. Oak Ridge National Laboratory, Oak Ridge, Tennessee.
- DeAngelis, D.L., P.J. Mulholland, J.W. Elwood, A.V. Palumbo, and A.D. Steinman. 1990. Biogeochemical cycling constraints on stream ecosystem recovery, *in* *Proceedings on a Symposium on the Recovery of Lotic Communities and Ecosystems Following Disturbance: Theory and Application*. *Environ. Manage.* 14:5:685-698.
- Delmarva Power. 1978. Impact of the Cooling Water Intake at the Indian River Power Plant: A Section 316(b) Evaluation. Volume 2 Text. NPDES Permit No. DE 0000078. Prepared by Ecological Analysts, Inc., Towson, Maryland.
- Delmarva Power and Light Company. 1982. Vienna Power Station. Prediction of Aquatic Impacts of the Proposed Cooling Water Intake: Section 316(b) Demonstration. Wilmington, Delaware.
- Delmarva Power and Light Company. 1993. Dorchester Power Plant Phase II Environmental Assessment. Certificate of Public Convenience and Necessity. Submitted by Delmarva Power and Light Company Before the Maryland Public Services Commission.
- De Shon, J.E. 1995. Development and application of the invertebrate community index (ICI), *in* *Biological Assessment and Criteria. Tools for Water Resource Planning and Decision Making* (W.S. Davis and T.P. Simon, eds.). Lewis Publishers, Boca Raton, Florida.

- Dew, C.B. 1981. Impact Perspective Based on Reproduction Value, *in Issues Associated With Impact Assessment: Proceedings of the Fifth National Workshop on Entrainment and Impingement* (L.D. Jensen, ed.), California, 5-7 May 1980. EA Engineering, Science, and Technology, Inc. and EPRI.
- Dickson, K. L., W. T. Waller, J. H. Kennedy, and L. P. Ammann. 1992. Assessing the relationship between ambient toxicity and instream biological response. *Environ. Toxicol. Chem.* 11:307-1322.
- Dimou, N.K., and E.E. Adams. 1989. Application of a 2-D Particle Tracking Model to Simulate Entrainment of Winter Flounder Larvae at the Millstone Nuclear Power Station. Energy Laboratory Report No. MIT-EL 89-002. November.
- Dong, Q., and D.L. DeAngelis. 1998. Consequences of cannibalism and competition for food in a smallmouth bass population: an individual-based modeling study. *Trans. Amer. Fish. Soc.* 127:174-191.
- Draper, N.R., and H. Smith 1981. *Applied Regression Analysis*. Second Edition. John Wiley and Sons, Inc. New York. 709 pp.
- EA Engineering, Science, and Technology (EA). 1978a. Hudson River Thermal Effects Studies for Representative Species-Final Report. Prepared for Central Hudson Gas and Electric Corporation, Consolidated Edison Company of New York, Inc., and Orange and Rockland Utilities, Inc.
- EA. 1978b. Thermal Effects Literature Review for Hudson River Representative Important Species. Prepared for Central Hudson Gas and Electric Corporation, Consolidated Edison Company of New York, Inc., and Orange and Rockland Utilities, Inc.
- EA. 1978c. Impact of the Cooling Water Intake at the Indian River Power Plant: A Section 316(b) Evaluation. Volume 1 Text. NPDES Permit No. DE 0000078. Prepared for Delmarva Power and Light Company. 2 volumes.
- EA. 1979a. A Holistic Assessment of the Impact of the Operation of the D.E. Karn and J.C. Weadock Plants on the Aquatic Resources of Saginaw Bay/Lake Huron. Prepared for Consumers Power Company, Jackson, Michigan.
- EA. 1979b. Assessment of Thermal Discharge Effects of the Karn and Weadock Plants on Representative Important Fish Species in Saginaw Bay/Lake Huron. Prepared for Consumers Power Company, Jackson, Michigan.

---

*References*

- EA. 1979c. Elrama Power Station Thermal Effects Study Final Report. Prepared for Duquesne Light Company, Pittsburgh, PA. Prepared by Ecological Analysts, Inc., Towson, Maryland (now EA Engineering, Science and Technology, Inc.).
- EA. 1987. Milton R. Young Station, Nelson Lake, North Dakota, 1986 Aquatic Ecology Study. Prepared for Minnkota Power Cooperative, Grand Forks, North Dakota. Prepared by EA Engineering, Science, and Technology, Lincoln, Nebraska.
- EA. 1988a. Bergen Generating Station Units 1 and 2 Supplemental 316(b) Demonstration. Prepared for Public Service Electric and Gas Company, Newark, New Jersey.
- EA. 1988b. Hudson Generating Station Units 1 and 2 Supplemental 316(b) Demonstration. Prepared for Public Service Electric and Gas Company, Newark, New Jersey.
- EA. 1988c. Kearny Generating Station Units 7 and 8 Supplemental 316(b) Demonstration. Prepared for Public Service Electric and Gas Company, Newark, New Jersey.
- EA. 1989a. Linden Generating Station Units 1 and 2 Supplemental 316(b) Report. Prepared for Public Service Electric and Gas Company, Newark, New Jersey.
- EA. 1989b. Sewaren Generating Station Supplemental 316(b) Report. Prepared for Public Service Electric and Gas Company, Newark, New Jersey.
- EA. 1992. Technical Review and Permitting of Thermal Discharge and Water Intake Structures for the Edge Moor Power Plant. Prepared for Delmarva Power and Light Company, Newark, Delaware.
- EA. 1995. Bayway Refinery Impingement and Entrainment Study for 316(b) of the Clean Water Act. Prepared for Bayway Refining Company, Linden, New Jersey.
- EA. 1996a. Assessment of Potential Entrainment and Impingement Losses During the Emergency Operation at the Hudson River Pumping Station at Chelsea. Prepared for New York City Department of Environmental Protection, Corona, New York. Revised Final Draft.
- EA. 1996b. 1995 Upper Illinois Waterway Fisheries Investigation RM 270.2 - 323.2. Prepared for Commonwealth Edison Company, Chicago, Illinois. Prepared by EA Engineering, Science, and Technology, Deerfield, Illinois.
- EA. 1997a. Final Encina Power Plant Supplemental 316(b) Assessment Report. Prepared for San Diego Gas and Electric. July.

- EA 1997b. Fish Community Assessment Conducted in Pool 3 of the Monongahela River near the Mitchell Power Station, 1997. Prepared for Allegheny Power Station, by EA Engineering, Science, and Technology, Deerfield, Illinois.
- Eaton, J.G., J.H. McCormick, B.E. Goodno, D.G. O'Brien, H.G. Stefany, M. Hondzo, and R.M. Scheller. 1995. A field information-based system for estimating fish temperature tolerances. *Fisheries* 20(4):10-18.
- Edinger, J.E., and E.M. Buchak. 1975. A Hydrodynamic, Two-Dimensional Reservoir Model: The Computational Basis. Prepared for U.S. Army Engineer Division, Ohio River, Cincinnati, Ohio.
- Edinger, J.E., and E.M. Buchak. 1978. Reservoir Longitudinal and Vertical Implicit Hydrodynamics, Environmental Effects of Hydraulic Engineering Works, Proceedings of an International Symposium. Knoxville, Tennessee.
- Edwards, D., and B. C. Coull. 1987. Autoregressive trend analysis: an example using long-term ecological data. *Oikos* 50:95-102.
- Efron, B. 1982. *The Jackknife, the Bootstrap, and Other Resampling Plans*. Society for Industrial and Applied Mathematics, Philadelphia. 92 pp.
- Electric Power Research Institute (EPRI). 1996. EPRI's CompMech Suite of Modeling Tools for Population-Level Impact Assessment. Technical Brief, Electric Power Research Institute, Palo Alto, California.
- EPRI. 1998. Using RAMAS Methods to Solve Ecological Problems Facing Utilities. Prepared for EPRI by Applied Biomathematics, Setauket, New York. Electric Power Research Institute, Palo Alto, California. TR-111387.
- Englert, T.L., and J. Boreman. 1988. Historical review of entrainment impact estimates and the factors influencing them, *in Science, Law, and Hudson River Power Plants: A Case Study in Environmental Impact Assessment*, pp. 143-151. American Fisheries Society, Bethesda, Maryland.
- Eraslan, A.H., R.D. Sharp, and W. Van Winkle. 1982. Users Manual for STRIPE: A Computer Code for Simulating Striped Bass Young-of-the-Year Population in the Hudson River. ORNL/NURI G/TM-423. Oak Ridge National Laboratory, Oak Ridge, Tennessee.
- Fausch, K.D., J.R. Karr, and P.R. Yant. 1984. Regional application of an index of biotic integrity based on stream-fish communities. *Trans. Amer. Fish. Soc.* 113:39-55.

- Fausch, K.D., J. Lyons, J.R. Karr, and P.L. Angermeier. 1990. Fish communities as indicators of environmental degradation, *in* *Biological Indicators of Stress in Fish*. American Fisheries Society Special Symposium Publication No. 8. Bethesda, Maryland.
- Ferson, S., R. Akcakaya, L. Ginzburg, and M. Krause. 1991. Use of RAMAS to Estimate Ecological Risk: Two Fish Species Case Studies. Prepared by Applied Biomathematics, Inc., Setauket, NY, for Electric Power Research Institute, Palo Alto, CA. EPRI Report EN-7176.
- Fleiss, J. L. 1981. *Statistical Methods for Rates and Proportions*. John Wiley and Sons, New York. 321 pp.
- Fletcher, R.I., and R. B. Deriso. 1988. Fishing in dangerous waters: remarks on a controversial appeal to spawner-recruit theory for long-term impact assessment, *in* *Science, Law, and Hudson River Power Plants: A Case Study in Environmental Impact Assessment*, pp. 232-240. American Fisheries Society, Bethesda, Maryland.
- Florida Power Corporation. 1977. Final Report Anclote Unit No. 1. Post-Operational Ecological Monitoring Program 1976. Volume III. Prepared in response to NPDES Permit No. FL0002992.
- Gabelhouse, D.W., Jr. 1984. A length-categorization system to assess fish stocks. *N. Amer. J. Fish. Manage.* 4(3):273-285.
- Gammon, J.R. 1976. The Fish Population of the Middle 340 km of the Wabash River. Purdue University Water Resources Research Center, Lafayette, Indiana. Technical Report 86.
- Gammon, J.R. 1977. Measurement of Entrainment and Predictions of Impact on the Wabash and Ohio Rivers, *in* *Third National Workshop on Entrainment & Impingement. Section 316(b) - Research and Compliance* (L.D. Jensen, ed.) The Communications Division of Ecological Analysts, Inc., Melville.
- Gammon, J.R. 1980. The Use of community parameters derived from electrofishing catches of river fish as indicators of environmental quality of Wabash River, *in* *Ecological Assessments of Effluent Impacts on Communities of Indigenous Aquatic Organisms* (J.M. Bates and C.I. Weber, eds.). ASTM STP 703.
- Gammon, J.R., A. Spacie, J.L. Hamelink, and R.L. Kaesler. 1981. Role of electrofishing in assessing environmental quality of the Wabash River, *in* *Ecological Assessments of Effluent Impacts on Communities of Indigenous Aquatic Organisms* (J.M. Bates and C.I. Weber, eds.), pp. 307-324. STP 730. American Society for Testing and Materials, Philadelphia.

- Gibbons, J.D. 1971. *Nonparametric Statistical Inference*. McGraw-Hill, New York.
- Gilbert, R.O. 1987. *Statistical Methods for Environmental Pollution Monitoring*. Van Nostrand Reinhold, New York. 320 pp.
- Goede, R.W. 1988. Fish Health/Condition Assessment Procedures. Utah Division of Wildlife Resources and Fisheries Publication, Experiment Station, Logan, Utah.
- Goede, R.W. 1992. Fish Health/Condition Assessment Procedures. Part 1. Utah Division of Wildlife Resources, Fisheries Experiment Station, Logan, Utah. 30 pp.
- Goede, R.W., and B.A. Barton. 1990. Organismic indices and an autopsy-based assessment as indicators of health and condition of fish, *in* *Biological Indicators of Stress in Fish* (S.M. Adams, ed.), pp. 93-108. AFS Symposium 8, AFS, Bethesda, Maryland.
- Goodyear, C.P. 1977. Assessing the Impact of Power Plant Mortality on the Compensatory Reserve of Fish Populations, *in* *Proceedings of the Conference on Assessing the Effect of Power-Plant-Induced Mortality on Fish Populations* (W. VanWinkle, ed.). Pergamon Press, New York.
- Goodyear, C.P. 1978. Entrainment Impact Estimates Using the Equivalent Adult Approach. Report No. FWS/OBS-78/65. U.S. Fish and Wildlife Service, Washington, D.C.
- Goodyear, C.P., and S.W. Christensen. 1984. Bias-elimination in fish population models with stochastic variation in survival of the young. *Trans. Amer. Fish. Soc.* 113:627-632.
- Govindarajulu, Z. 1988. *Statistical Techniques in Bioassay*. Karger, New York. 166 pp.
- Gray, J.S. 1979. Pollution-induced changes in populations. *Phil. Trans. R. Soc. Lond. B.* 286:545-561.
- Gray, J.S., K.R. Clarke, R.M. Warwick, and G. Hobbs. 1990. Detection of initial effects of pollution on marine benthos: an example from the Ekofisk and Eldfisk oilfields, North Sea. *Mar. Ecol. Prog. Ser.* 66:285-299.
- Gray, C. A., N. M. Otway, F. A. Laurenson, A. G. Miskiewicz, and R. L. Pethebridge. 1992. Distribution and abundance of marine fish larvae in relation to effluent plumes from sewage outfalls and depth of water. *Marine Biology* 113:549-559.

- Green, R.H. 1979. *Sampling Design and Statistical Methods for Environmental Biologists*. John Wiley and Sons. 257 pp.
- Green, R. H. 1993. Application of repeated measures designs in environmental impact and monitoring studies. *Australian Journal of Ecology* 18:81-98.
- Gross, L.J., K.A. Rose, E. Rykiel, W. Van Winkle, and E.E. Werner. 1992. Individual-based modeling: Summary of a workshop, *in Individual-Based Models and Approaches in Ecology*, pp. 511-522. Chapman and Hall, New York.
- Gulland, J.A. 1974. *The Management of Marine Fisheries*. Scientechica LTD, released through University of Washington Press, Bristol.
- Gulland, J.A. 1983. *Fish Stock Assessment: A Manual of Basic Methods*. John Wiley and Sons, Chichester/New York.
- Gulland, J.A. 1989. Fish populations and their management. *J. Fish. Biol.* 35(Supplement):1-9.
- Gunderson, D.R. 1993. *Survey of Fisheries Resources*. John Wiley and Sons Publishers. 248 pp.
- Guy, C.S., and D.W. Willis. 1995. Population characteristics of black crappies in South Dakota waters: a case for ecosystem-specific management. *N. Amer. J. Fish. Manage.* 15(4):754-765.
- Guy, C.S., D.W. Willis, and R.D. Schultz. 1996. Comparison of catch per unit effort and size structure of white crappies collected with trap nets and gill nets. *N. Amer. J. Fish. Manage.* 16:947-951.
- Hall, C.A.S., and J.W. Day, eds. 1977. *Ecosystem Modeling in Theory and Practice: An Introduction with Case Histories*. John Wiley and Sons, New York.
- Hansen M.J., D. Boisclair, S.B. Brandt, S.W. Hewett, J.F. Kitchell, M.C. Lucas, J.J. Ney. 1993. Applications of bioenergetics models to fish ecology and management: Where do we go from here? *Trans Amer. Fish. Soc.* 122:1019-1030.
- Harris, R. J. 1975. *A Primer of Multivariate Statistics*. Academic Press. 332 pp.
- Haven, K.F., and T.C. Ginn. 1978. A mathematical model of the interactions of an aquatic ecosystem and a thermal power station cooling system, *in Fourth National Workshop on Entrainment and Impingement* (L.D. Jensen, ed.).



- Hickman, G.D. 1997. Sport Fishing Index--1996. TVA Aquatic Biology Lab, Norris, Tennessee. 11 pp.
- Hickman, G.D., and T.A. McDonough. 1996. Assessing the reservoir fish assemblage index: a potential measure of reservoir quality. AFS Symposium 16. AFS, Bethesda, Maryland. pp. 85-97.
- Hilborn, R., and A. Punt. 1993. The Effects of Power Plant Mortality on Hudson River Striped Bass. Appendix VI-4A of Draft Environmental Impact Statement for State Pollutant Discharge Elimination System Permits for Bowline Point, Indian Point 2 and 3, and Roseton Steam Electric Generating Stations. Prepared for Central Hudson Gas and Electric Corporation; Consolidated Edison Company of New York, Inc.; New York Power Authority; and Orange and Rockland Utilities, Inc.
- Hilborn, R., and C.J. Walters. 1992. *Quantitative Fisheries Stock Assessment: Choice, Dynamics, and Uncertainty*. Chapman and Hall Publishers. 570 pp.
- Hilborn, R., M. Adkison, and A. Punt. 1993a. An Analysis of the Impacts of Power Plant Entrainment and Impingement on White Perch in the Hudson River. Appendix VI-4B of Draft Environmental Impact Statement for State Pollutant Discharge Elimination System Permits for Bowline Point, Indian Point 2 and 3, and Roseton Steam Electric Generating Stations. Prepared for Central Hudson Gas and Electric Corporation, Consolidated Edison Company of New York, Inc., New York Power Authority, and Orange and Rockland Utilities, Inc.
- Hilborn, R., J. Ianielli, and A. Punt. 1993b. The Effect of Power Plant Mortality on Hudson River Tomcod. Appendix VI-4C of Draft Environmental Impact Statement for State Pollutant Discharge Elimination System Permits for Bowline Point, Indian Point 2 and 3, and Roseton Steam Electric Generating Stations. Prepared for Central Hudson Gas and Electric Corporation., Consolidated Edison Company of New York, Inc., New York Power Authority, and Orange and Rockland Utilities, Inc.
- Hilborn, R., M. Pascual, and A. Punt. 1993c. The Effect of Power Plant Mortality on Hudson River American Shad. Appendix VI-4D of Draft Environmental Impact Statement for State Pollutant Discharge Elimination System Permits for Bowline Point, Indian Point 2 and 3, and Roseton Steam Electric Generating Stations. Prepared for Central Hudson Gas and Electric Corporation, Consolidated Edison Company of New York, Inc., New York Power Authority, and Orange and Rockland Utilities, Inc.
- Hilborn, R., M. Pascual, and A. Punt. 1993d. The Effects of Power Plant Mortality on Hudson River Bay Anchovy. Appendix VI-4E of Draft Environmental Impact

- Statement for State Pollutant Discharge Elimination System Permits for Bowline Point, Indian Point 2 and 3, and Roseton Steam Electric Generating Stations. Prepared for Central Hudson Gas and Electric Corporation, Consolidated Edison Company of New York, Inc., New York Power Authority, and Orange and Rockland Utilities, Inc.
- Hilsenhoff, W.L. 1977. Use of Arthropods to Evaluate Water Quality of Streams. Technical Bulletin 100-16. Department of Natural Resources, Lansing, Michigan.
- Hilsenhoff, W.L. 1987. An improved biotic index of organic stream pollution. *The Great Lakes Entomologist* 1, 31-39.
- Holland, A.F., A.T. Shaughnessy, and M.H. Heigel. 1987. Long-term variation in mesohaline Chesapeake Bay macrobenthos: spatial and temporal patterns. *Estuaries* 10:(3):227-245.
- Holling, C.S. 1996. Editorial: Two cultures of ecology. *Conservation Ecology*.
- Horst, T.J. 1975. The assessment of impact due to entrainment of ichthyoplankton, in *Fisheries and Energy Production: A Symposium* (S.B. Saila, ed.), pp. 107-118. D.C. Heath, Lexington, Massachusetts. Salem - DPL.
- Horst, T.J. 1977. Effects of power station mortality on fish population stability in relationship to life history strategy, in *Assessing the Effects of Power-Plant Induced Mortality on Fish Populations* (W. Van Winkle, ed.), pp. 297-310. Proceedings of a conference in Gatlinburg, Tennessee, May 1977. Pergamon Press, New York.
- Hudson River Policy Committee (HRPC). 1968. Hudson River fisheries investigations (1965-1968). Report to Consolidated Edison Company of New York, in *Historical Review of Entrainment Impact Estimates and the Factors Influencing Them*. American Fisheries Society Monograph 4:143-151.
- Huff, D. 1954. *How to Lie With Statistics*. W. W. Norton and Company, New York. 142 pp.
- Hurlbert, S. H. 1984. Pseudoreplication and the design of ecological field experiments. *Ecological Monographs* 54(2):187-211.
- Huston, M., D. DeAngelis, and W. Post. 1988. New computer models unify ecological theory. *BioScience* 38:682-691.
- Illinois Natural History Survey (INHS). 1979a. Evaluation of a Cooling Lake Fishery. Volume 2: Lake Sangchris Ecosystem Modeling. EPRI EA-1148, Project 573, Final Report, November.

- INHS. 1979b. Evaluation of a Cooling Lake Fishery. Volume 3: Fish Population Studies. EPRI EA-1148, Project 573, Final Report, December.
- Intersea Research Corporation. 1981. Haynes Generating Station Cooling Water Intake Study 316(b) Demonstration Program 1978-1979. Prepared for Los Angeles Department of Water and Power, Los Angeles, California. San Diego, California.
- Jager, H.I., D.L. DeAngelis, M.J. Sale, W. Van Winkle, D.D. Schmoyer, M.J. Sabo, D.J. Orth, and J.A. Lukas. 1993. An individual-based model for smallmouth bass reproduction and young-of-year dynamics in streams. *Rivers* 4:91-113.
- Jenkins, R.M. 1979. Predator-prey relations in reservoirs, *in Predator-Prey Systems in Fisheries Management* (R.H. Stroud and H. Clepper, eds.), pp. 123-134. Sport Fishing Institute, Washington, D.C.
- Jenkins, R.M., and D.I. Morais. 1978. Prey-Predator Relations in the Predator-Stocking-Evaluation Reservoirs. *Proc. Ann. Conf. Southeastern Assoc. Game and Fish Commissioners* 30:141-157.
- Jennings, M.J., J. Lyons, E.E. Emmons, G.R. Hatzenbeler, M. Bozek, T.D. Simonson, T.D. Beard, Jr., and D. Fago. 1999. Toward the development of an index of biotic integrity for inland lakes in Wisconsin, *in Assessing the Sustainability and Biological Integrity of Water Resources Using Fish Communities* (T.P. Simon, ed.), pp. 541-562. CRC Press.
- Jensen, L.D., ed. 1974. *Proceedings of the Second Workshop on Entrainment and Intake Screening: Cooling Water Studies for Electric Power Research Institute*. Ecological Analysts, Inc. (now EA Engineering, Science, and Technology, Inc.).
- Jensen, L.D., ed. 1976. *Third National Workshop on Entrainment & Impingement. Section 316(b) - Research and Compliance*. The Communications Division of Ecological Analysts, Inc., Melville, NY (now EA Engineering, Science, and Technology, Inc.).
- Jensen, L.D., ed. 1978. *Fourth National Workshop on Entrainment and Impingement. Workshop Proceedings*. Ecological Analysts, Inc. (now EA Engineering, Science, and Technology, Inc.).
- Jensen, L.D., ed. 1980. *Issues Associated With Impact Assessment: Proceedings of the Fifth National Workshop on Entrainment and Impingement*. Ecological Analysts, Inc. (now EA Engineering, Science, and Technology, Inc.).

- Jensen, L.D., ed. 1981. *Issues Associated With Impact Assessment: Proceedings of the Fifth National Workshop on Entrainment and Impingement*. California, 5-7 May 1980, EA Engineering, Science, and Technology, Inc. and EPRI.
- Jensen, A.L., R.H. Reider, and W.P. Kovalak. 1988. Estimation of Production Foregone. *N. Amer. J. Fish. Manage.* 8:191-198.
- Jersey Central Power and Light Company (JCP&L). 1978. Ecological Studies for the Oyster Creek Nuclear Generating Station. Effects of Thermal Discharges on Plankton, Macroinvertebrates, and Fish. Addendum to Appendix C1. September.
- Johnson, D.L., and R.O. Anderson. 1974. Evaluation of a 12-inch length limit on largemouth bass in Philips Lake, 1966-1973, *in* Symposium on Largemouth Bass Overharvest and Management in Small Impoundments (J.L. Funk, ed.), pp. 106-116. Special Publication 3, North Central Division, American Fisheries Society, Bethesda, Maryland.
- Johnson, R.A., and D. W. Wichern. 1982. *Applied Multivariate Analysis*. Prentice Hall, Inc., Englewood Cliffs, New Jersey. 594 pp.
- Jude, D.J., P.J. Mansfield, P.J. Schneeberger, and J.A. Wojcik. 1987. Compensatory Mechanisms in Fish Populations: Literature Reviews. Volume 2: Compensation in Fish Populations Subject to Catastrophic Impact. EPRI EA-5200, Volume 2, Research Project 1633-6. Final Report. May.
- Kaluzny, S.P., K.A. Rose, P.J. Sullivan, and G.L. Swartzman. 1983. Evaluation of Ecosystem Models in Power Plant Impact Assessment: A Case Study Using Lake Ontario. Description of alternative process equations and documentation of parameter values. NUREG/CR3308. U.S. Nuclear Regulatory Commission; Washington, D.C. 58 pp.
- Karas, P., E. Neuman, and O. Sandstrom. 1991. Effect of a pulp mill effluent on the population dynamics of Perch, *Perca fluviatilis*. *Can. J. Fish. Aquat. Sci.* 48:28-34.
- Karr, J.R. 1981. Assessment of biotic integrity using fish communities. *Fisheries* 6(6):21-27.
- Karr, J.R. 1991. Biological integrity: a long-neglected aspect of water resource management. *Ecol. Application* 1:66-84.
- Karr, J.R., and D.R. Dudley. 1981. Ecological perspective on water quality goals. *Environ. Manage.* 5:55-68.

- Karr, J.R., K.D. Fausch, P.L. Angermeier, P.R. Yant, and I.J. Schlosser. 1986. Assessing Biological Integrity in Running Waters: A Method and Its Rationale. Illinois Natural History Survey Special Publication 5. September.
- Kemp, W.M. 1981. Energy analysis and ecological impact assessment: A case study of a coastal power plant in Florida, *in* *Issues Associated With Impact Assessment: Proceedings of the Fifth National Workshop on Entrainment and Impingement* (L.D. Jensen, ed.), pp. 225-241. California, 5-7 May 1980. EA Engineering, Science, and Technology, Inc. and EPRI.
- Kemp, W.M., Smith, W.H.B., McKellar, H.N., Lehman, M.E., Homer, M., Young, D.L., Odum, H.T. 1977. Energy Cost-Benefit Analysis Applied to Power Plants Near Crystal River, Florida, *in* *Ecosystem Modeling in Theory and Practice: An Introduction with Case Histories* (C.A.S. Hall and J.W. Day, eds.). John Wiley and Sons, New York
- Kendall, M. S. 1976. *Time-Series*. 2nd Edition. Charles Griffin and Company, Ltd. 197 pp.
- Kerans, B.L., and J.R. Karr. 1994. A benthic index of biological integrity (B-IBI) for rivers of the Tennessee Valley. *Ecological Applications* 4:768-785.
- King, R.G. 1978. Entrainment of Missouri River fish larvae through Fort Calhoun station, *in* *Fourth National Workshop on Entrainment and Impingement* (L.D. Jensen, ed.), pp. 45-56.
- Kleinbaum, D.G., and L. L. Kupper. 1978. *Applied Regression Analysis and Other Multivariable Methods*. Duxbury Press. 556 pp.
- Kumar, K.D., and S.M. Adams. 1977. Estimation of age structure of fish populations from length-frequency data, *in* *Proceedings of the Conference on Assessing the Effects of Power-Plant-Induced Mortality on Fish Populations* (W. Van Winkle, ed.), pp. 256-281. Pergamon Press, New York.
- Laine, P.A., G.H. Lauff, and R. Levins. 1975. The feasibility of using a holistic approach in ecosystem analysis, *in* *Ecosystem Analysis and Prediction. Proceedings of a Conference on Ecosystems. Alta, Utah, 1-5 July 1974* (S.A. Levin, ed.). Society for Industrial and Applied Mathematics, Philadelphia.
- Larsen, D.P., J. M. Omernik, R.M. Hughes, C.M. Rohm, T.R. Whittier, A.J. Kenney, A.L. Gallant, and D.R. Dudley. 1986. Correspondence between spatial patterns in fish assemblages in Ohio streams and aquatic ecoregions. *Environ. Manage.* 10(6):815-828.

- Lawler, J.P. 1988. Some considerations in applying stock-recruitment models to multiple-age spawning populations, *in Science, Law, and Hudson River Power Plants: A Case Study in Environmental Impact Assessment*, pp. 204-218. American Fisheries Society, Bethesda, Maryland.
- Lawler, J.P., and T.L. Englert. 1978. Models useful for the estimation of equilibrium population reduction due to power plant croppings, *in Fourth National Workshop on Entrainment and Impingement* (L.D. Jensen, ed.), pp. 155-169.
- Lawler, J.P., R.A. Norris, G. Goldwyn, Abod, K.A., and Englert T.L. 1974. Hudson River striped bass life cycle model, *in Proceedings of the Second Workshop on Entrainment and Intake Screening: Cooling Water Studies for Electric Power Research Institute* (L.D. Jensen, ed.).
- Lawler, J.P., W.T. Hogarth, B.J. Copeland, M.P. Weinstein, R.G. Hodson, and H.Y. Chen. 1981. Techniques for assessing the impact of entrainment and impingement as applied to the Brunswick Steam Electric Plant, *in Issues Associated With Impact Assessment: Proceedings of the Fifth National Workshop on Entrainment and Impingement* (L.D. Jensen, ed.). California, 5-7 May 1980. EA Engineering, Science, and Technology, Inc. and EPRI.
- Lawler, J.P., M.P. Weinstein, H.Y. Chen, and T.L. Englert. 1988. Modeling of physical and behavioral mechanisms influencing recruitment of spot and Atlantic croaker to the Cape Fear estuary. *Amer. Fish. Soc. Symp.* 3:115-131.
- Lawler, Matusky and Skelly Engineers (LMS). 1975. Report on Development of a Real-Time, Two-Dimensional Model of the Hudson River Striped Bass Population. Prepared for Consolidated Edison Company of New York, Inc.
- LMS. 1979a. Ecosystem Effects of Phytoplankton and Zooplankton Entrainment. EPRI EA-1038, Project 876, Interim Report. April.
- LMS. 1979b. Methodology for Assessing Population and Ecosystem Level Effects Related to Intake of Cooling Waters. EPRI EA-1238, Project 876. November.
- LMS. 1980a. Methodology for Assessment Population and Ecosystem Level Effects Related to Intake of Cooling Waters. Volume 1: Handbook of Methods Population Level Technique. EPRI EA-1402, Project 876. Final Report. June.
- LMS. 1980b. Methodology for Assessment Population and Ecosystem Level Effects Related to Intake of Cooling Waters. Volume 2: Handbook of Methods Community Analysis Techniques.

- Le Cren, E.D. 1951. The length-weight relationship and seasonal cycle in gonad weight and condition in the perch (*Perca fluviatilis*). *J. Anim. Ecol.* 20:201-219.
- Leggett, W.C. 1976. The American shad (*Alosa sapidissima*), with special reference to its migration and population dynamics in the Connecticut River, in *The Connecticut River Ecological Study, The Impact of a Nuclear Power Plant* (D. Merriman and L.M. Thorpe, eds.).
- Leggett, W.C. 1977. Density dependence, density independence, and recruitment in the American shad (*Alosa sapidissima*) population of the Connecticut River, in *Proceedings of the Conference on Assessing the Effect of Power-Plant-Induced Mortality on Fish Populations* (W. VanWinkle, ed.). Pergamon Press, New York.
- Leggett, W.C. 1981. Population-level vs. community/ecosystem level approaches to impact assessment. in *Issues Associated With Impact Assessment: Proceedings of the Fifth National Workshop on Entrainment and Impingement* (L.D. Jensen, ed.), pp. 75-78. California, 5-7 May 1980. EA Engineering, Science, and Technology, Inc. and EPRI.
- Leonard, P.M., and D.J. Orth. 1986. Application and testing of an index of biotic integrity in small, coolwater streams. *Trans. Amer. Fish. Soc.* 115:401-415.
- Leslie, P.H. 1945. On the use of matrices in certain population mathematics. *Biometrika* 33: 183-212.
- Leslie, P.H. 1948. Some further notes on the use of matrices in population mathematics. *Biometrika* 35:213-245.
- Levin, S.A., ed. 1974. *Ecosystem Analysis and Prediction. Proceedings of a Conference on Ecosystems. Alta, Utah, 1-5 July 1974.* Society for Industrial and Applied Mathematics, Philadelphia.
- Logan, B.E., and C. Kleinstreuer. 1981. A dynamic computer simulation model for impact assessment of fish impingement, in *Issues Associated With Impact Assessment: Proceedings of the Fifth National Workshop on Entrainment and Impingement* (L.D. Jensen, ed.). California, 5-7 May 1980. EA Engineering, Science, and Technology, Inc. and EPRI.
- Lomnicki, A. 1988. *Population Ecology of Individuals.* Princeton University Press, Princeton, New Jersey.
- Long Island Lighting Company (LILCO). 1975a. 316(a) and (b) Demonstration for Jamesport Nuclear Power Station Units 1 and 2. Section 3.4 (Assessment of the

- Total Effects of Plant Operation on Selected Representative Important Species). Hicksville, New York.
- LILCO. 1975b. 316 (a) and (b) Demonstration for Shoreham Nuclear Power Station Unit 1. Hicksville, New York.
- Loos, J.J., and E.S. Perry. 1989. Evaluation of Forage Risk Entrainment of Chalk Point Station. Appendix A. Environmental Affairs Group, Water Quality Department, Potomac Electric Power Company. 15 March.
- Ludwig, J.A., and J. F. Reynolds. 1988. *Statistical Ecology: A Primer on Methods and Computing*. John Wiley and Sons. 337 pp.
- Luecke, C., J.A. Rice, L.B. Crowder, S.F. Yeo, and F.P. Binkowski. 1990. Recruitment mechanisms of bloater in Lake Michigan: An analysis of the predatory gauntlet. *Can. J. Fish. Aquat. Sci.* 47:524-532.
- MacBeth, A. 1977. Modeling in the context of the law, in *Ecosystem Modeling in Theory and Practice: An Introduction with Case Histories* (C.A.S. Hall and J.W. Day, eds.). John Wiley and Sons, New York.
- MacCall, A.D., K.R. Parker, R. Lethiser, and W. Jensen. 1983. Power plant impact assessment: A simple fishery production model approach. *Fish. Bull.* 81(3):613-619.
- Mapstone, B.D. 1995. Scalable decision rules for Environmental Impact Studies: effect size, Type I, and Type II errors. *Ecological Applications* 5(2):410-412.
- Marcy, B.C., Jr. 1974. Vulnerability and survival of young Connecticut River fish entrained at a nuclear power plant, in *Proceedings of the Second Workshop on Entrainment and Intake Screening: Cooling Water Studies for Electric Power Research Institute* (L.D. Jensen, ed.).
- Marcy, B.C., Jr. 1976. Fishes of the lower Connecticut River and the effects of the Connecticut Yankee Plant, in *The Connecticut River Ecological Study*, pp. 61-113. Monograph No. 1. American Fisheries Society, Bethesda, Maryland.
- Martin Marietta Corporation. 1983. Impact Assessment Report: C.P. Crane Steam Electric Station Aquatic Monitoring Program. Prepared for Maryland Department of Natural Resources. Volume I: Text; Volume II: Appendices A-G. January.
- Marwitz, T.D., and W.A. Hubert. 1997. Trends in relative weight of walleye stocks in Wyoming reservoirs. *N. Amer. J. Fish. Manage.* 17:44-53.



- McCullagh, P., and J. A. Nelder. 1989. *Generalized Linear Models*. Second Edition. Chapman and Hall, New York. 511 pp.
- McFadden, J.T. 1977. An argument supporting the reality of compensation in fish populations and a plea to let them exercise it, *in Proceedings of the Conference on Assessing the Effect of Power-Plant-Induced Mortality on Fish Populations* (W. VanWinkle, ed.). Pergamon Press, New York.
- McFadden, J.T., and J.P. Lawler. 1977. Supplement I - Influence of Indian Point Unit 2 and Other Steam Electric Generating Plants on the Hudson River Estuary, with Emphasis on Striped Bass and Other Fish Populations. Submitted to Consolidated Edison Company of New York, Inc., New York, New York. July.
- McFadden, J.T., Texas Instruments, and Lawler, Matusky, and Skelly Engineers. 1978. Influence of the Proposed Cornwall Pumped Storage Project and Steam Electric Generating Plants on the Hudson River Estuary with Emphasis on Striped Bass and Other Fish Populations, Revised. Prepared for Consolidated Edison Company of New York, Inc.
- McKellar, H.N., Jr. and W.H.B. Smith. 1981. Ecosystem-level assessments should be emphasized over population-level assessments. *in Issues Associated With Impact Assessment: Proceedings of the Fifth National Workshop on Entrainment and Impingement* (L.D. Jensen, ed.), pp. 67-74. California, 5-7 May 1980. EA Engineering, Science, and Technology, Inc. and EPRI.
- Merriman, D., and L.M. Thorpe. 1976. The Connecticut River ecological study: The impact of a nuclear power plant. *Amer. Fish. Soc. Monogr.* 1. 252 pp.
- Metz, J.A.J., and O. Diekmann, eds. 1986. *The Dynamics of Physiologically Structured Populations*. Lecture Notes in Biomathematics 68. Springer-Verlag, Berlin.
- Milliken, G.A., and D.E. Johnson. 1984. *Analysis of Messy Data. Volume 1: Designed Experiments*. Van Nostrand Reinhold, New York. 473 pp.
- Murphy, B.R., and D.W. Willis, eds. 1996. *Fisheries Techniques*. Second Edition. American Fisheries Society, Bethesda, Maryland. 732 pp.
- Murphy, B.R., D.W. Willis, and T.A. Springer. 1991. The relative weight index in fisheries management: status and needs. *Fisheries* 16(2):30-38.
- Nelson, D.A., A. Calabrese, and J.R. Macinnes. 1977. Mercury stress on juvenile bay scollops, *Argopecten irradians*, under various salinity-temperature regimes. *Mar. Biol.* 43:293-297.

- Nesbit, R.M., A. Stewart-Oaten, and W.W. Murdoch. 1990. Final Technical Report to the California Coastal Commission-Section M. Bight-wide Effects on Fish: Compensation. Prepared for Marine Review Committee of the California Coastal Commission.
- Neter, J., W. Wasserman, and M. H. Kutner. 1985. *Applied Linear Statistical Models: Regression, Analysis of Variance, and Experimental Designs*. Richard D. Irwin, Inc. 1,127 pp.
- Niemela, S., E. Pearson, T.P. Simon, R.M. Goldstein, and P.A. Bailey. 1999. Development of an index of biotic integrity for the species Depauperate Lake Agassiz Plain Eco Region, North Dakota and Minnesota, *in Assessing the Sustainability and Biological Integrity of Water Resources Using Fish Communities* (T.P. Simon, ed.), pp. 339-366. CRC Press.
- Noble, R.L. 1981. Management of forage fishes in impoundments of the southern United States. *Trans. Amer. Fish. Soc.* 110(6):738-750.
- Noreen, E.W. 1989. *Computer-Intensive Methods for Testing Hypotheses: An Introduction*. John Wiley and Sons, New York. 229 pp.
- Northeast Utilities Environmental Laboratory (NUEL). 1990. Monitoring the Marine Environment of Long Island Sound at Millstone Nuclear Power Station. Annual Report. Waterford, Connecticut.
- NUEL. 1993. Monitoring the Marine Environment of Long Island Sound at Millstone Nuclear Power Station. Annual Report 1992. Waterford, Connecticut.
- Novinger, G.D., and J.G. Dillard, eds. 1978. *New Approaches to the Management of Small Impoundments*. Special Publication 5. North Central Division, American Fisheries Society, Bethesda, Maryland.
- Oak Ridge National Laboratory and The Atomic Industrial Forum. 1979a. Chemical Effects of Power Plant Cooling Waters: An Annotated Bibliography. EPRI EA-1072, Research Project 877, ORNL/EIS-134, Interim Report. May.
- Oak Ridge National Laboratory and The Atomic Industrial Forum. 1979b. Impingement: An Annotated Bibliography. EPRI EA-1050, Project 877.
- Oak Ridge National Laboratory and The Atomic Industrial Forum. 1979c. Entrainment: An Annotated Bibliography. EPRI EA-1049, Project 877, ORNL/EIS-136. April.

- Oak Ridge National Laboratory and The Atomic Industrial Forum. 1979d. Thermal Entrainment: An Annotated Bibliography. EPRI EA-150, Project 877, ORNL/EIS-135. Interim Report. April.
- Oak Ridge Systems Ecology Group. 1975. Dynamic ecosystem models: Progress and challenges, *in* *Ecosystem Analysis and Prediction. Proceedings of a Conference on Ecosystems. Alta, Utah, 1-5 July 1974* (S.A. Levin, ed.).
- Oberdorff, T., and R.M. Hughes. 1992. Modification of an index of biotic integrity based on fish assemblages to characterize rivers of the Seine Basin, France. *Hydrobiologia* 228:117-130.
- Odum, E.P. 1971. *Fundamentals of Ecology*. 3<sup>rd</sup> Edition. Saunders, Philadelphia.
- Odum, H.T. 1974. Energy cost-benefit models for evaluating thermal plumes, *in* *Thermal Ecology* (J.W. Gibbons and R.R. Sharitz, eds.). U.S. Atomic Energy Commission, TIC, Office of Information Services, Washington, D.C.
- Ohio Environmental Protection Agency (OEPA). 1987. Biological Criteria for the Protection of Aquatic Life: Volume II. Users Manual for Biological Field Assessment of Ohio Surface Waters Section, Columbus, Ohio (and addendum dated 30 September 1989).
- OEPA. 1989. Biological criteria for the protection of aquatic life: Volume III. Standardized field and laboratory methods for assessing fish and macroinvertebrate communities. Division of Water Quality Monitoring and Assessment, Surface Water Section, Columbus, Ohio. First Update: 30 September 1989.
- Orange and Rockland Utilities, Inc. (ORU). 1978. Bowline Point Generating Station Near-Field Effects of Once-Through Cooling System on Hudson River Biota. Prepared by EA Engineering, Science, and Technology (formerly Ecological Analysts); and Lawler, Matusky and Skelly Engineers, Inc., Spring Valley, New York.
- Orlob, G.T. 1975. Present problems and future prospects of ecological modeling, *in* *Ecological Modeling in a Resource Management Framework*, pp. 283-313. Johns Hopkins Press, Baltimore.
- Pacific Gas and Electric (PG&E). 1988. Final Thermal Effects Monitoring Program (TEMP) Report. Diablo Canyon Power Plant - NPDES No. CA0003751.

- Parker, K., and E. DeMartini. 1988. Final Technical Report to the California Coastal Commission-Section D. Adult-Equivalent Loss. Prepared for Marine Review Committee of the California Coastal Commission.
- Parker, K., J.R. Bence, and J. Kastendiek. 1989. Technical Report to the California Coastal Commission. Section N. Integration of Local Depressions and Increases in Fish Stocks with Inplant Losses. Prepared by the Marine Review Committee. Study of the effects of San Onofre Nuclear Generating Station on the marine environment.
- Pearson, K. 1900. On the criterion that a given system of deviations from the probable in the case of a correlated system of variables is such that it can be reasonably supposed to have arisen from random sampling. *Philos. Mag.* 50(5):157-175.
- Pearson, T.H., and Rosenberg. 1978. Macrobenthic succession in relation to organic enrichment and pollution of the marine environment. *Oceanographer Marine Biology Annual Review* 16:229-311.
- Peilou, E.C. 1969. *An Introduction to Mathematical Ecology*. John Wiley and Sons, New York. 286 pp.
- Peterman, R.M., and M.J. Bradford. 1987. Statistical power of trends in fish abundance. *Can. J. Fish. Aquat. Sci.* 44:1879-1889.
- Pikitch, E.K., R.A. Alevras, J.M. Hillegas, Jr., and D.T. Logan. 1978. Possibilities for Assessment of the Effects of Power Plant Operation at the Ecosystem Level, in *Fourth National Workshop on Entrainment and Impingement* (L.D. Jensen, ed.), pp. 155-169.
- Platts, W.S., W.F. Megahan, and G.W. Minshall. 1983. Methods for Evaluating Stream, Riparian, and Biotic Conditions. General Technical Report INT-138. U.S. Department of Agriculture, U.S. Forest Service, Ogden, Utah.
- Polgar, T.T., Bongers, L.H., and G.M. Krainak. 1976. Assessment of power-plant effects on zooplankton in the near field, in *Thermal Ecology II* (G.W. Esch and F.W. McFarlane, eds.) Energy Research and Development Administration, Washington, D.C.
- Polgar, T.T., J.K. Summers, and M.S. Haire. 1979. Evaluation of the Effects of the Morgantown SES Cooling System on Spawning and Nursery Areas of Representative Important Species. Martin Marietta Corporation, Baltimore. October.

- Polgar, T.T., J.K. Summers, and M.S. Haire. 1981. A procedure for assessing potential power plant entrainment impact, *in* *Issues Associated With Impact Assessment: Proceedings of the Fifth National Workshop on Entrainment and Impingement* (L.D. Jensen, ed.). California, 5-7 May 1980. EA Engineering, Science, and Technology, Inc. and EPRI.
- Portner, E.M., and L.C. Kohlenstein. 1979. Prediction of Entrainment/Impingement Impact for Striped Bass Eggs and Larvae by the Proposed Vienna Unit No. 9. Report No. JHU PPSE 8-1. Applied Physics Laboratory, The Johns Hopkins University, Laurel, Maryland. Prepared for the Maryland Power Plant Siting Program.
- Primrose, N.L., W.L. Butler, and E.S. Friedman. 1991. Assessing biological integrity using EPA rapid bioassessment protocol II: the Maryland experience, *in* *Biological Criteria: Research and Regulation, Proceedings of a Symposium*, pp. 131-132. EPA-440-5-91-005. U.S. Environmental Protection Agency, Office of Water, Washington, D.C.
- Pritchard, D.W. 1960. The application of existing oceanographic knowledge to the problem of radioactive waste disposal into the sea, *in* *Disposal of Radioactive Wastes*, pp. 229-249. Volume 2. International Atomic Energy Agency, Vienna.
- Public Service Electric and Gas Company (PSE&G). 1974. Salem Nuclear Generating Station 316(a) Type II Demonstration. Newark, New Jersey. September.
- PSE&G. 1984. Salem Generating Station 316(b) Demonstration, Text. A Synthesis of Information on Natural History with Reference to Occurrence in the Delaware River and Estuary, and Involvement with the Salem Generating Station. Appendix 1 thru 13. Newark, New Jersey, May. NPDES Permit No. NJ0005622.
- PSE&G. 1985. Study Plan and Methods. Salem Generating Station 316(b) Demonstration Appendix I. 2 volumes. April.
- PSE&G. 1988a. Bergen Generating Station Units 1 and 2 Supplemental 316(a) Demonstration. Submitted to New Jersey Department of Environmental Protection. Prepared by EA Engineering, Science, and Technology.
- PSE&G. 1988b. Hudson and Kearny Generating Stations Supplemental 316(a) Demonstration. Submitted to New Jersey Department of Environmental Protection. Prepared by EA Engineering, Science, and Technology.
- PSE&G. 1989a. Sewaren Generating Station Supplemental 316(a) Demonstration. Prepared by EA Engineering, Science, and Technology, Newburgh, New York. Newark, New Jersey.

- PSE&G. 1989b. Linden Generating Station Supplemental 316(a) Demonstration. Prepared by EA Engineering, Science, and Technology, Newburgh, New York. Newark, New Jersey.
- PSE&G. 1993a. Supplement Permit Renewal Application; Salem Generating Station, NJPDES Permit No. NJ0005622. Vol I and II. PSE&G, Newark, New Jersey.
- PSE&G. 1993b. Comments on Draft NJPDES Permit No. NJ0005622. 16 September. 27 Volumes.
- PSE&G. 1994. Comments on Draft NJPDES Permit No. NJ0005622, January. 10 Volumes.
- R.G. Otto & Associates and Science Applications International Corporation. 1987. *Mechanisms of Compensatory Response of Fish Populations*. Workshop Proceedings. EPRI EA-5202, Research Project 1633. Key West, Florida. June.
- Rago, P.J. 1980. A Temporally Distributed Matrix Model for Inshore Fish Populations in Lake Michigan. M.S. Thesis. Colorado State University, Ft. Collins, Colorado.
- Rago, P.J. 1984. Production foregone: An alternative method for assessing the consequences of fish entrainment and impingement losses at power plants and water intakes. *Ecol. Modell.* 24:79-111.
- Ranasinghe, J.A., Scott, L.C., Newport, R.C., and S.B. Weisberg. 1994a. Long-Term Benthic Monitoring and Assessment Component. Level 1 Comprehensive Report. Chesapeake Bay Water Quality Monitoring Program; July 1984-December 1993. Prepared for MDE, Chesapeake Bay and Watershed Management Administration and MDNR Chesapeake Bay Research and Monitoring Division by Versar, Inc. December.
- Ranasinghe, J.A., Weisberg, S.B., Dauer, D.M., Schaffner, L.C., Diaz, R.J. and J.B. Frithsen. 1994b. Chesapeake Bay Benthic Community Restoration Goals. Prepared for U.S. EPA, Chesapeake Bay Program. March.
- Rankin, E.T. 1991. The Use of Biocriteria in the Assessment of Nonpoint and Habitat Impacts in Warmwater Streams. Division of Surface Water, Ecological Assessment Section, Ohio Environmental Protection Agency, Columbus, Ohio.
- Rao, C. R. 1973. *Linear Statistical Inference and Its Applications*. Second Edition. John Wiley and Sons, New York. 62 pp.
- Reynolds, J.B., and L.R. Babb. 1978. Structure and dynamics of largemouth bass populations, *in* *New Approaches to the Management of Small Impoundments* (G.D.

- Novinger and J.G. Dillard, eds.), pp. 50-61. Special Publication 5. North Central Division, American Fisheries Society, Bethesda, Maryland.
- Rhoads, D.G., P.L. McCall, and J.Y. Yingt. 1978. Disturbance and production on the estuarine sea floor. *Amer. Scient.* 66:577-586.
- Ricker, W.E. 1946. Production and utilization of fish populations. *Ecol. Monogr.* 16: 374-391
- Ricker, W.E. 1954. Stock and recruitment. *J. Fish. Res. Board Can.* 11(5):559-623.
- Ricker, W.E., ed. 1975. *Computation and Interpretation of Biological Statistics of Fish Populations*. Bulletin 191. Department of the Environment, Fisheries and Marine Service, Ottawa. 382 pp.
- Rogers, G.D. 1978. Entrainment of crustacean zooplankton through Fort Calhoun station, *in* *Fourth National Workshop on Entrainment and Impingement* (L.D. Jensen, ed.), pp. 155-169.
- Rogers, K.B., L.C. Bergsted, and E.P. Bergersen. 1996. Standard weight equation for mountain whitefish. *N. Amer. Jour. Fish. Manage.* 16(1):207-209.
- Rose, K.A., and J.H. Cowan, Jr. 1993. Individual-based model of young-of-the-year striped bass population dynamics. I. Model description and baseline simulations. *Trans. Amer. Fish. Soc.* 122: 415-438.
- Rose, K.A., H.I. Jager, W. Van Winkle, and R.G. Otto. 1997. Program on Compensatory Mechanisms in Fish Populations (CompMech): User's Guide to the Key Species Models. EPRI Report TR-109714. Prepared by Lockheed Martin Energy Research Corporation, Oak Ridge National Laboratory, Oak Ridge, Tennessee. Prepared for Electric Power Research Institute, Palo Alto, California.
- Rosen, B.H. 1995. Use of periphyton in the development of biocriteria, *in* *Biological Assessment and Criteria: Tools for Water Resource Planning and Decision Making* (W.S. Davis and T.P. Simon, eds), pp. 209-215. Lewis Publishers, Boca Raton, Florida.
- Ross, M.R. 1996. *Fisheries Conservation and Management*. Prentice-Hall Publishers. 274 pp.
- Rotenberry, J.T., and J.A. Wiens. 1985. Statistical over analysis and community-wide patterns. *The American Naturalist* 125:164-168.

- Rothschild, B.J. 1986. *Dynamics of Marine Fish Populations*. Harvard University Press, Cambridge, Massachusetts. 277 pp.
- Rothschild, B.J. 1998. Recruitment and population dynamics process, *in* *The Sea* (K.H. Brink and A.R. Robinson, eds.), pp. 293-325. Volume 10. John Wiley and Sons, Inc. New York.
- Royce, W.F. 1972. *Introduction to the Fishery Sciences*. Academic Press, Inc., New York.
- Saila, S.B., and E. Lorda. 1977. Sensitivity analysis applied to a matrix model of the Hudson River striped bass population, *in* *Assessing the Effects of Power-Plant Induced Mortality on Fish Populations* (W. Van Winkle, ed.), pp. 311-332. California, 5-7 May 1980. Proceedings of a conference in Gatlinburg, Tennessee, May 1977. Pergamon Press, New York.
- Saila, S.B., X. Chen, K. Erzini, and B. Martin. 1987. Compensatory Mechanisms in Fish Populations: Literature Reviews. Volume 1: Critical Evaluation of Case Histories of Fish Populations Experiencing Chronic Exploitation of Impact. EPRI EA-5200, Volume 1, Research Project 1633-6. Final Report. May.
- Saila, S.B., E. Lorda, J.D. Miller, R.A. Sher, and W.H. Howell. 1997. Equivalent adult estimates for losses of fish eggs, larvae, and juveniles at Seabrook Station with use of fuzzy logic to represent parametric uncertainty. *N. Amer. J. Fish. Manage.* 17:811-825.
- Sampson, P.D., and P. Guttorp. 1991. Power transformations and tests of environmental impact as interaction effects. *The American Statistician* 45(2):83-89.
- San Diego Gas and Electric (SDG&E). 1980. Silvergate Power Plant Cooling Water Intake System Demonstration (In Accordance with Section 316(b) Federal Water Pollution Control Act Amendment of 1972). Prepared for California Regional Water Quality Control Board, San Diego Region.
- Savidge, I.R., J.B. Gladden, K.P. Campbell, and J.S. Ziesnis. 1988. Development and sensitivity analysis of impact assessment equations based on stock-recruitment theory, *in* *Science, Law, and Hudson River Power Plants: A Case Study in Environmental Impact Assessment*, pp. 191-203. American Fisheries Society, Bethesda, Maryland.
- Schreck, C.B., and P.B. Moyle, eds. 1990. *Methods for Fish Biology*. American Fisheries Society, Bethesda, Maryland. 684 pp.



- Science Applications, Inc. 1982. *Proceedings: Workshop on Compensatory Mechanisms in Fish Populations*. EPRI EA-2762, Research Project 1633-2. Prepared by Science Applications, Inc., Oak Ridge, Tennessee. December.
- Sharp, G.D. 1987. Averaging the way to inadequate information in a varying world. *Amer. Inst. Fish. Res. Biol. Briefs* 16:3-4.
- Shepherd, J.G. 1982. A versatile new stock recruitment relationship for fisheries, and the construction of sustainable yields curve. *J. Cons. Int. Explor. Mer.* 40:67-75.
- Shirazi, M.A., and L.R. Davis. 1974. Workbook of Thermal Plume Prediction. Volume 2: Surface Discharge. Environmental Protection Tech. Series, EPA-R2-72-005b.
- Shirazi, M.A., and L.R. Davis. 1976. Analysis of buoyant surface jets. *J. Heat Transfer* 98(3). August.
- Shumway, R.H. 1988. *Applied Statistical Time Series Analysis*. Prentice Hall, Englewood Cliffs, New Jersey. 379 pp.
- Simon, T.P., and J. Lyons. 1995. Application of the index of biotic integrity to evaluate water resource integrity in freshwater ecosystems, *in* *Biological Assessment and Criteria: Tools for Water Resources Planning and Decision Making* (W.S. Davis and T.P. Simon, eds.), pp. 245-262. Lewis Publishers, Boca Raton, Florida.
- Southern California Edison Company (SCE). 1982. Southern California Edison Company 316(b) Demonstration. Technical Appendix: Impact Assessment Model Bight-Wide Plankton Investigation. Prepared for California Regional Water Quality Control Board, Los Angeles Region, San Diego Region, Santa Ana Region.
- Springer, T.A., B.R. Murphy, S. Gutreuter, R.O. Anderson, L.E. Miranda, D.C. Jackson, and R.S. Cone. 1990. Properties of relative weight and other condition indices. *Trans. Amer. Fish. Soc.* 119:1048-1058.
- Steedman, R.J. 1987. Modification and assessment of an index of biotic integrity to quantify stream quality in southern Ontario. *Can. J. Fish. Aquat. Sci.* 45, 492-501.
- Stewart-Oaten, A., W.M. Murdock, and K.R. Parker. 1986. Environmental impact assessment: "Pseudoreplication" in time? *Ecology* 67:929-940.
- Stone & Webster Engineering. 1994. Research Update on Fish Protection Technologies for Water Intakes. EPRI Report TR-104122.

- Strange, R.J., and J.C. Pelton. 1987. Nutrient content of clupeid forage fishes. *Trans. Amer. Fish. Soc.* 116:60-66.
- Stribling, J.B., B.D. Snyder, and W.S. Davis. 1996. Biological Assessment Methods, Biocriteria, and Biological Indicators. Bibliography of Selected Technical, Policy, and Regulatory Literature. EPA 230-B-96-001. Office of Policy, Planning, and Evaluation, Washington, D.C.
- Stroup, C.F., R.J. Hochberg, and S.P. Schreiner. 1992. Technical Review and Permitting of the Thermal Discharge and Water Intake Structures for the DP&L Indian River Power Plant. Prepared for Delaware Department of Natural Resources and Environmental Control. 28 February.
- Summers J.K. 1989. Simulating the indirect effects of power plant entrainment losses on an estuarine ecosystem. *Ecol. Modell.* 49:31-47.
- Suter, G.W. II. 1993. *Ecological Risk Assessment*. Lewis Publishers, Ann Arbor, Michigan. 538 pp.
- Suter, G., and S. Bartell. 1993. Ecosystem-level effects, *in Ecological Risk Assessment* (G.W. Suter, ed.), pp. 275-310. Volume 1, first edition. Lewis Publishers, Boca Raton, Florida.
- Suter, G.W., L.W. Barnthouse, S.M. Bartell, T. Mill, D. Mackay, and S. Paterson. 1993. *Ecological Risk Assessment*. First Edition. Lewis Publishers, Boca Raton.
- Sutton, T.M. 1997. Early Life History Dynamics of a Stocked Striped Bass (*Morone saxatilis*) Population and Assessment of Strategies for Improving Stocking Success in Smith Mountain Lake, Virginia. Doctoral Dissertation. Virginia Polytechnic Institute and State University, Blacksburg, Virginia.
- Swaine, M.D., and P. Greig-Smith. 1980. An application of principal components analysis to vegetation change in permanent lots. *Journal of Ecology* 68:33-41.
- Swingle, H.S. 1950. Relationships and Dynamics of Balanced and Unbalanced Fish Populations. Auburn Univ. Agric. Exp. Stn. Bull. 274. 74 pp.
- SYSTECH Engineering, Inc. 1987. Compensatory Mechanisms in Fish Populations: Literature Reviews. Volume 3: A Critical Review of Mathematical Models for Fish Compensation Mechanisms. EPRI Report EA-5200.
- Tenera Environmental Services. 1988. Diablo Canyon Power Plant Cooling Water Intake Structure 316(b) Demonstration. Prepared for Pacific Gas and Electric Company, 28 April.

- Ter Braak, C.J.f., and I.C. Prentice. 1988. A theory of gradient analysis. *Advances in Ecological Research* 18:271-317.
- Tetra Tech, Inc. 1996. Examination of the Effects of Habitat Quality, Land Use, and Acidification on the Macroinvertebrate Communities of Coastal Plain Streams. Prepared for the Power Plant Research Program, Chesapeake Bay Research and Monitoring Division, Maryland Department of Natural Resources.
- Tetra Tech, Inc. 1997. Power Plant Intake Systems Database Bibliography. EPRI TR-109273-DK. Final Report. November.
- The Cadmus Group, Inc. and Center for Watershed Protection. 1996. Final Report: Framework for a Watershed Management Program. Project 93-IRM-4.
- Texas Instruments, Inc. 1976. Hudson River Ecological Study in the area of Indian Point. Thermal Effects Report. Prepared for Consolidated Edison Company of New York, Inc.
- Timmons, T.J., W.L. Shelton, and W.D. Davis. 1980. Differential growth of largemouth bass in West Point Reservoir, Alabama-Georgia. *Trans. Amer. Fish. Soc.* 109(2):176-186.
- Toft, C.A., and P. J. Shea. 1983. Detecting community-wide patterns: estimating power strengthens statistical inference. *The American Naturalist* 122(5):618-625.
- Tong, Y.L. 1983. Some distribution properties of the Sample Species-Diversity Indices and their applications. *Biometrics* 39, 999-1008.
- U.S. Environmental Protection Agency (U.S. EPA). 1974. 316(a) Technical Guidance - Thermal Discharges. Water Planning Division, Office of Water and Hazardous Materials, EPA, Washington, D.C. September.
- U.S. EPA. 1977. Interagency 316(a) Technical Guidance Manual and Guide for Thermal Effects Sections of Nuclear Facilities Environmental Impact Statements. U.S. EPA, Office of Water Enforcement Permits Division, Industrial Permits Branch, Washington, D.C. May. Draft.
- U.S. EPA. 1983. Technical Support Manual: Waterbody Surveys and Assessments for Conducting Use Attainability Analyses. Volumes 1 through 3. Offices of Water Regulations and Standards, Washington, D.C.
- U.S. EPA. 1989. Rapid Bioassessment Protocols for Use in Streams and Rivers: Benthic Macroinvertebrates and Fish. EPA/440/4-89-001 (previously published as

---

References

- EPA/444/4-89-0001). U.S. Environmental Protection Agency, Office of Water, Washington, D.C. May.
- U.S. EPA. 1990. Biological Criteria: National Program Guidance for Surface Waters. EPA 440-5-90-0004. U.S. EPA, Office of Water Regulations and Standards. Washington, D.C.
- U.S. EPA. 1991. Biological Criteria: Research and Regulation. Proceedings of a Symposium. EPA-440/5-91-005. Office of Water, Washington, D.C.
- U.S. EPA. 1993. Fish Field and Laboratory Methods for Evaluating the Biological Integrity of Surface Waters. EPA/600-R-92/111. U.S. EPA, Office of Research and Development, Washington, DC.
- U.S. EPA. 1996a. Proposed guidelines for ecological risk assessment; notice. *Federal Register* 61(175):47552-47631.
- U.S. EPA. 1996b. Summary of State Biological Assessment Programs for Streams and Rivers. EPA 230-R-96-007. Office of Policy, Planning, and Evaluation, Washington, D.C.
- U.S. EPA. 1997a. Ecological Risk Assessment Guidance for Superfund: Process for Designing and Conducting Ecological Risk Assessment, Interim Final. Solid Waste and Emergency Response. EPA 540-R-97-006. June.
- U.S. EPA. 1997b. Field and Laboratory Methods for Macroinvertebrate and Habitat Assessment of Low Gradient, Nontidal Streams. Mid-Atlantic Coastal Streams Workgroup (MACS), Environmental Services Division, Region 3, Wheeling, West Virginia. 23 pp. with appendices.
- U.S. EPA. 1998a. Guidelines for Ecological Risk Assessment. EPA/630/R-95/002F. April.
- U.S. EPA. 1998b. Lake and Reservoir Bioassessment and Biocriteria; Technical Guidance Document. EPA-841-B-98-007.
- Utility Water Act Group (UWAG). 1978. *Biological Effects of Once-Through Cooling*. Volumes 1 through 5.
- Van Belle, G., and J. P. Hughes. 1984. Nonparametric tests for trend in water quality. *Water Resour. Res.* 20:127-136.

- Van Ness, K., K. Brown, M.S. Haddaway, D. Marshall, and D. Jordahl. 1997. Montgomery County Water Quality Monitoring Program Stream Monitoring Protocols. Department of Environmental Protection, Rockville, Maryland.
- Van Winkle, W. 1977. *Proceedings of the Conference on Assessing the Effects of Power-Plant-Induced Mortality on Fish Populations*. 3-6 May. Pergamon Press, New York.
- Van Winkle, W. 1981. Position Paper: Population-level assessments should be emphasized over community/ecosystem-level assessments, *in Issues Associated With Impact Assessment: Proceedings of the Fifth National Workshop on Entrainment and Impingement* (L.D. Jensen, ed.). EA Engineering, Science, and Technology, Inc. and EPRI.
- Van Winkle, W., and V.H. Dale. 1998. Model interactions: a reply to Aber. *ESA Bulletin* 79(4):257-259.
- Van Winkle, W., K.A. Rose, and R.C. Chambers. 1993a. Individual-based approach to fish population dynamics: An overview. *Trans. Amer. Fish. Soc.* 122:397-403.
- Van Winkle, W., K.A. Rose, K.O. Winemiller, D.L. DeAngelis, S.W. Christensen, R.G. Otto, and B.J. Shuter. 1993b. Linking life history theory and individual-based modeling to compare responses of different fish species to environmental change. *Trans. Amer. Fish. Soc.* 122:459-466.
- Vaughn, D.S. 1981. An age structure model of yellow perch in western Lake Erie, *in Quantitative Population Dynamics* (D.G. Chapman and V.F. Gallucci, eds.), pp. 189-216. International Co-Operative Publishing House, Fairland, Maryland.
- Vaughn, D.S., and S.B. Saila. 1976. A method for determining mortality rates using the Leslie matrix. *Trans. Amer. Fish. Soc.* 105:380-383.
- Vaughn, D.S., R.M. Yoshiyama, J.E. Breck, and D.L. DeAngelis. 1982. Review and Analysis of Existing Modeling Approaches for Assessing Population-Level Effects of Multiple Stresses on Fish and Shellfish. Oak Ridge National Laboratory, Environmental Sciences Division Publication No. 1979, Oak Ridge, Tennessee. ORNL/tm-8342. Prepared for U.S. Fish and Wildlife Service, Office of Biological Services, Kearneysville, West Virginia.
- Vaughn, D.S. 1988. Section 3: Entrainment and Impingement Impacts. Introduction, *in Science, Law, and Hudson River Power Plants: A Case Study in Environmental Impact Assessment* (L.W. Barnthouse, R.J. Klauda, D.S. Vaughan, and R.L. Kendall, eds.). American Fisheries Society, Bethesda, Maryland.

- Versar, Inc., A.F. Holland, S.B. Weisberg, J.K. Summers, L.R. Cadman, and J.M. Hoenig. 1989a. Technical Review and Evaluation of Thermal Effects Studies and Cooling Water Intake Structure Demonstration of Impact for the Salem Nuclear Generating Station: Revised Final Report. Prepared for New Jersey Department of Environmental Protection, Division. of Water Resources, Trenton, New Jersey.
- Versar, Inc. 1989b. Review and Evaluation of PEPCO's 1989 Fractional Entrainment Loss Estimates for the Chalk Point SES. Prepared for Power Plant and Environmental Review Division, Tidewater Administration, Maryland Department of Natural Resources, Annapolis, Maryland. 24 August.
- Versar, Inc., J.K. Summers, A.F. Holland, S.B. Weisberg, L.C. Wendling, C.F. Stroup, R.L. Dwyer, M.A. Turner, and W. Burton. 1989c. Review and Evaluation of PEPCO's 1989 Fractional Entrainment Loss Estimates for the Chalk Point SES. Prepared for Power Plant and Environmental Review Division, Tidewater Administration, Maryland Department of Natural Resources, Annapolis, Maryland. 24 August.
- Versar, Inc., J.K. Summers, A.F. Holland, S.B. Weisberg, L.C. Wendling, C.F. Stroup, R.L. Dwyer, M.A. Turner, and W. Burton. 1989d. Technical Review and Evaluation of Thermal Effects Studies and Cooling Water Intake Structure Demonstration of Impact for the Oyster Creek Nuclear Generating Station. Revised Final Report. Prepared for New Jersey Department of Environmental Protection, Trenton, New Jersey.
- Walpole, R.E., and R. H. Myers. 1972. *Probability and Statistics for Engineers and Scientists*. Macmillan Company, New York. 506 pp.
- Walpole, R.E., R.H. Myers, and S.L. Myers. 1998. *Probability and Statistics for Engineers and Scientists*. Prentice Hall, Englewood Cliffs, New Jersey.
- Walton, W.E., S.M. Compton, J.D. Allan, and J.E. Daniels. 1982. The effect of acid stress on survivorship and reproduction of *Daphnia pulex* (Crustacea: Cladocer). *Can. J. Zool.* 60:573-579.
- Wege, G.J., and R.O. Anderson. 1978. Relative weight ( $W_r$ ): A new index of condition for largemouth bass, in *New Approaches to the Management of Small Impoundments* (G.D. Novinger and J.G. Dillard, eds.), pp. 79-91. Special Publication 5. North Central Division, American Fisheries Society, Bethesda, Maryland.
- Weisberg, S.B., J.A. Ranasinghe, D.M. Dauer, L.C. Schaffner, R.J. Diaz, J.B. Frithsen. 1997. An estuarine benthic index of biotic integrity (B-IBI) for Chesapeake Bay. *Estuaries* 20(1):149-158.

- West Virginia. 1998. 1998 303(d) Listing - Decision Support Information. West Virginia Division of Environmental Protection.
- Westfall, P.H., and S.S. Young. 1993. *Resampling-Based Multiple Testing: Examples and Methods for p-Value Adjustment*. John Wiley and Sons, Inc., New York. 340 pp.
- Whittier, T.R. 1999. Development of IBI metrics for lakes in Southern New England, in *Assessing the Sustainability and Biological Integrity of Water Resources Using Fish Communities* (T.P. Simon, ed.), pp. 563-584. CRC Press.
- Wiens, J.A., and K. R. Parker. 1995. Analyzing the effects of accidental environmental impacts: approaches and assumptions. *Ecological Applications* 5(4):1069-1078.
- Winemiller, K.O., and K.A. Rose. 1992. Patterns of life-history diversification in North American fishes: Implications for population regulation. *Can. J. Fish. Aquat. Sci.* 49:2196-2218.
- Woodis Associates. 1994. Summary of EPRI Cooling System Effects Research, 1975-1993. Topical Report TR-104302.
- Yoder, C.O., P. Albiet, and M.A. Smith. 1981. The distribution and Abundance of Fishes in the Mainstem Scioto River as Affected by Pollutant Loadings. Ohio EPA Technical Rept. 81/3. Columbus.
- Yoshiyama, R.M., W. Van Winkle, B.L.Kirk, and D.E. Stevens. 1981. Regression Analyses of Stock-Recruitment Relationships in Three Fish Populations. ORNL/NUREG/TM-424. Oak Ridge National Laboratory, Oak Ridge, Tennessee.
- Zar, J.H. 1984. *Biostatistical Analysis*. 2nd edition. Prentice Hall, Englewood Cliffs, New Jersey.







*Target:*

316 (a) and (b) Fish Protection Issues

## **About EPRI**

EPRI creates science and technology solutions for the global energy and energy services industry. U.S. electric utilities established the Electric Power Research Institute in 1973 as a nonprofit research consortium for the benefit of utility members, their customers, and society. Now known simply as EPRI, the company provides a wide range of innovative products and services to more than 1000 energy-related organizations in 40 countries. EPRI's multidisciplinary team of scientists and engineers draws on a worldwide network of technical and business expertise to help solve today's toughest energy and environmental problems.

EPRI. Electrify the World

© 1999 Electric Power Research Institute (EPRI), Inc. All rights reserved. Electric Power Research Institute and EPRI are registered service marks of the Electric Power Research Institute, Inc. EPRI. ELECTRIFY THE WORLD is a service mark of the Electric Power Research Institute, Inc.

 Printed on recycled paper in the United States of America

TR-112013